

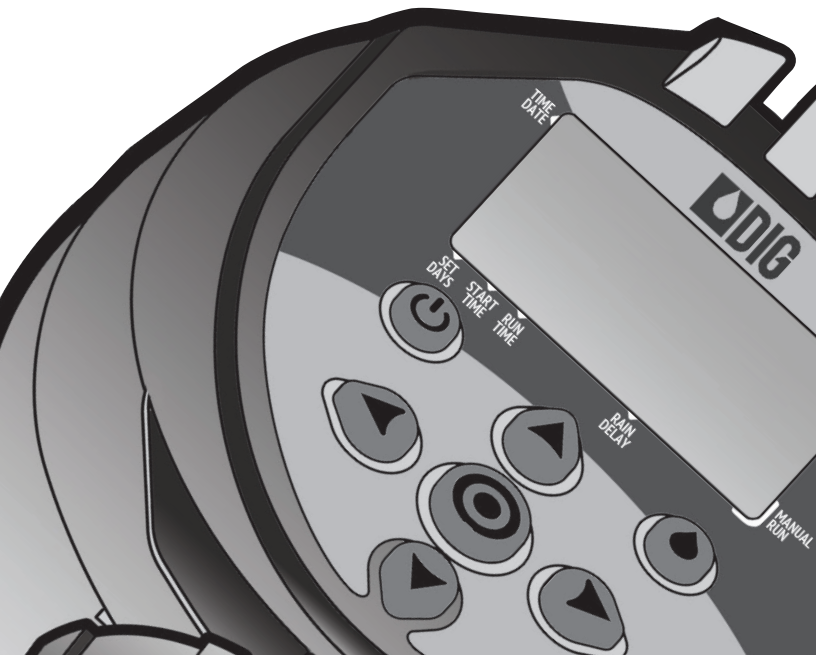

water matters

400A Series Single Station Irrigation Battery Operated Controller

400A-000 | 400A-XXX



I N S T R U C T I O N M A N U A L

TABLE OF CONTENTS

1.	Introduction	1
2.	About the 400A Series battery operated controller	1
3.	Component identification	2
4.	LCD display and controls	3
5.	Installing the batteries	4
6.	Valve adapter installation	5
7.	In-line valve installation	7
8.	Programming.....	8
9.	Setting current time and date	8
10.	Setting watering day schedules	10
11.	Setting watering start times	13
12.	Setting watering run times (program(s) duration)	15
13.	Setting rain delay – optional feature	16
14.	Manual watering	18
15.	Connecting a rain sensor	19
16.	Changing the batteries	20
17.	Maintenance, troubleshooting and repairs	20
18.	Warranty	23
19.	Technical assistance	24
20.	To order replacement or spare parts	25

1. INTRODUCTION

Thank you for purchasing DIG's 400A Series Single Station Battery Powered Controller. This manual describes how to get the 400A Series controller up and running quickly. After reading this manual and becoming familiar with the basic functionality of the controller, use the manual as a reference for less common tasks in the future.

2. ABOUT THE 400A SERIES BATTERY OPERATED

The 400A Series watering controller employs the latest irrigation programming features to allow for complete control of any irrigation system and comes assembled on an in-line valve or the controller only with adapters to fit most manufacturers valves. The 400A Series is available in single station with a rain sensor connection, and is powered by two AA batteries that can last up to 3 years [using name brand alkaline batteries]. The controller is enclosed in a compact, waterproof housing to protect it from the elements.

3. COMPONENT IDENTIFICATION

1. Controller cover
2. Quick reference label
3. LCD Display displays the icon-based applications/ programs
4. 7 button programming keypad: Use for programming, system on/off, manual run and reviewing program
5. Battery compartment cap for two AA alkaline batteries (not included)
6. Rain sensor yellow wire connection
7. Collapsible 36 in. solenoid wire
8. DC solenoid
9. Solenoid adapters
10. Manual flow control
11. 3/4 in. professional grade in-line valve

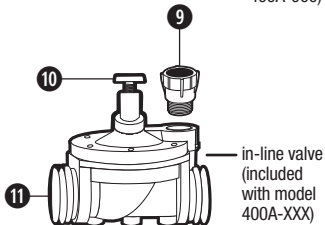
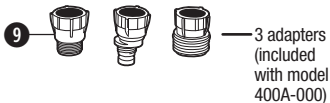
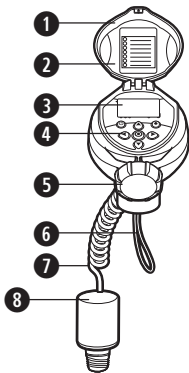



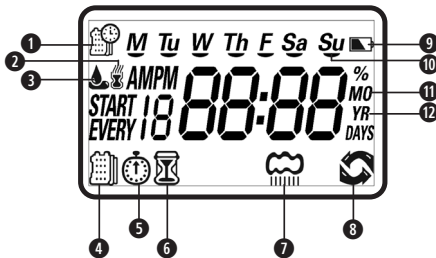

4. LCD DISPLAY AND CONTROLS



LCD Display

1. **Time and Date Icon** – Indicates current time and day is displayed
2. **Sensor Icon** – Appears when a rain sensor is active or when yellow wire loop has been cut and watering is halted
3. **Watering Icon** – Appears when valve is open
4. **Set Watering Days Icon** – Choose either specific days, odd/even days, every X hours, or up to once every 30 days
5. **Start Time Icon** – Up to 4 start times per day available
6. **Run Time Icon** – Watering duration from 1 minute to 5 hours and 59 minutes
7. **Rain Delay Icon** – Delay irrigation setting from 1 to 99 days with automatic restart
8. **Manual Run Icon** – Appears when manual button is pushed
9. **Battery Level Indicator** – Flashes when batteries are low and need to be replaced
10. **Day of the Week Underscore** – Shows which day of the week the controller will operate
11. **Represents Month**
12. **Represents Year**

Control Buttons

-  Select programming mode
-  Turn program(s) ON/OFF
-  Start/stop a manual cycle
-  Move left/right to select a value
-  Raise/lower the selected value

5. INSTALLING THE BATTERIES

1. Open the battery compartment cap by turning it counter-clockwise.
2. Install two, fresh, brand name, AA alkaline batteries (not included) and note the proper direction of the positive and negative orientation on the underside of the controller.
3. Insert and screw the battery cap clockwise. Make sure to securely tighten the cover firmly by hand only. The controller display appears with a day, PM, and the hour digit flashing. The controller is ready to be installed and programmed.

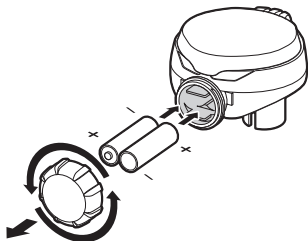

6. VALVE ADAPTER INSTALLATION 400A-000

The 400A-000 controller includes 3 adapters to retrofit Rainbird, Hunter and Toro valves. Follow the instructions below to install.









1. Shut off the main water supply
2. Remove the existing solenoid if applicable.
NOTE: If adapting to an IRRITROL valve, remove the solenoid but **leave the existing solenoid adapter installed.**
3. Select the appropriate solenoid adapter associated with the valve. (see chart A)
4. Screw the solenoid adapter into the valve bonnet by hand, tighten with pliers if necessary – but do not over tighten.
5. Thread the 400A Series solenoid into the valve adapter. Hand tighten only.
6. Turn the main water supply on and pressurize the valve; the valve may discharge water momentarily but should then shut off.
7. Test the controller and the installation by pressing the  button or see section 14 to perform a manual run. To turn the valve on via the solenoid, lift the 400A Series controller from the solenoid and turn the solenoid counter clockwise 1/2 to 3/4 of a turn, or until you hear or see water flowing through the valve. To turn the water off, turn the solenoid clockwise 1/2 to 3/4 of a turn and wait for the a few seconds for the valve to close.
8. Program the 400A Series controller (see section 8).

CHART A

Model		Compatible Valves
30-920*		BERMAD series 200, HIT series 500, DOROT series 80, GRISWOLD series 2000, DW and BUCKNER series VB valves
30-921+ INCLUDED		RAIN BIRD DV, DVF, PGA, PEB (1" only), GB, EFB-CP, BPE, PESB (1" only) and ASVF valves
30-922+ INCLUDED		HUNTER series ASV, HPV, ICV, PGV, SRV, IBV and ASVF valves
30-923*		WEATHERMATIC series 12000, 21000, 8200CR valves
30-924+ INCLUDED		IRRITROL series 100, 200B, 205, 217B, 700, 2400, 2500, 2600 and TORO series 220, P220 valves
30-925*		SUPERIOR series 950, HUNTER HBV and TORO series 252 valves (1.5" and larger)
30-926*		RAIN BIRD SERIES PEB AND PESB VALVES

*AVAILABLE THROUGH YOUR DISTRIBUTOR
+ 400A-000 ONLY

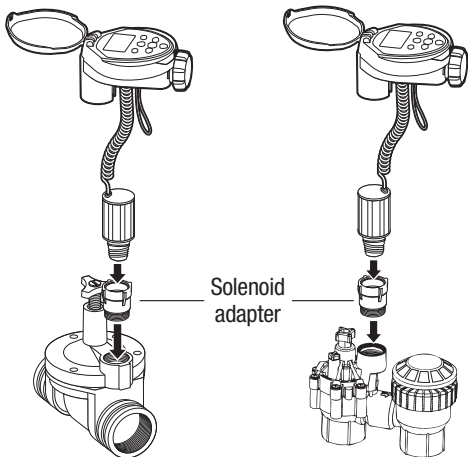

7. IN-LINE VALVE INSTALLATION 400A-XXX

Rated operating pressure: 10-125 PSI

Recommended Operating Pressure: 10-80 PSI

Warning: Wrap all fittings with Teflon tape! Do not use pipe cement on valve as this will damage the valve and void the warranty!

1. Shut off main water supply.
2. Install a 3/4 in. ball or gate valve onto the PVC pipe or to the valve manifold before installing the controller (Figure 1a and 1b).
3. Turn water supply on to flush the line and then shut the water off using the ball or gate valve.
4. Wrap the male threads of the PVC adapters with 4-6 layers of Teflon tape, then tighten into the valve with a wrench.
5. Glue fittings to PVC main line and allow to dry.
6. Turn water supply on to pressurize the system. The controller will open momentarily and then will shut off.

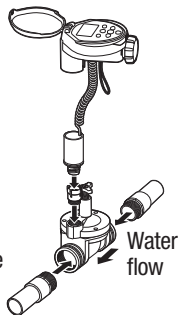

Figure 1a

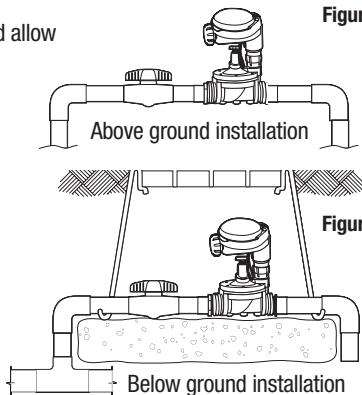





Figure 1b

8. PROGRAMMING

The 400A Series controller can be programmed to operate on any day of the week, odd days or even days. In cyclical mode the 400A Series can also operate from every 1 hour up to every 12 hours or from once a day up to every 30 days. The 400A Series has four start times per day and durations from 1 minute up to 5 hours and 59 minutes.

This section explains the programming features, and the steps necessary to assign irrigation schedules. To program the controller use the  to select the desired programming mode, the  to make the entry flash and the   buttons to change the value.

NOTE: Only a flashing value can be changed.

NOTE: If the last data entered stops flashing, press  again to resume programming and repeat the steps.

9. SETTING CURRENT TIME AND DATE

The controller can display the time in either a 12 or 24 hour format. To change the time format, from the home screen:

1. Press the  button for three seconds until the  display switches format (AM/PM disappears).







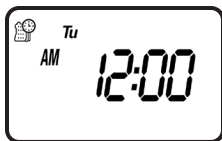

SETTING THE CURRENT TIME AND DATE

To enable the controller to operate properly, the current time and date must be set.

1. Press the  button, until the  icon appears along with the time and the day of the week.



2. If the current time has not been set or needs to be updated press  and the hour digit starts flashing.
3. To set the current hour, press  or  (note AM and PM designations).
4. To set the minutes, press  again and the minute digit starts flashing. Press the  or  to set the current time in minutes.

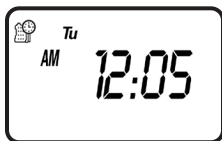

5. Repeat the steps to set the current date including, month, day and year. When the date is selected and updated, the day of the week will update at the same time to correspond with the date.

MONTH DAY YEAR

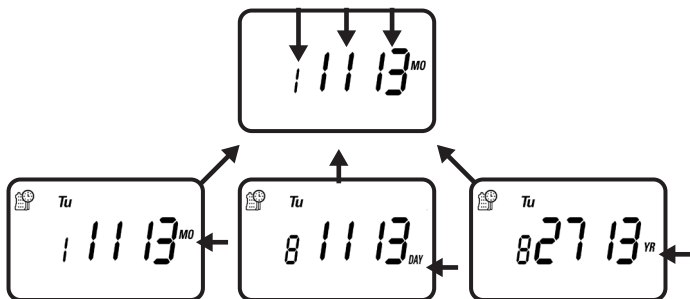

Press  to proceed to the next step, SET DAYS  or to review the program.

Press  to move backward.

10. SETTING WATERING DAY SCHEDULES







Option 1 – Setting Specific Days of the Week:

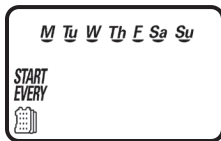

This setting determines which days the 400A Series controller will operate. Choose either watering on specific days of the week, EVEN/ODD days or cyclical from daily up to once every 30 days. The controller's default setting is to water on all specific days of the week.

For example, if you want to water every Tuesday, Thursday and Sunday:

1. Press the  button until the  icon and the days of the week appear on the screen.



2. Press  once and **M** (for Monday) starts flashing.
3. Press,  and underscore under **M** (Monday) disappears. Monday is de-selected.
4. Press  twice and **W** (for Wednesday) starts flashing.
5. Press  and the underscore under **W** (Wednesday) disappears. Wednesday is de-selected.
6. Press  twice and **F** (Friday) starts flashing.
7. Press  and the underscore under **F** (Friday) disappears. Friday is de-selected.



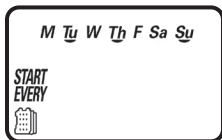

- Press  and the underscore under **Sa** (Saturday) starts flashing.
- Press  and the underscore under **Sa** disappears. Saturday is de-selected.



Option 2 – Setting Even or Odd Days:

To select **EVEN** days, **ODD** days refer to the example.

Example: setting the controller to water on ODD days

- Press the  button until the  icon and the days of the week appear.
- Press  and  to skip all the days of the week (underscore must be removed beneath all days).
- Press  and **EVEN** appears flashing.









- Press  and **ODD** appears flashing



Press the  button to proceed to the next step START TIME  or to review the program.

Option 3 – Setting every X hours:

Example: setting the controller to water every 7 hours





1. Press the  button until the  icon and the days of the week appear.
2. Press  and  to skip all the days of the week (underscore must be removed beneath all days).
3. Press  and EVEN appears flashing.
4. Press  again and 1:00 hour appears flashing. To select the number of hours between watering to 7 hours, press  until 7:00 appears on the display.



Press the  button to proceed to the next step START TIME  or to review the program.

Option 4 – Setting every X days:



Example: setting the controller to water every 10 days:

1. Press the  button until the  icon and the days of the week appear.
2. Press  and  to skip all the days of the week (underscore must be removed beneath all days).
3. Press  and EVEN appears flashing.

4. Press  again and 1 hour appears flashing.
5. Press  again and 1 DAY appears flashing. To select the number of days between watering to 10 days, press  until 10 appears on the display.



To set the controller back to specific days mode:

1. Push the  button until – *START EVERY* and the  icon appear at the bottom left of the screen.
2. Push the  until the days of the week appear at the top of the screen.

Press the  button to proceed to the next step *START TIME*  or to review the program.

11. SETTING WATERING START TIMES

The 400A Series controller can have up to four separate irrigation start times per day. (Note: if the controller is set to water every X hours, only one start time is available to be programmed.)

To set a start time,

1. Press the  button until the  icon appears. *START 1*, displays OFF or the last start time programmed in *START 1* appears.

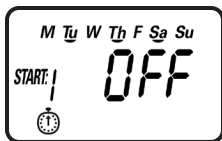

2. Press and OFF (or the first start time programmed) begins flashing.
3. To set the desired first start time hour (note AM and PM designations), press or .
4. Press and the minutes start flashing.
5. Press or and set the desired start time minutes.

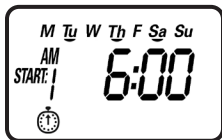

6. Press again, the second start time and OFF or the last start time programmed appear flashing. Repeat the steps to set the second, third, and if needed, the fourth start time. During programming, if you are set to water on specific days of the week, the screen also shows which days the controller will operate with an underline.

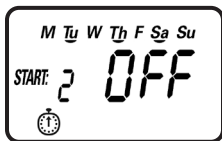

To delete a start time:

1. Press until START 1 appears.

2. Press  until the start time appears that you want to delete.

3. Press  until the word OFF appears.

Press the  button to proceed to the next step RUN TIME  or to review the program.

12. SETTING WATERING RUN TIMES (PROGRAM(S) DURATION)

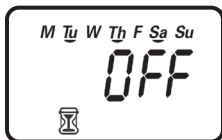

This setting determines the length of time the 400A Series controller will allow the valve to remain open (duration is from 1 minute up to 5 hours and 59 minutes). For example, setting watering run time to 10 minutes on certain days of the week will program the controller to turn the water on for 10 minutes on each of the days chosen and at every start time selected. (Note: if the controller is set to water every X hours, the maximum duration is 59 minutes)

To set the watering run time :





1. Press the  button until the  icon appears and OFF or the last run time setting appears. (OFF will appear if duration is set to 0)

2. Press the  button, and 0:00 (or the last run time programmed) appears with hours flashing.

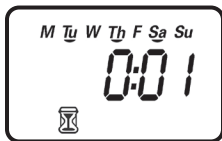
3. To set a desired watering run time in hours, press  or  and select the number of hours.



- If only watering duration in minutes is required, press  to skip the hour digit, and the minutes will start flashing.
- To set the desired watering duration in minutes (example of 10 minutes), press  or  to select minutes. When programming the watering duration, if you are set to water on specific days of the week, the screen will also show the days the controller will operate with an underline.

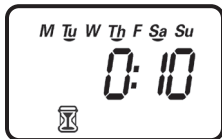

At this point the controller's normal programming is concluded.

Press the  button to proceed to the next step RAIN DELAY  or to review the program or to exit.



13. SETTING RAIN DELAY – OPTIONAL FEATURE

The Rain Delay setting is used to temporarily suspend all irrigation for a defined number of days. For example, during rainy weather regularly scheduled programs can be turned off from 1-99 days. At the end of the designated period, regularly scheduled programming will resume automatically.



To set a temporary suspension of the program:

- Press the  button until the  icon and OFF appear.



2. Press the  button and OFF starts flashing.
3. To set the desired temporary suspension of the program (1-99 days), press  or .



4. The temporary suspension of the program can be cancelled at any time by re-entering Rain Delay screen and changing the setting to OFF. (Press  or  until OFF appears.)

Note: OFF appears in between numeric value of 99 and 1.

Press the  button to review the program or to exit.

14. MANUAL WATERING

The manual mode allows the user to test the system and water for a specified run time set in watering duration. The controller will automatically stop watering at the end of the defined irrigation period. The originally programmed irrigation schedule continues to function at the times assigned. The sensor condition is disregarded in this mode.

To start a manual run,

1. Press the  button, and the  icon and  icon appears. ON appears momentarily and then the last watering duration is displayed with  .

The controller will open the valve and in 5 seconds a count down of the remaining irrigation duration appears, showing when the controller will close the valve.

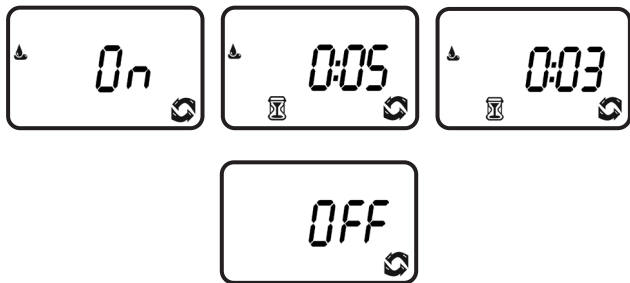

2. Press the  button to end manual run.
3. After 5 seconds the display will revert to the current time screen.

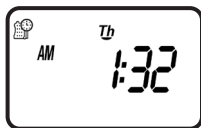

To activate a manual watering without the use of the controller – turn the solenoid a 1/4 turn counterclockwise. To stop, tighten the solenoid clockwise by hand only – do not over tighten (figure 2).

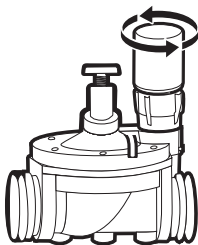

Figure 2

15. CONNECTING A RAIN SENSOR

Most “normally closed” rain sensors can be connected to the 400A Series controller.

The function of the sensor is to prevent automatic watering by the set program due to excessive rainfall.

To connect the sensor to the controller, please follow these steps:

1. Cut the yellow wire loop that exits the controller in the middle of the loop.
2. Strip approximately 1/2 in. of insulation from the end of each wire.
3. Splice one yellow wire to each of the wires coming from the sensor.
Use waterproof wire connectors to secure the connections.
4. When the sensor is active and preventing automatic operation, the ☂ icon will appear on the display.



The ☂ icon will only appear when sensor is active or if the wire has been cut.

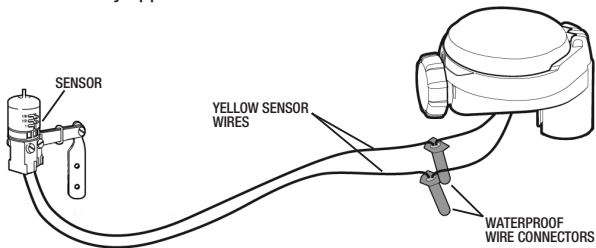

Recommended rain sensors are the Rain Bird RSD and Hunter Mini-Clik

16. CHANGING THE BATTERIES

The 400A Series controller's batteries can last up to 3 years when using name-brand AA alkaline batteries. Actual battery life will depend on the sensitivity of the installed batteries to temperature ranges experienced by the controller as well as the number of valve operations programmed per day. To ensure proper operation, it is recommended that the 400A Series controller be checked regularly and the batteries replaced once the low battery indication starts flashing.



The 400A Series controller is designed to maintain the current time settings for up to 60 seconds with the batteries removed.

To change the batteries, see section 5.

Note: If the batteries are dead or drained, manual operation can also be accomplished by turning the solenoid counterclockwise, or by turning the external bleed screw counterclockwise. This will cause the valve to open. Both must be turned clockwise to close the valve.

17. MAINTENANCE, TROUBLESHOOTING AND REPAIRS

To restore the controller to the **default** settings

1. Press the  button until the **START EVERY** is displayed and the  icon appears on the bottom left of the screen.
2. Press and hold down the  for three seconds.
3. The screen returns to the home screen (clock) and all the default settings are restored. The current time and date is retained.

PROBLEM: Controller fails to open automatically or manually

CAUSE: No water pressure

SOLUTION: Open main water supply valve

CAUSE: Flow control knob is turned down

SOLUTION: Turn flow control knob clockwise to open

PROBLEM: Valve/actuator functions via the manual mode but not automatically

CAUSE: Controller is set to OFF mode

SOLUTION: Verify that the controller does not show OFF in current time mode

CAUSE: AM/PM not set correctly in current time mode

SOLUTION: Check current time, change AM/PM if necessary

CAUSE: AM/PM not set correctly in start time mode

SOLUTION: Check start time(s), change AM/PM if necessary

CAUSE: Rain delay is preventing watering

SOLUTION: Set rain delay to off

CAUSE: Yellow sensor wires have been cut

SOLUTION: Re-connect sensor wires together with waterproof connector

CAUSE: Sensor is installed and is in a state that prevents watering

SOLUTION: Check sensor and wire splices and verify sensor is normally closed

PROBLEM: The display is blank

CAUSE: No buttons have been pushed in the previous 15 minutes

SOLUTION: Push any button

PROBLEM: Valve fails to close

CAUSE: Solenoid is loose

SOLUTION: Tighten solenoid by turning it clockwise to the right

CAUSE: Valve is installed backwards

SOLUTION: Check flow arrow and verify arrows points away from
water source – reverse valve if necessary

CAUSE: Debris is blocking solenoid port

SOLUTION: Shut off water supply, unscrew and remove solenoid, then open
water supply and flush out solenoid port, re-install solenoid

CAUSE: Flow control knob is too far open

SOLUTION: Turn flow control knob clockwise and retest

CAUSE: Drip System flow rate is below minimum flow rate

SOLUTION: Increase system flow rate by adding or changing drippers

PROBLEM: Rain sensor does not prevent watering

CAUSE: Rain sensor is normally open, malfunctioning, or not wired correctly

SOLUTION: Verify that sensor icon appears on display when pin is pushed down and check all wire splices

PROBLEM: Controller waters more than once per day

CAUSE: More than one start time has been programmed

SOLUTION: Change start time 2, 3, 4, and 5 to OFF

18. WARRANTY

DIG CORPORATION warrants these products to be free from defects in material and workmanship for a period of three years from date of purchase. This warranty does not cover damage resulting from accident, misuse, neglect, modification, improper installation or subjection to line pressure in excess of 125 lbs. per square inch for anti-siphon valves, in-line valves and for actuators. This warranty shall extend only to the original purchaser of the product for use by the purchaser.

The obligation of DIG CORPORATION under this warranty is limited to repairing or replacing at its factory this product which shall be returned to the factory within three years after the original purchase and which on examination is found to contain defects in material and workmanship. **DIG CORPORATION SHALL IN NO EVENT BE LIABLE FOR ANY INCIDENTAL OR CONSEQUENTIAL DAMAGES OF ANY KIND; THE SOLE OBLIGATION OF DIG BEING LIMITED TO REPAIR OR REPLACEMENT OF DEFECTIVE PRODUCTS. SOME STATES DO NOT ALLOW THE EXCLUSION OR LIMITATION OF INCIDENTAL OR CONSEQUENTIAL DAMAGES, SO THE ABOVE LIMITATION OR EXCLUSION MAY NOT APPLY TO YOU.**

Unattended use for prolonged periods without inspection to verify proper operation is beyond the intended use of this product, and any damage resulting from such use shall not be the responsibility of DIG CORPORATION. There are no warranties, which extend beyond the description on the face hereof. In the case of purchase of the product for use other than, for irrigation purposes, DIG CORPORATION hereby disclaims any implied warranties including any warranties of merchantability and fitness for a particular purpose. In the case of the purchase of the product for personal, family or household purposes, DIG CORPORATION disclaims any such warranties to the extent permitted by law. To the extent that any such disclaimer or implied warranties shall be ineffectual, then any implied warranties shall be limited in duration to a period of three years from the date of the original purchase for use by the purchaser. Some states do not allow limitation on how long an implied warranty lasts, so the above limitation may not apply to you.

In order to obtain performance under this warranty, the unit must be returned to the factory, along with proof of purchase indicating original date of purchase, shipping prepaid, addressed as follows:

DIG CORPORATION, 1210 Activity Drive, Vista, CA 92081. Repaired or replaced units will be shipped prepaid to the name and address supplied with the unit returned under warranty. Allow four weeks for repairs and shipping time. Repair of damaged units not otherwise within warranty may be refused or done at a reasonable cost or charge at the option of DIG CORPORATION.

This warranty gives you specific legal rights, and you may also have other rights, which vary from state to state.

19. TECHNICAL ASSISTANCE

Should you encounter any problem(s) with this product or if you do not understand its many features, please refer to this operating manual first. If further assistance is required DIG offers the following customer support:

DIGPRO™ Technical Service USA

DIG's Technical Service Team is available to answer questions in English and Spanish from 8:00 AM to 5:00 PM (PST) Monday-Friday (except holidays) at 800-344-2281.

Questions can be e-mailed to questions@digcorp.com or faxed to 760-727-0282.

Specification documents and manuals are available for download at www.digcorp.com.

Customer Assistance Outside the USA

Contact your local distributor.

20. TO ORDER REPLACEMENT OR SPARE PARTS: PLEASE ORDER ONLINE AT WWW.DIGCORP.COM

We at DIG Corporation understand that most dealers do not carry spare parts. For your convenience, if you need one of these parts, please order online at www.digcorp.com.

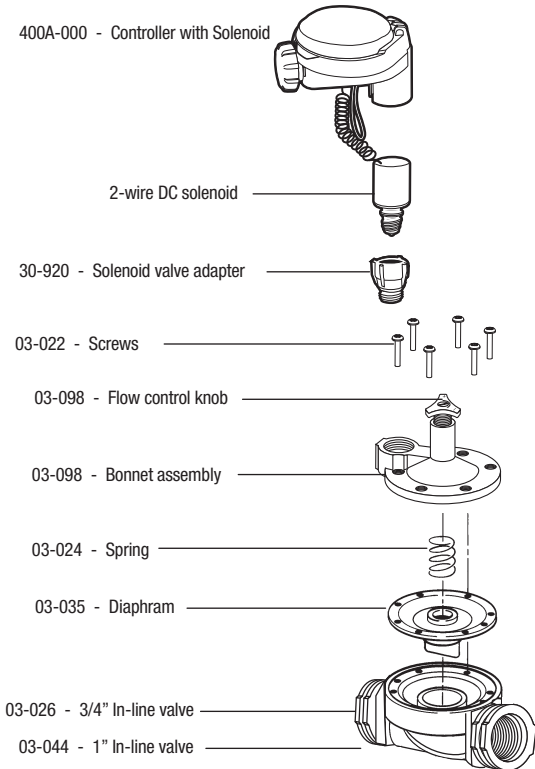



1210 Activity Drive
Vista, CA 92081-8510, USA

Website:

www.digcorp.com

e-mail: dig@digcorp.com

26-230 REVC 010720

Printed in the USA

DIG is a Registered Service Mark of DIG Corp.

