

Ages 8+

RED5

THE ILLUMINATOR

LIGHT UP DRONE

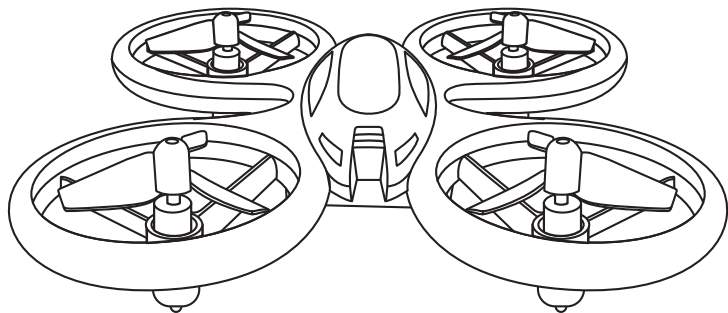

Please read this instruction manual carefully and retain this information for future use.

1. Product Contents

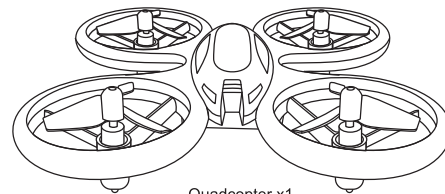

Quadcopter x1

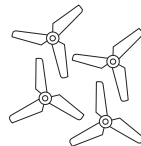

Spare Rotary Blades x4

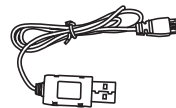

USB Charger x1

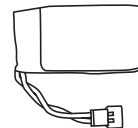

Battery x1

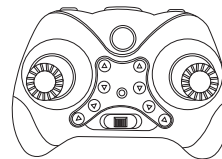

Remote Control x1



Instruction Book x1

1.1 The Quadcopter

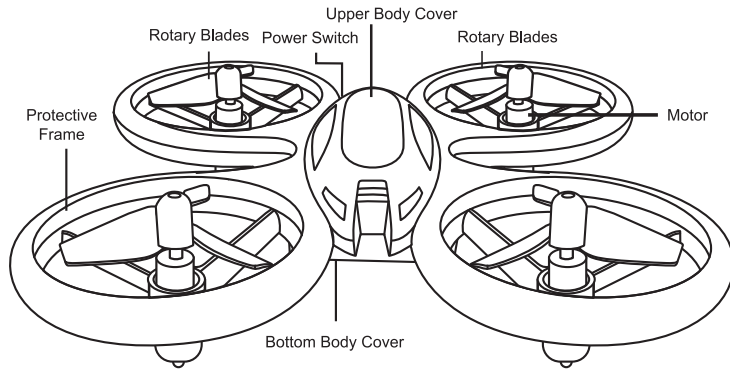

2. The Remote Control

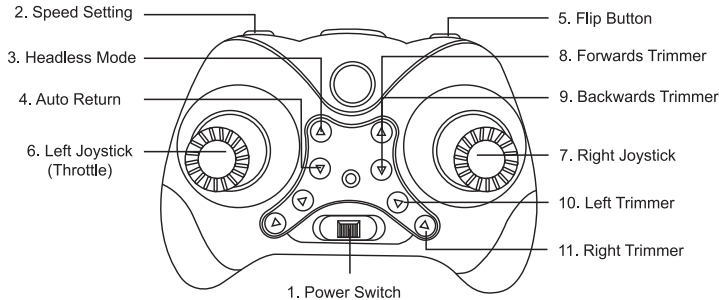

Power Switch	Push the power switch to the right to turn ON the remote control. Push the power switch to the left to turn OFF the remote control.
Speed Setting	The quadcopter has three different speed settings. Press the speed setting button once to put the quadcopter into the slowest speed setting, the remote will beep once to indicate it is in the slowest speed setting. Press the button for a second time to put the quadcopter into the middle speed setting, the remote will then beep twice. Press the button for a third time to put the quadcopter into the fastest speed setting, the remote will then beep three times.
Headless Mode	The quadcopter's direction of flight seen from your viewpoint follows the controls directly, no matter in which direction the quadcopter is pointing. So if you press the lever on the controller to the left the quadcopter will fly to the left from your viewpoint. Without headless mode the quadcopter would fly to the direction which is on the left side of the quadcopter, so if the quadcopter is pointing towards you it would fly to the right. How to turn on the headless mode: Press the headless mode button once and the quadcopter will enter into headless mode. Press the button again to exit headless mode.
Auto Return	This will make the quadcopter return automatically to the user.
Flip Button	Press for 360° flips.
Left Joystick (Throttle)	Up/down/left/right turn.
Right Joystick	Forwards/backwards, left/right fly.
Forwards/Backwards Trimmer	Pressing this key can stabilize the drone if it diverts backwards. Pressing this key can stabilize the drone if it diverts forwards.
Left/Right Trimmer	Pressing this key can stabilize the drone if it diverts to the right. Pressing this key can stabilize the drone if it diverts to the left.

2.2 Remote Control Battery Installation

Unscrew the back of the battery cover, slide the cover down and off to open the battery compartment. Insert 3x AAA batteries according to the correct polarities. Replace battery cover.

3x1.5V AAA batteries

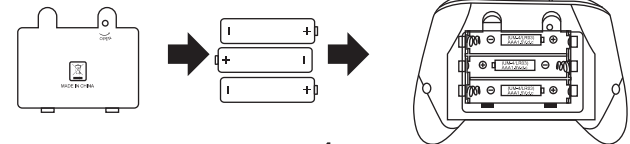

3. Charging the Quadcopter Battery

Remove the battery from the quadcopter. Connect the battery to the USB charging cable, then connect the USB plug to a computer's or an adapter's USB port. When charging, the USB's indicator light will turn on. When the battery is fully charged, the indicator light will turn off.

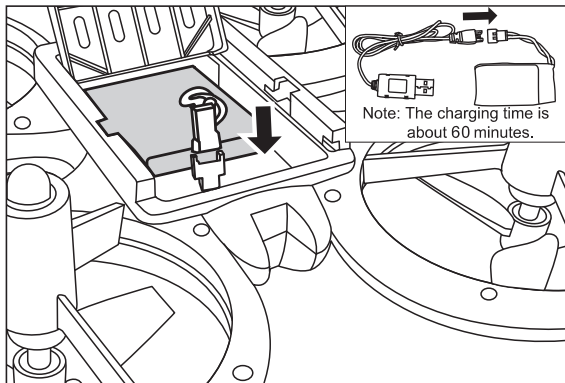

Caution:

Battery Charging Precautions:

- Do not leave the battery unattended while charging.
- The charging process and battery replacement should only be completed by an adult.
- Store the battery in a cool, dry and well ventilated area.
- Do not expose the battery or charger to direct heat, light or water sources.
- Do not dismantle the battery.
- Ensure the battery has cooled sufficiently before re-charging. Charging the battery while it is still hot/warm could cause swelling and damage to the battery. If swelling does occur, do not attempt to charge or use the battery. Dispose of the battery appropriately and replace with a new battery.
- Please remove the battery from the product before charging.
- Please remove the battery from charge once the battery is fully charged. Overcharging the battery could cause battery swelling, and can shorten the lifespan of the battery.
- Only use the charger provided.

4. Blade Installation

4.1 Installation

Use the spare rotary blades provided if one of the rotary blades on the quadcopter becomes damaged. The blades are marked with A or B, please install the blades so that they match with the A and B marked on the quadcopter. If the blades aren't installed properly the quadcopter will not fly correctly.

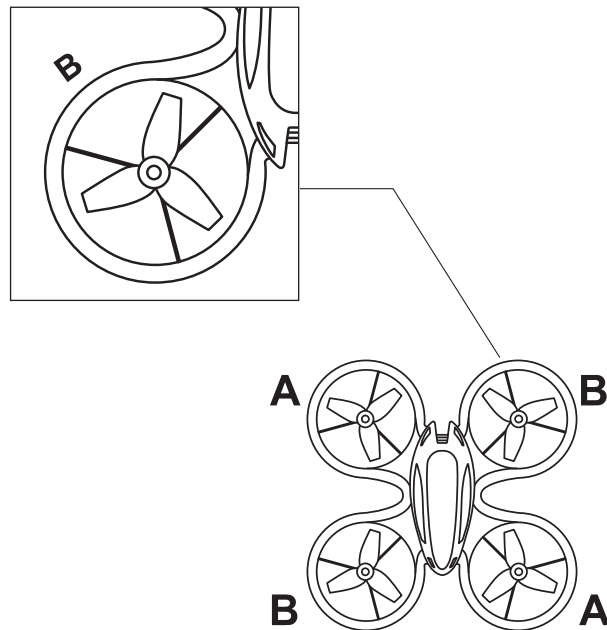

5. Flight Preparation

5.1 Pairing

Place the fully charged battery into the quadcopter. Turn both the quadcopter and the remote control ON, the indicator light on the remote will then start to flash. Place the quadcopter on flat ground far away from people, animals, objects and power lines.

To pair the quadcopter and remote, push the left joystick (throttle) to the highest position (the remote will beep) then pull the joystick down to lowest position (the remote will beep again). The indicator light on the remote will then change to hold a solid light.

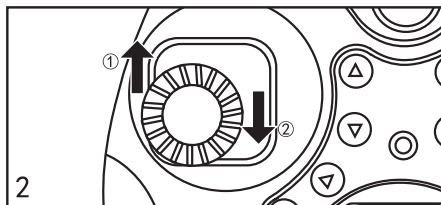
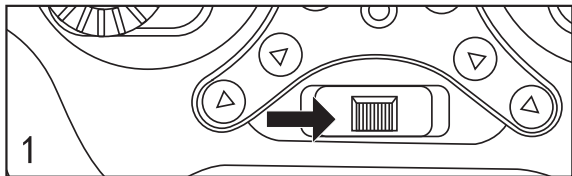
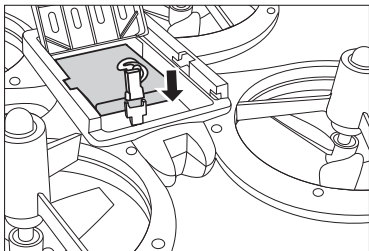

5.2 Quadcopter Operation



Please pay close attention while using this product, misuse could cause damage to the product or harm to the user and others.

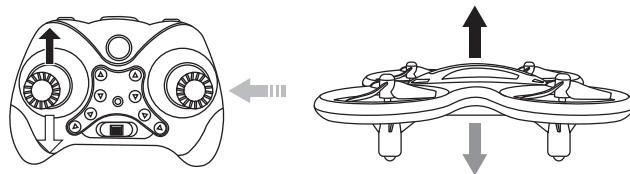

Push the left joystick up/down to ascend and descend the quadcopter.

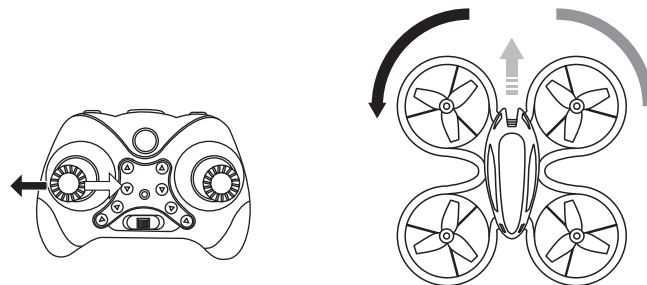

Push the left joystick right/left to turn the quadcopter left and right.

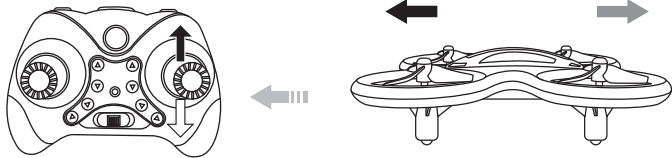

Push the right joystick up/down to move the quadcopter forwards and backwards.

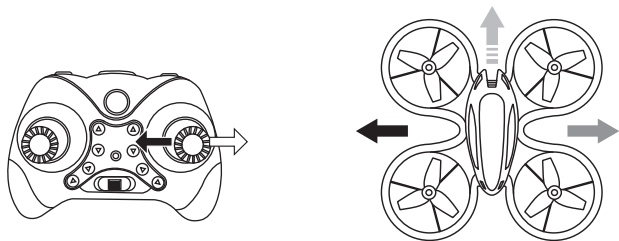

Push the right joystick left/right to move the quadcopter left and right.

5.3 Fine-Tuning

If the quadcopter starts to deviate forwards/backwards, left/right you can use the trimmer buttons on the remote control (see diagram on page 3) to fine-tune and stabilize the quadcopter.

- If the quadcopter deviates forwards, press the backwards trimmer to balance the quadcopter.
- If the quadcopter deviates backwards, press the forwards trimmer to balance the quadcopter.
- If the quadcopter deviates to the left, press the right trimmer to balance the quadcopter.
- If the quadcopter deviates to the right, press the left trimmer to balance the quadcopter.

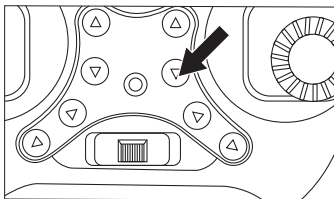

6. Speed Setting

The quadcopter has three different speed settings.

Press the speed setting button once to put the quadcopter into the slowest speed setting (30%), the remote will beep once to indicate it is in the slowest speed setting.

Press the button for a second time to put the quadcopter into the middle speed setting (60%), the remote will then beep twice.

Press the button for a third time to put the quadcopter into the fastest speed setting (100%), the remote will then beep three times. Only use this setting once you are comfortable with the basic operation of the quadcopter, to avoid losing control of the quadcopter.

7. Flips

The quadcopter can perform 360° stunts. For best performance, please ensure the quadcopter is at a minimum height of two metres.

7.1 Left Flip

Press the flip button and push the right joystick to the left.

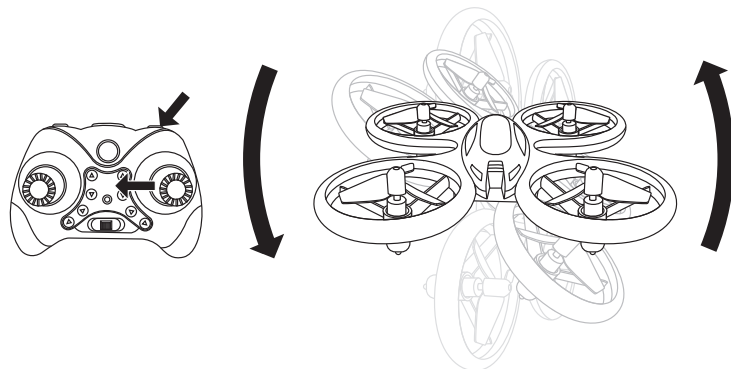

7.2 Right flip

Press the flip button and push the right joystick to the right.

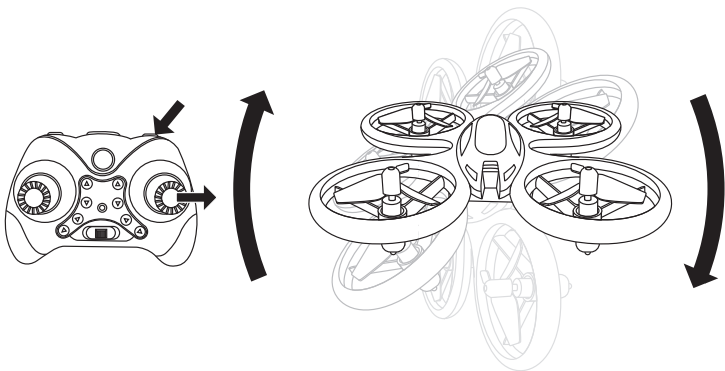

7.3 Front Flip

Press the flip button and push the right joystick up.

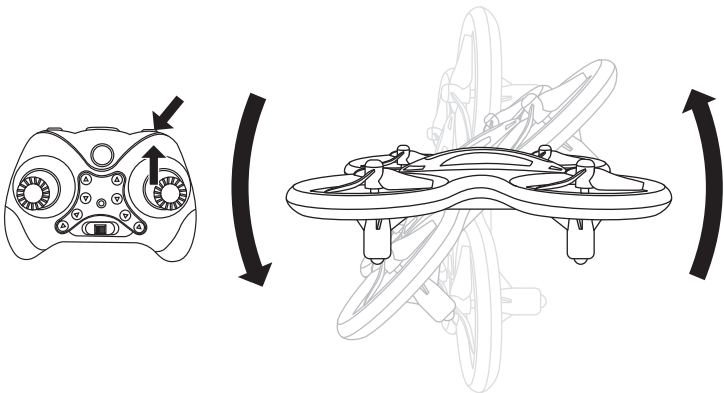

7.4 Backwards Flip

Press the flip button and then pull the right joystick down.

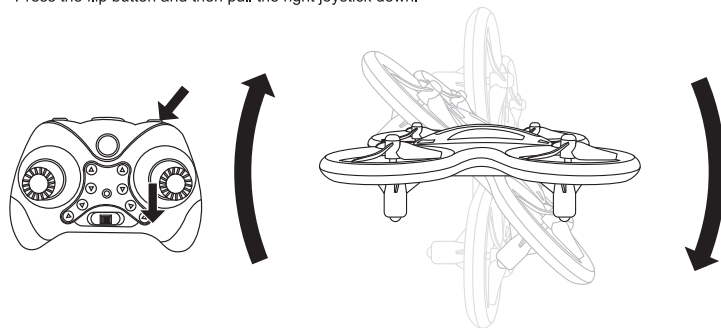

The remote control will beep continuously when it enters into flip mode.

9. Quadcopter Calibration

Note: The quadcopter will have been calibrated already, you should only need to re-calibrate if the quadcopter becomes un-calibrated e.g. after a collision.

To calibrate the quadcopter, push the left joystick to the bottom left corner while simultaneously pushing the right joystick to the bottom right corner. The quadcopter indicator lights will start to flash to show successful calibration.

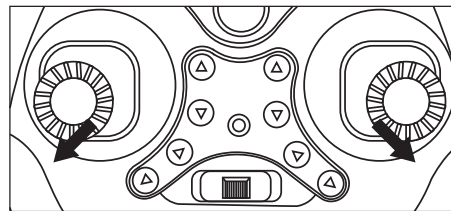

10. Troubleshooting

Problem	Reason	Solution
The quadcopter did not respond	<ol style="list-style-type: none"> 1. Signal matching failed. 2. Quadcopter or controller low voltage. 	<ol style="list-style-type: none"> 1. Re- pair again. 2. Replace the remote control batteries or recharge the quadcopter.
Failed flips	<ol style="list-style-type: none"> 1. Improper operation. 2. Quadcopter LED flashes. 	<ol style="list-style-type: none"> 1. Review the section 'Flips' again. 2. Recharge the battery.
Unable to take off	<ol style="list-style-type: none"> 1. The blade is assembled wrong. 2. Blade impact deformation. 3. Quadcopter LED flashes. 	<ol style="list-style-type: none"> 1. Check instruction manual for installation of blades. 2. Replace the blades. 3. The low-voltage protection, re charge the quadcopter.
The quadcopter shakes	<ol style="list-style-type: none"> 1. Blade impact deformation. 2. Gyroscope deviation. 	<ol style="list-style-type: none"> 1. Replace the blades. 2. Review the calibration section again.
The quadcopter response delays or interrupts signal	<ol style="list-style-type: none"> 1. Remote control has low power. 	<ol style="list-style-type: none"> 1. Replace the remote control batteries.
The LED will flash when the quadcopter has low power	<ol style="list-style-type: none"> 1. The quadcopter has low-voltage protection. 	<ol style="list-style-type: none"> 1. Stop flying the quadcopter and recharge the battery.

11. Quadcopter Components

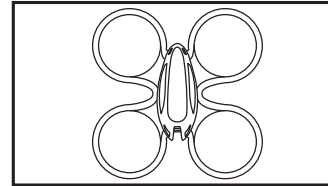

Upper Body Cover

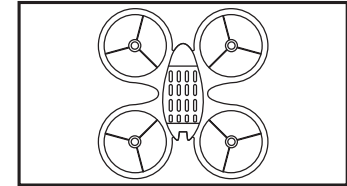

Bottom Body Cover

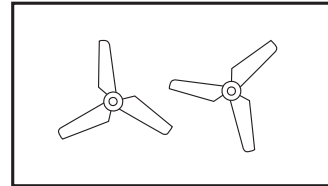

Rotary Blades

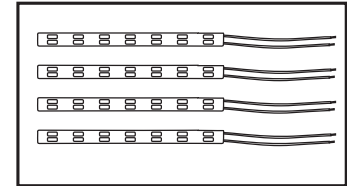

Navigation Lights (green/blue colour)

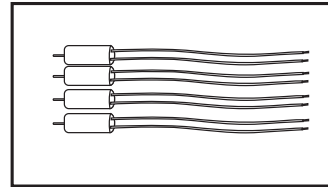

Main Motor A/B

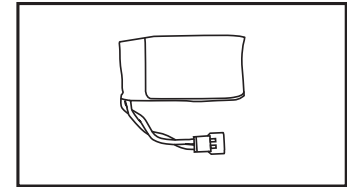

Battery

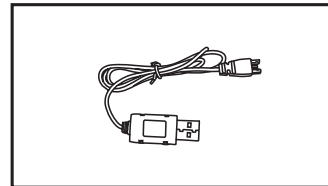

USB Charger

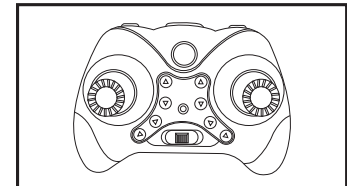

Remote Control

Battery Advice:

- The quadcopter contains a Lithium Polymer Battery which is built into the quadcopter. Do not disassemble the quadcopter as this may result in permanent damage or hazardous operation.
- DO NOT modify this product in any way.
- DO NOT launch at people or animals.
- DO NOT use near overhead cables, vents, fans or any other obstacles.
- Keep propeller away from eyes, face, hands, hair and loose clothing.
- Make sure people around you are aware you are using the quadcopter.
- If the quadcopter gets stuck in high places, ask an adult to retrieve it for you.
DO NOT attempt to retrieve it yourself.
- Only use the charger provided to charge the quadcopter.
- The charging process should only be completed by adults.

ADULT SUPERVISION IS RECOMMENDED AT ALL TIMES!

Note:

The battery will become warm during use, before charging the battery please allow the battery to cool down completely before removing from the quadcopter and before charging.

Important Battery Information:

- Requires 3 x AAA 1.5V (not included) for the controller.
- Batteries should only be replaced by an adult.
- Do not mix old and new batteries.
- Do not mix alkaline, standard (carbon-zinc) or rechargeable (nickel-cadmium) batteries.
- Do not re-charge non-rechargeable batteries.
- Rechargeable batteries are only to be charged under adult supervision.
- Rechargeable batteries are to be removed from the product before being charged.
- Ensure batteries are inserted with the correct polarity.
- Exhausted batteries should always be removed.
- The terminals should not be short circuited.
- Use a screwdriver to remove the screw from the battery cover. Replace battery cover and screw before use.

Hereby, Gift Universe Management Ltd, declares this product is in compliance with the essential requirements and other relevant provisions of Directive 2014/53/EU. A copy of the original Declaration of Conformity can be obtained at the following address:
Gift Universe, The Atrium, Curtis Road, Dorking Surrey RH4 1XA.

This product bears the selective sorting symbol for waste electrical and electronic equipment (WEEE). This means that this product must be handled pursuant to European Directive 2012/19/EU in order to be recycled or dismantled to minimize its impact on the environment. For further information, please contact your local or regional authorities. Electronic products not included in the selective sorting process are potentially dangerous for the environment and human health due to the presence of hazardous substances.

RED5

WWW.RED5.COM

Manufactured by RED5 RH4 1XA

Please retain the important information
on this packaging for future reference.

59092

MADE IN CHINA

Supplier item reference: 759

12/17

