

User Guide

PANTUM

WWW.PANTUM.COM

Pantum P2200/P2500 Series Pantum P2600 Series Monochrome Laser Printer



It is recommended to carefully read this Guide before using the printer

Preface

Welcome to the Pantum series products!

We heartily appreciate your using of Pantum series products!

To protect your vital interests, please carefully read the following statements.

Legal Notice

Trademark

Pantum and Pantum logos are registered trademarks of Zhuhai Pantum Electronics Co.,Ltd.

Microsoft[®], Windows[®], Windows Server[®] and Windows Vista[®] are trademarks registered by Microsoft Corporation in the United States or other countries/regions.

Mopria[®], the Mopria[®] Logo and the Mopeia[®] Alliance logo are registered trademarks and service marks of Mopria Alliance, Inc. in the United States and other countries. Unauthorized use is strictly prohibited.

Wi-Fi[®] and Wi-Fi Protected Setup[™] are registered trademarks of the Wi-Fi Alliance.

The ownership to the names of the software in this User Guide belongs to their respective owned companies in accordance with corresponding license agreement, and they are referred for instructions only.

All other product and brand names herein may be the registered trademarks, trademarks or service marks of their respective owners, and they are referred for instructions only.

Copyright

The copyright of this User Guide is owned by Zhuhai Pantum Electronics Co.,Ltd.

It is prohibited to copy, translate, modify and transmit this User Guide by any means or forms without the prior written consent of Zhuhai Pantum Electronics Co.,Ltd.

Disclaimer

Version: V1.4

For a better user experience, Zhuhai Pantum Electronics Co.,Ltd. reserves the right to make changes to the User Guide. The information contained herein is subject to change without notice.

Users are responsible for any damages arising from failing to follow this User Guide. Meanwhile, except the express warranty made in the product maintenance manual or service commitment, Zhuhai Pantum Electronics Co.,Ltd. does not make any express or implied warranty or guarantee to this User Guide (including composing or words).

Using this product to copy, print, scan certain documents or images or make other forms of operations may be prohibited by the local laws. If you are uncertain about the legality of using this product for certain documents or images, you should consult your legal advisor in advance.

Safety Precautions

Disconnect the power supply

The product should be placed close to or easily accessible to power sockets, so as to allow easy disconnection of power supply!

Laser Safety

The laser radiation is harmful to the human body. Since laser components are completely sealed in the printer, laser radiation will not leak. To avoid laser radiation, please do not randomly disassemble the printer!

The printer follows the provisions of Class 1 laser products under CFR standard. The printer has a Class III B laser diode, which has no laser radiation leakage among laser components.









The laser components shall comply with the requirements of: U.S. Code of Federal Regulations, 21 CFR 1040, IEC 60825-1

The following label is attached to the laser components inside the printer:

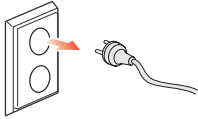

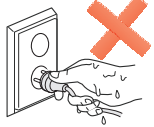
Safety Warning

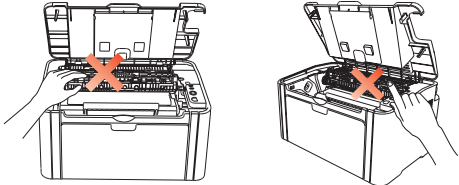
Please note the following safety warnings before using the printer:

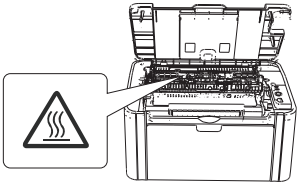
 Warning	
 There is high-voltage electrode inside the printer. Before cleaning the printer, make sure the power is turned off!	
 Plugging and unplugging the power cord plug with a wet hand can result in an electric shock.	
 The fuser unit is hot when and after printing. Touching the fuser unit (the shaded area as shown) may cause burns!	
 The fuser unit is attached with a high temperature warning label. Please do not remove or damage this label.	

Precautions

Precautions before Using the Printer:

1. Read and understand all instructions;
2. Familiarize yourself with the basic principles associated with operating electrical appliances;
3. Comply with all warnings and instructions marked on the equipment or specified in the manual supplied with the equipment;
4. If the operating instructions conflict with the safety information, please refer back to the safety information, as you may have misunderstood the operating instructions. If you cannot resolve the conflicts, please call the Customer Service Hotline or contact a service representative for help;
5. Before cleaning the equipment, remove the power cord from the AC power supply outlet. Do not use liquid or aerosol cleaners;
6. Please make sure that the equipment is put on a stable desktop surface to avoid serious damage caused by the falling of the equipment;
7. Do not put the equipment near a radiator, an air conditioner, or a ventilation pipe;
8. Do not place any articles on top of the power cord. Do not put the equipment in a place where its power cord will be stepped on by people;
9. Outlets and extension cords must not be overloaded. This may reduce performance and could result in fire or electric shock;
10. Do not allow pets to chew on the AC power cord or the computer interface cable;
11. Do not allow sharp objects piercing equipment slot, so as to avoid contact with the high-voltage device, which otherwise may result in fire or electric shock. Take care not to spill liquids onto the equipment;
12. Do not disassemble the equipment so as to avoid the risk of electric shock. Necessary repairs may only be carried out by professional maintenance personnel. Opening or removing the cover could result in an electric shock or other potential hazards. Incorrect disassembly and assembly could also result in an electric shock during future use;
13. If any one of the following occurs, disconnect the equipment from the computer and pull out the power cord from the AC wall socket and contact a qualified member of the service personnel for maintenance:
 - Liquid has been spilled into the equipment.
 - The equipment has been exposed to rain or water.
 - The equipment falls, or the cover is damaged.
 - Significant changes in the equipment's performance.
14. Only adjust the control mentioned in the instructions. Incorrect adjustment of other controls may result in damage and mean that professional maintenance personnel need to spend more time fixing it;
15. Do not use the equipment in a thunderstorm so as to avoid the risk of an electric shock. If possible, pull out the AC power cord during a thunderstorm;
16. If you continuously print multiple pages, the surface of the tray will become very hot. Take care not to touch this surface, and keep children away from this surface;
17. The signal wire of the device connected with the printer can not be connected to the outdoors;
18. Please ensure timely ventilation in case of a prolonged use or printing huge amounts of documents in a poorly ventilated room;
19. In standby status, the product will automatically enter into the power saving (sleep) mode if it does not receive any job order for a while (such as 1 minute); and it can realize zero power consumption only if it has not been connected with any external input power supply;
20. As the Class 1 equipment, the product must be connected to the power supply outlet with protective grounding line when using;
21. This product should be placed according to the shipping marks on the product package box during delivery;
22. This product is a kind of low-voltage equipment. When using this product below the specified voltage range, please refer to the product precautions or call Pantum Aftersales Service Centre, if the toner comes off the printed contents, or the equipment starts slowly;
23. This product is sold as a complete machine. The consumers can go to Pantum Aftersales Service Centre to purchase parts they need. If the product sold is inconsistent with the package list, please go to the specified Aftersales Service Centre to solve the problem;
24. Install this product in a place with the temperature between 10°C to 32.5°C, and the relative humidity between 20% to 80%;
25. For security and other reasons the printer may switch to intermittent printing after a certain amount of continuous printing.
26. This device complies with Industry Canada licence-exempt RSS standard(s). Operation is subject to the following two conditions:

-
- (1) this device may not cause interference, and
 - (2) this device must accept any interference, including interference that may cause undesired

27. IC Radiation Exposure Statement:

This equipment complies with Canada and FCC radiation exposure limits set forth for uncontrolled environments. This equipment should be installed and operated with a minimum distance of 20cm between the radiator and your body.

This transmitter must not be co-located or operating in conjunction with any other antenna or transmitter.

28. This equipment has been tested and found to comply with the limits for a Class B digital device, pursuant to Part 15 of the FCC Rules. These limits are designed to provide reasonable protection against harmful interference in a residential installation. This equipment generates, uses and can radiate radio frequency energy and, if not installed and used in accordance with the instructions, may cause harmful interference to radio communications. However, there is no guarantee that interference will not occur in a particular installation.

If this equipment does cause harmful interference to radio or television reception, which can be determined by turning the equipment off and on, the user is encouraged to try to correct the interference by one or more of the following measures:

- Reorient or relocate the receiving antenna.
 - Increase the separation between the equipment and receiver.
 - Connect the equipment into an outlet on a circuit different from that to which the receiver is connected.
 - Consult the dealer or an experienced radio/TV technician for help.
29. Changes or modifications not expressly approved by the party responsible for compliance could void the user's authority to operate the equipment.
30. The power consumption of the product is 0.92W in networked standby if all wired network ports are connected and all wireless network ports are activated;
31. Please keep this User Guide properly.

Regulatory Information



This symbol indicates that, at the end of your product's life, it must not be discarded as domestic waste. Instead, you should dispose of your used equipment at a designated collection point for the recycling of waste electrical and electronic equipment. Ref: EU Directive 2002/96/EC on Waste Electrical and Electronic Equipment (WEEE). Please contact your distributor / supplier for further information.



This product is suitable for indoor use only.



European Community (EC) directives conformity

This product complies with the protection requirements of EC directives 2014/30/EU and 2014/35/EU on the approximation and harmonization of the laws of the Member States relating to electromagnetic compatibility and safety of electrical equipment designed for use within certain voltage limits.

The manufacturer of this product is: Zhuhai Pantum Electronics Co.,Ltd., No.3883,Zhuhai Avenue,Zhuhai,Guangdong,China

A declaration of conformity to the requirements of the Directives is available upon request from the Authorized Representative.

This product satisfies the Class B limits of EN 55032 and safety requirements of EN 60950.



This printer is fully compliant with the ROHS Directive 2009/95/EC and the requirements of the revised Directive 2011/65/EU for managing toxic and hazardous substances.

Table of Contents

1. Before Using the Printer	1-2
1.1. Packing List	1-2
1.2. Components of the Printer	1-3
1.3. Laser Toner Cartridge	1-4
2. Paper and Print Media	2-2
2.1. Paper Specification	2-2
2.2. Special Paper	2-3
2.3. Loading Paper	2-4
2.3.1. Loading into the Automatic Feeder Tray	2-4
2.3.2. Loading into the Manual Feeder Tray	2-5
2.4. Nonprinting Area	2-7
2.5. Guidelines for Paper Use	2-7
3. Driver installation and uninstallation	3-2
3.1. How to install Windows printer driver.....	3-2
3.1.1. One-click Installation.....	3-2
3.1.2. Manual installation	3-16
3.1.3. Method of driver unistallation	3-22
3.2. Mac system driver installation.....	3-23
3.2.1. Driver installation	3-23
3.3. Add printer to Mac system	3-25
3.3.1. Add up the printer via USB	3-25
3.3.2. Add up the printer via wireline connection	3-25
3.3.3. Add up the printer via wireless connection.....	3-25
4. Wired Network Settings (For wired network printer models)	4-2
4.1. Set IP Address	4-2
4.2 Install the Printer to Network	4-3
4.3 Setting Network Products	4-4
4.3.1. View or Change Network Settings	4-4
4.3.2. Set or Change Web Server Login Password	4-4
4.3.3. Restore to Factory Settings	4-4
5. Wireless network setup (applicable to Wi-Fi models)	5-2
5.1. Basic structure mode	5-2
5.1.1. Wireless network setup tools	5-2
5.1.2. Wi-Fi Protected Setup (WPS) setup	5-7
5.1.3. How to disable the Wi-Fi network connected	5-7
5.2. Wi-Fi Direct mode	5-8
5.2.1. Preliminary preparations	5-8
5.2.2. Wi-Fi Direct connection	5-8
5.2.3. How to disable the Wi-Fi Direct	5-8
5.3. Wireless network setup FAQs	5-8
6. Pantum Mobile Print	6-2
6.1. What's Pantum Mobile Print	6-2
6.2. Download Pantum Mobile Print	6-2
6.3. Supported Mobile Operating System	6-2
6.4. How to use mobile devices for the mobile printing	6-2
6.4.1. For Android Devices	6-2
7. Print	7-2
7.1. Print Function	7-2
7.2. Opening Help Document	7-3
7.3. Manual Duplex	7-4
7.4. Cancel Print Job	7-7

8. Control Panel	8-2
8.1. Control Panel Overview	8-2
8.1.1. Functions of Buttons on the Control Panel	8-2
8.1.2. Function of LED Indicators on the Control Panel	8-3
9. Routine Maintenance	9-2
9.1. Cleaning the Printer	9-2
9.2. Maintenance of Laser Toner Cartridge	9-4
9.2.1. Use and Maintenance of Laser Toner Cartridge	9-4
9.2.2. Service Life of Laser Toner Cartridge	9-4
9.2.3. Replace Laser Toner Cartridge	9-5
10. Troubleshooting	10-2
10.1. Clearing Jammed Paper	10-2
10.1.1. Paper Jam in the Feed Port	10-3
10.1.2. Paper Jam inside the Printer	10-3
10.2. Common Troubleshooting	10-6
10.2.1. Common Trouble	10-6
10.2.2. Image Defects	10-8
11. Product Specification	11-2
11.1. P2200/P2500 Series Specification	11-2
11.1.1. Specification Overview	11-2
11.1.2. Printing Specification	11-3
11.2. P2600 Series Specification	11-4
11.2.1. Specification Overview	11-4
11.2.2. Printing Specification	11-5

Before Using the Printer

1







Chapter

1. Before Using the Printer	1-2
1.1. Packing List	1-2
1.2. Components of the Printer.....	1-3
1.3. Laser Toner Cartridge	1-4

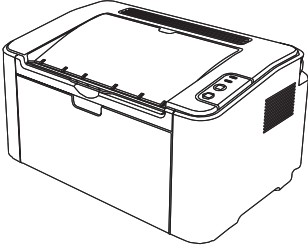
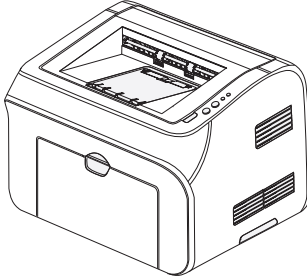
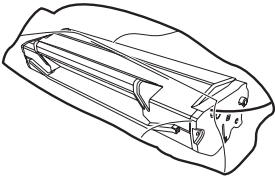
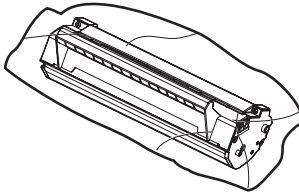
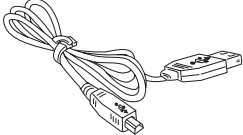
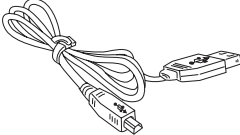
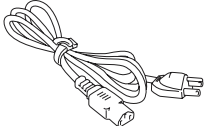
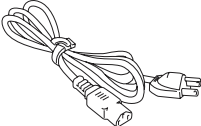
1. Before Using the Printer

1.1. Packing List

When you open the package, make sure that the following parts are included in the carton:

P2200/P2500 Series	P2600 Series	Name	Quantity
		Printer	1
		Laser Toner Cartridge	1
		USB Interface Cable	1
		Power Cord	1
		CD-ROM	1
		Quick Setup Guide	1
		Pantum Warranty	1



Note: • The Pantum Warranty may not be attached in some regions.

1.2. Components of the Printer

| Front View

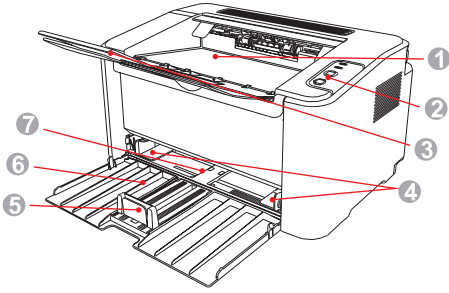
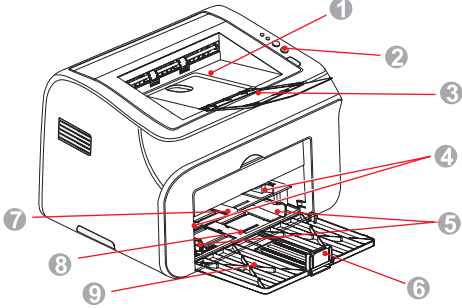
Serial No.	P2200/P2500 Series	P2600 Series
		
1	Output Bin	Output Bin
2	Control Panel	Control Panel
3	Output Tray	Output Tray
4	Automatic Feed Guide	Manual Feed Guide
5	Paper Stop	Automatic Feed Guide
6	Feeder Tray	Paper Stop
7	Automatic Feeder Tray	Manual Feeder Tray
8		Automatic Feeder Tray
9		Feeder Tray

| Rear View

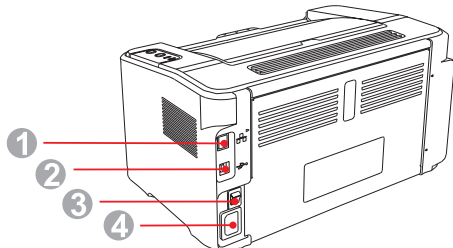
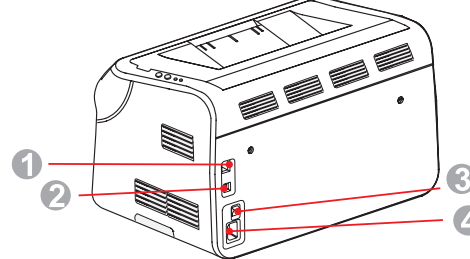

Note: • The rear view of the printer may vary depending on the models and functions.

Serial No.	P2200/P2500 Series	P2600 Series
		
1	Network Interface	Network Interface
2	USB Interface	USB Interface
3	Power Switch	Power Switch
4	Power Interface	Power Interface

1.3. Laser Toner Cartridge

| Service Life of the Laser Toner Cartridge

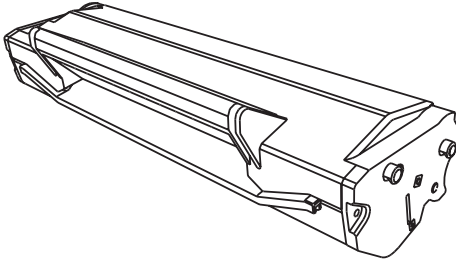
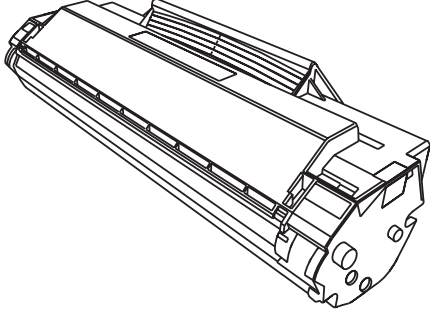
Series Name	P2200/P2500 Series	P2600 Series
Diagram		
Type	Average Print Volume	
Laser Toner Cartridge with Standard Capacity	About 1600 Pages (The above data is based on ISO/IEC 19752 standard)	About 1500 Pages (The above data is based on ISO/IEC 19752 standard)
Laser Toner Cartridge with High Capacity	N/A	About 2300 Pages (The above data is based on ISO/IEC 19752 standard)



- Note:**
- The model is subject to increase without notice.
 - Consumables capacity may vary depending on the types used.
 - The Company does not recommend using consumables other than that of the original Pantum consumables.
 - Any damages caused by using non-Pantum original consumables are not covered by the Warranty.

Paper and Print Media

2

Chapter

2. Paper and Print Media.....	2-2
2.1. Paper Specification.....	2-2
2.2. Special Paper	2-3
2.3. Loading Paper	2-4
2.3.1. Loading into the Automatic Feeder Tray	2-4
2.3.2. Loading into the Manual Feeder Tray	2-5
2.4. Nonprinting Area	2-7
2.5. Guidelines for Paper Use.....	2-7

2. Paper and Print Media

2.1. Paper Specification

P2200/P2500 Series P2600 Series	Automatic Feeder Tray	Media Type	Plain, thin, special paper (transparency, cardstock, label, envelope, thick, etc.).
		Media Size	A4, A5, JIS B5, ISO B5, A6, Letter, Legal, Executive, Folio, Oficio, Statement, Japanese Postcard, Monarch Env, DL Env, C5 Env, C6, Env, No.10 Env, ZL, Big 16K, Big 32K, 16K, 32K, B6, Yougata4, Postcard, Younaga3, Nagagata3, Yougata2, custom, etc.
		Media Weight	60~163g/m ²
		Maximum Capacity of the Tray	150 pages 80g/m ²
P2600 Series	Manual Feeder Tray	Media Type	Plain, thin, special paper (transparency, cardstock, label, envelope, thick, etc.).
		Media Weight	60~163g/m ²
		Maximum Capacity of the Tray	1 page



Note: • It is recommended to use the standard paper for the printer.

- Extensive use of special paper may affect the service life of the printer.
- The print media that does not meet the guidelines set out in this User Guide may result in poor print quality, increased paper jam and excessive wear of the printer.
- Properties such as weight, composition, texture and humidity are important factors affecting the printer performance and output quality.
- Please note the following matters when selecting the print media:
 1. Desired print effect: The print media selected should meet the requirement of the print tasks.
 2. Surface smoothness: The smoothness of the print media may affect the sharpness of the print outcome.
 3. Some print media may meet all the use guidelines contained herein, but they still can not bring satisfactory effect. This may be due to incorrect operation, inappropriate temperature and humidity, or other factors beyond the control of Pantum. Before purchasing large quantities of print media, make sure that the print media meets the specifications specified in this User Guide.
 4. Using print media that does not meet these specifications may cause damage to the printer.

2.2. Special Paper

This printer supports using the special paper for printing. Special paper includes: label, envelope, transparency, thick, cardstock, etc.



Note: • When using special paper or print media, be sure to select matched print type and size in the print settings so as to get the best print effect.

- When using special media to print, it is recommended to load one piece of paper at one time. For P2200/P2500 series, load one piece of special paper into the automatic feeder tray at one time. For P2600 series, load one piece of special paper into the manual feeder tray at one time.

| Please observe the following standards:

Types of Print Media	Correct Practices	Incorrect Practices
Label	Use labels with no exposed lining paper only. Labels shall be put flat when using. Use labels of full sheet only. There is no guarantee that all the labels in the market can meet corresponding requirements.	Use wrinkled, blistering or damaged labels.
Envelope	Envelopes should be loaded evenly.	Use wrinkled, nicked, stuck or damaged envelopes. Use envelopes with clips, snaps, Windows, or coated linings. Use envelopes with self-adhesive stickers or other synthetic materials.
Transparency	Use only transparencies approved for use in laser printers.	Use transparent print media that is not suitable for laser printers.
Thick, Cardstock	Use only heavy paper that is approved for use in laser printers and meets the weight specifications of this printer.	Use paper whose weight exceeds the recommended media specifications of this printer.

2.3. Loading Paper

2.3.1. Loading into the Automatic Feeder Tray

a) Open the feeder tray.

P2500 Series

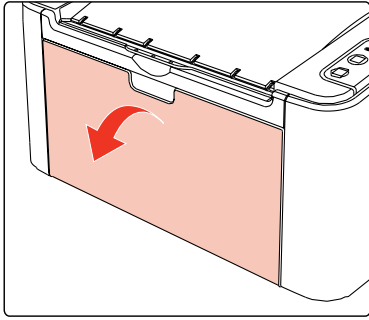

P2600 Series

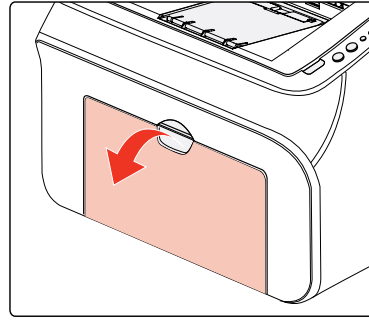

b) Slide the automatic feed guides to match both sides of the paper.

P2500 Series

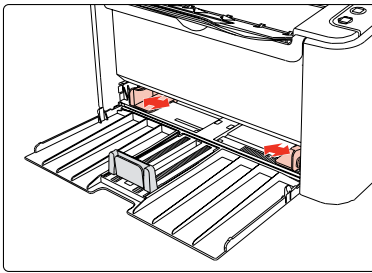

P2600 Series

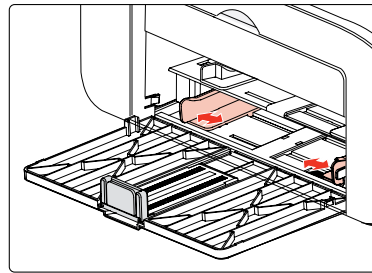

c) Raise the output tray to avoid the paper from slipping and falling.

P2500 Series

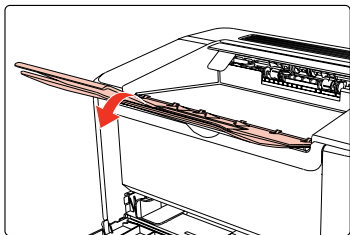

P2600 Series

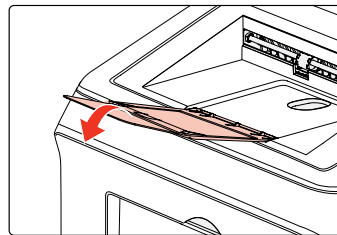

d) Load the paper into the automatic feeder tray with the print-side up.

P2200/P2500 Series

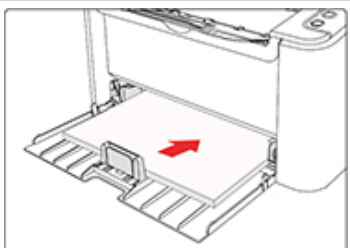

P2600 Series

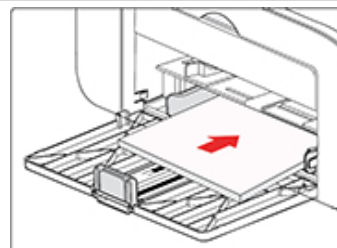



Note: • Before loading paper, please unfold the stacked paper to avoid a paper jam or feed error, and then load the paper into the tray print-side up.

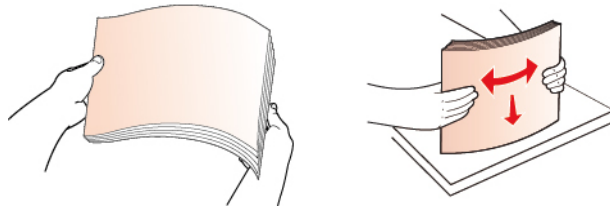

e) Adjust the paper stop to keep the paper in position. To ensure normal paper feeding, adjust the bottom paper stop ① into the slot to keep it from slipping out, and then adjust the blue stop ② to match the paper size.

P2200/P2500 Series

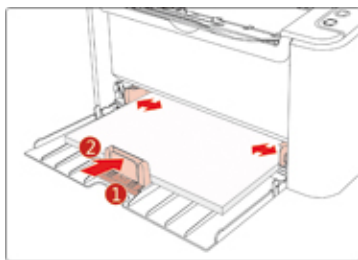

P2600 Series

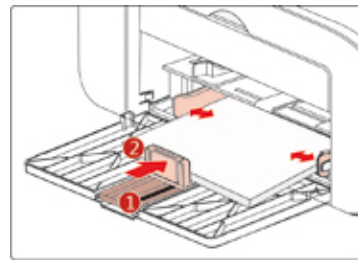

Note: • If the paper loaded into the automatic feeder tray at one time exceeds 150 pages, paper will jam or cannot be fed in.

- When using the printed paper, please make the side to be printed (the blank side) up.
- When printing on A5 paper, it is recommended that the paper is fed in landscape orientation, which can extend the service life of the laser toner cartridge.

2.3.2. Loading into the Manual Feeder Tray



Note: • Only P2600 series products support manual feeding.

a) Open the feeder tray.

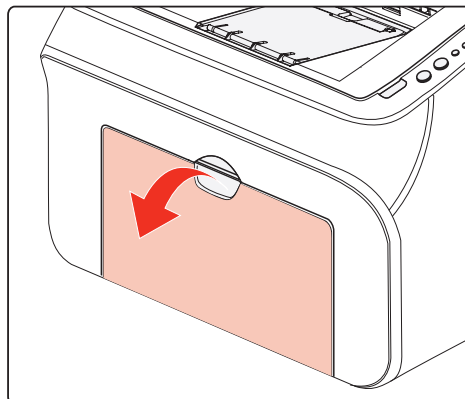

b) Slide the manual feed guides to match both sides of the paper.

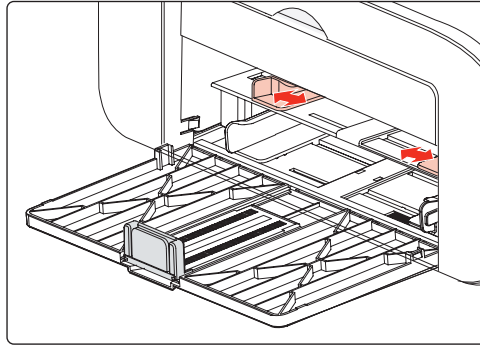

c) Raise the output tray to avoid the paper from slipping and falling.

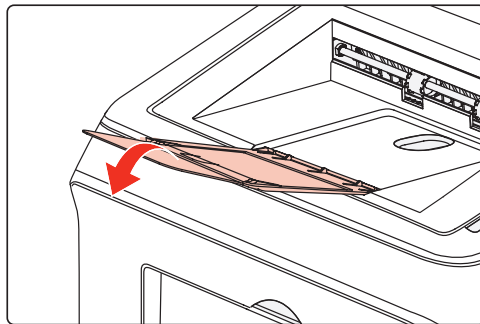

d) Put the print media like an envelope or transparency into the manual feeder tray with two hands until the front end of the envelope or transparency contacts the correction roller.

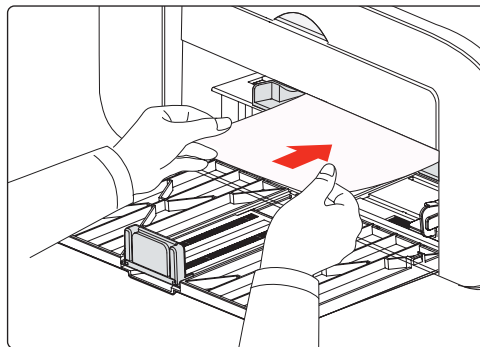

- Note:**
- When loading paper into the manual feeder tray, the printer will automatically enable the manual feed mode.
 - Load the paper into the manual feeder tray with the print-side up. When loading, the top of the paper first enters into the manual feeder tray.
 - Ensure that the paper, envelope or transparency is loaded straightly and in the correct position of the manual feeder tray. Otherwise, it will result in a skewed printout or a paper jam.

e) After the printed page is output from the printer, load another paper according to the above steps to continue printing.

Warning



After printing, please immediately remove the paper, envelopes and transparencies. Stacking paper or envelopes may cause a paper jam or the paper curling.

2.4. Nonprinting Area

The shaded section indicates the nonprinting area.

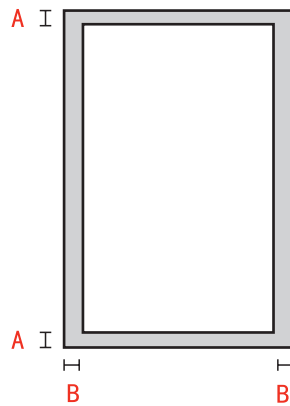

Usage	Paper Size	Top and Bottom Margins (A)	Left and Right Margins (B)
Printing	A4	5 mm (0.197 inch)	5 mm (0.197 inch)
	Letter	5 mm (0.197 inch)	5 mm (0.197 inch)

2.5. Guidelines for Paper Use

- Paper or manuscript with rough texture, concave and convex, oil stain and good smoothness has poor printing performance.
- Please make sure that there is no dust, fluff, etc. on the paper.
- Paper shall be put on a flat surface and stored under a cool and dry environment.

Driver installation and uninstallation

3

Chapter

3.Driver installation and uninstallation	3-2
3.1.Driver installation based on Windows system	3-2
3.1.1.Installation via USB connection	3-2
3.1.2.One-key wireless network installation	3-16
3.1.3.Installation via wired network connection.....	3-22
3.2.Driver installation based on Mac system	3-23
3.2.1.Driver installation.....	3-23
3.3.Add printer to Mac system	3-25
3.3.1.Add in USB connection mode	3-25
3.3.2.Addition in wired network connection mode.....	3-25
3.3.3.Add in wireless network connection mode.....	3-25

3. Driver installation and uninstallation

3.1. How to install Windows printer driver

Windows driver installation software provides two installing methods: one-click installation and manual installation. We recommend one-click installation, which can help to install driver automatically in a faster and more convenient way. If you have any difficulty in using one-click installation, please try manual installation.



Note: • Driver installation interface may differ because of different models and functions, so the schematic diagram is only for your reference.

3.1.1. One-click Installation

One-click installation provides three methods of installation: connect the printer via USB cable, connect the printer via wired network, and connect the printer via wireless network. You can choose one of them according to your habit.

3.1.1.1. Method I: Connect the printer via USB cable

1. Connect the printer to computer via USB cable, power the printer and computer on.
2. Place the attached installation CD in the computer CD-ROM:
 - Windows XP system: automatically run the installation procedure.
 - Windows 7/Vista/Server 2008 system: Pop up “Autoplay” interface, click “Autorun.exe” to run the installation procedure.
 - Windows 8 system: When the “DVD RW driver” window pops up from the right top corner of computer desktop, click anywhere in the pop-up window, then click “Autorun.exe” to run the installation procedure.
 - Windows 10 system: When the “DVD RW driver” window pops up from the right top corner of computer desktop, click anywhere in the window, then click “Autorun.exe” to run the installation procedure.



Note: • Some computers may be unable to auto play the CD because of system configuration. Please double click "Computer" icon, find "DVD RW driver", then double click "DVD RW driver" to run the installation procedure.

3. Click on the “I agree” button on the right bottom corner after reading the license agreement and enter into driver installation interface.
4. Click on the “One-click installation” button in Method I and enter into the installation process. The process may need some time, and the duration is related to your computer configuration, please wait patiently.

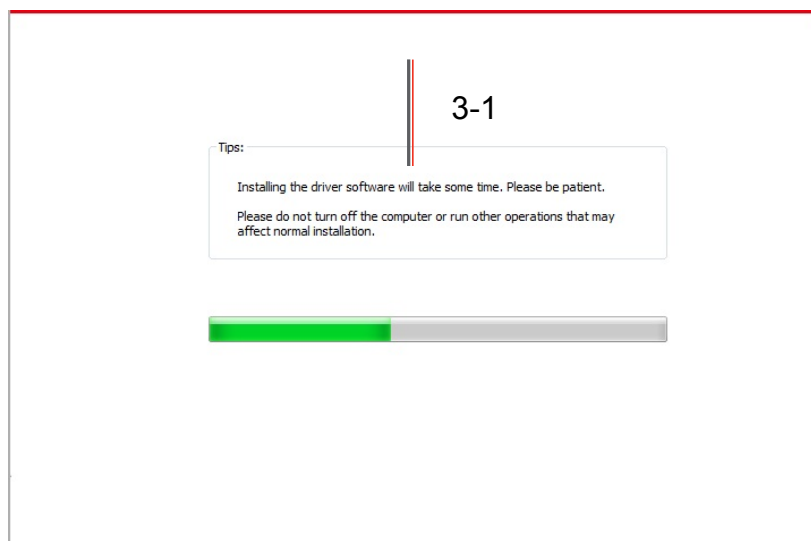
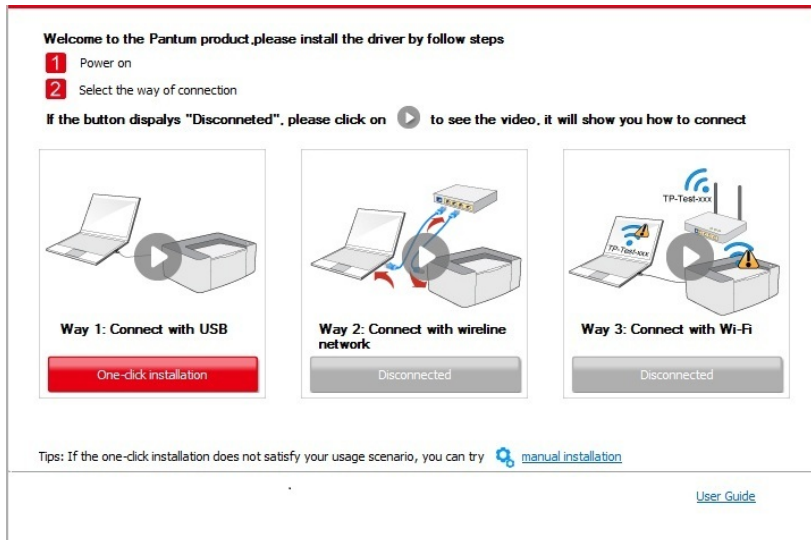

5. After the installation, click “Print & Test Page” button. If your printer prints the test page successfully, it means that you have installed the driver correctly.

3.1.1.2. Method II: Connect the printer via wired network

1. Turn the power of printer and computer on.
2. Connect the computer to wired network.
3. Connect network cable to the network interface of printer, to make sure the printer is connected to computer network (please refer to [Chapter 4](#) for network setup).
4. Place the attached installation CD in the computer CD-ROM:
 - Windows XP system: automatically run the installation procedure.
 - Windows 7/Vista/Server 2008 system: Pop up “Autoplay” interface, click “Autorun.exe” to run the installation procedure.
 - Windows 8 system: When the “DVD RW driver” window pops up from the right top corner of computer desktop, click anywhere in the pop-up window, then click “Autorun.exe” to run the installation procedure.

- Windows 10 system: When the “DVD RW driver” window pops up from the right top corner of computer desktop, click anywhere in the window, then click “Autorun.exe” to run the installation procedure.



Note: • Some computers may be unable to auto play the CD because of system configuration. Please double click "Computer" icon, find "DVD RW driver", then double click "DVD RW driver" to run the installation procedure.

5. Click on the “I agree” button on the right bottom corner after reading the license agreement and enter into driver installation interface.

6. Please click on the “One-click installation” button in Method II and install driver software.



Note : • You can put your mouse cursor in the “One-click installation” button to check the popup information in order to confirm if the current printer is the one you need to install through IP address before you click the button.

- You can check the printer IP address through “Network configuration page” (Please see [Chapter 8.1.1.3](#) for how to print).

- Click on the “One-click installation” button to enter installation process if your software has searched only one printer. The process may need some time, and the duration is related to your computer configuration. Please wait patiently.

Welcome to the Pantum product, please install the driver by follow steps

- 1 Power on
- 2 Select the way of connection

If the button displays "Disconnected", please click on to see the video, it will show you how to connect

 Way 1: Connect with USB Disconnected	 Way 2: Connect with wireline network One-click installation	 Way 3: Connect with Wi-Fi Disconnected
---	--	---

Tips: If the one-click installation does not satisfy your usage scenario, you can try [manual installation](#)

[User Guide](#)

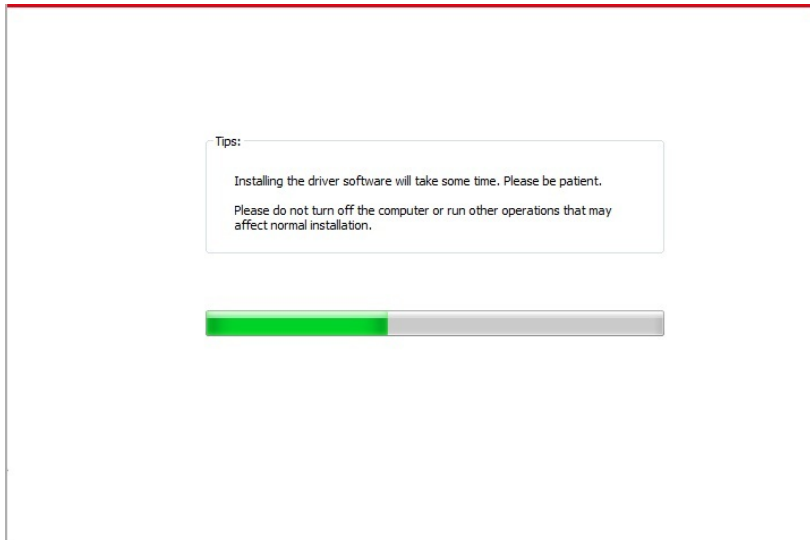

- If your software has searched several printers, click on the "One-click installation" button, and the printer list interface will pop up. Please select the printer that you need according to your printer wired network IP address or host ID.

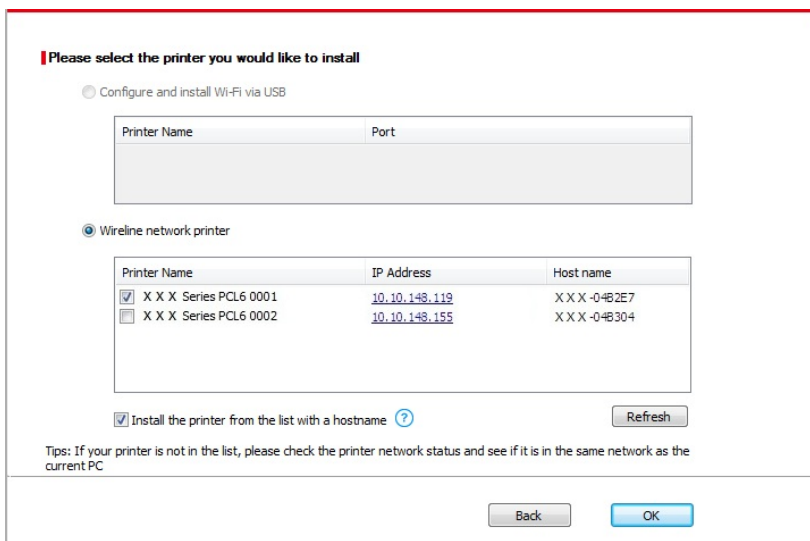
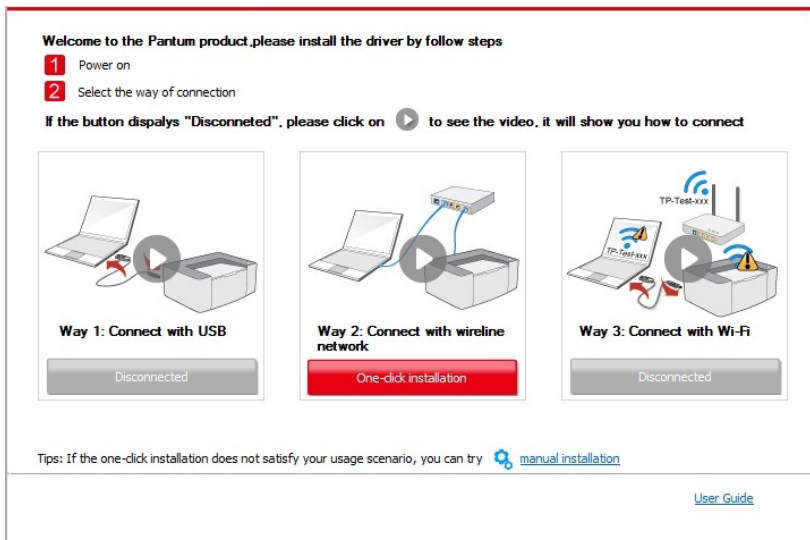



Note: • If the printer you need is not shown in the list, please click “Refresh” button to search again. If it is not found, please check if the printer and computer are in the same network. (Please see [Chapter 5.3](#) for how to check).

- When the printer IP address changes under printer driver installed with host ID , you can also directly print without re-installing the driver. If you need to install the printer driver with the host ID, please check the option “Install the printer in the list with host ID”.
-

7. After the installation, click “Print & Test Page” button. If your printer prints the test page successfully, it means that you have installed the driver correctly.

3.1.1.3. Method III: Connect the printer via wireless network

Please check if the printer is connected with wireless network when installing the printer driver software. If disconnected, please install it with reference to [Chapter 3.1.1.3.1](#). If connected, please install it with reference to [Chapter 3.1.1.3.2](#).



Note: • You can print "Network configuration page" to confirm printer network connection status to see if printer is connected with network (Please see [Chapter 8.1.1.3](#) or how to print).

3.1.1.3.1. The printer is not connected with wireless network

3.1.1.3.1.1. Configure wireless network via USB cable and install driver

Since some computers are not provided with wireless network function, this section is divided into "Connect computer to router via Wi-Fi" and "Connect computer to router via wired connection" to introduce installation process.

I. Connect computer to router via Wi-Fi

1. Computer is already connected to router via Wi-Fi.
2. Connect the printer to computer via USB cable, then power the printer on.
3. Place the attached installation CD in the computer CD-ROM:
 - Windows XP system: automatically run the installation procedure.
 - Windows 7/Vista/Server 2008 system: Pop up “Autoplay” interface, click “Autorun.exe” to run the installation procedure.
 - Windows 8 system: When the “DVD RW driver” window pops up from the right top corner of computer desktop, click anywhere in the pop-up window, then click “Autorun.exe” to run the installation procedure.
 - Windows 10 system: When the “DVD RW driver” window pops up from the right top corner of computer desktop, click anywhere in the window, then click “Autorun.exe” to run the installation procedure.



Note: • Some computers may be unable to auto play the CD because of system configuration. Please double click "Computer" icon, find "DVD RW driver", then double click "DVD RW driver" to run the installation procedure.

4. Click on the “I agree” button on the right bottom corner after reading the license agreement and enter into driver installation interface.

5. Click the “One-click installation” button in Method III to install driver software.



Note: • You can put your mouse cursor in the “One-click installation” button to check the popup information in order to confirm if the current printer is the one you need to install through IP address before you click the button.

• You can check the printer IP address through “Network configuration page” (Please see [Chapter 8.1.1.3](#) for how to print).

• Click “One-click installation” button if your software has searched only one printer, and enter into installation process to complete automatic network configuration and driver installation.

Welcome to the Pantum product, please install the driver by follow steps

- 1 Power on
- 2 Select the way of connection

If the button displays "Disconnected", please click on to see the video, it will show you how to connect

 Way 1: Connect with USB One-click installation	 Way 2: Connect with wireline network Disconnected	 Way 3: Connect with Wi-Fi One-click installation
--	---	--

Tips: If the one-click installation does not satisfy your usage scenario, you can try [manual installation](#)

[User Guide](#)

Tips:

Installing the driver software will take some time. Please be patient.
Please do not turn off the computer or run other operations that may affect normal installation.

- If your software has searched several printers, click “One-click intallation” button, and the printer list interface will pop up. Please select “Configure printer with Wi-Fi via USB and install” and select USB printer, click “Confirm” button and enter into installation process to complete automatic network configuration and driver installation.

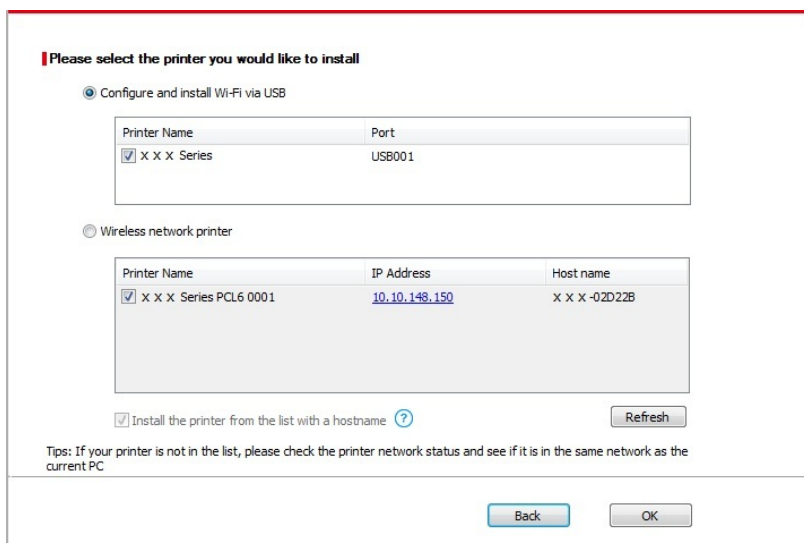
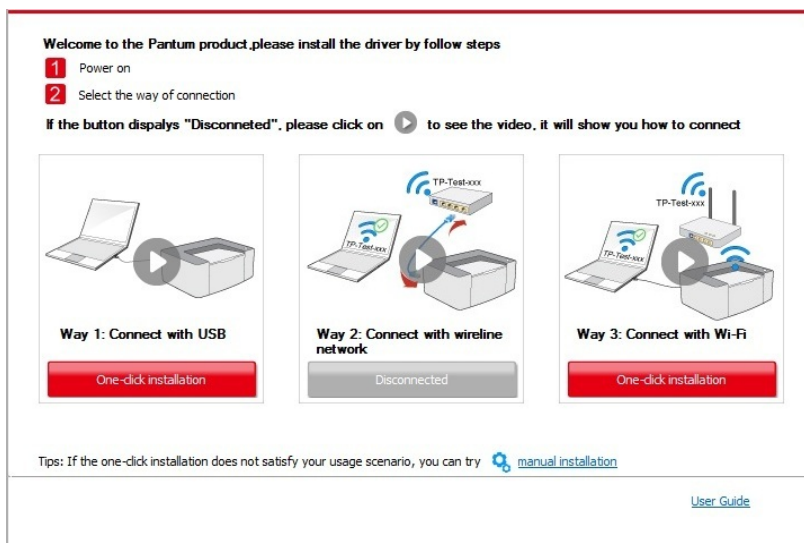

Note: • When the printer IP address changes under printer driver installed with host ID , you can also directly print without re-installing the driver. If you need to install the printer driver with the host ID, please check the option "Install the printer in the list with host ID".

6. After the installation, click “Print & Test Page” button. If your printer prints the test page successfully, it means that you have installed the driver correctly.

II. Connect computer to router via network cable

1. Connect computer to router via network cable.
2. Connect the printer to computer via USB cable, then power the printer on.
3. Place the attached installation CD in the computer CD-ROM:
 - Windows XP system: automatically run the installation procedure.
 - Windows 7/Vista/Server 2008 system: Pop up “Autoplay” interface, click “Autorun.exe” to run the installation procedure.
 - Windows 8 system: When the “DVD RW driver” window pops up from the right top corner of computer desktop, click anywhere in the pop-up window, then click “Autorun.exe” to run the installation procedure.
 - Windows 10 system: When the “DVD RW driver” window pops up from the right top corner of computer desktop, click anywhere in the window, then click “Autorun.exe” to run the installation procedure.



Note: Some computers may be unable to auto play the CD because of system configuration. Please double click "Computer" icon, find "DVD RW driver", then double click "DVD RW driver" to run the installation procedure.

4. Click on the “I agree” button on the right bottom corner after reading the license agreement and enter into driver installation interface.
5. Please click on the “One-click installation” button in Method III and install driver software.



Note: You can put your mouse cursor in the “One-click installation” button to check the popup information in order to confirm if the current printer is the one you need to install through IP address before you click the button.

- You can check the printer IP address through “Network configuration page” (Please see [Chapter 8.1.1.3](#) for how to print).

Welcome to the Pantum product, please install the driver by follow steps

- 1 Power on
- 2 Select the way of connection

If the button displays "Disconnected", please click on to see the video, it will show you how to connect

Way 1: Connect with USB
One-click installation

Way 2: Connect with wireline network
Disconnected

Way 3: Connect with Wi-Fi
One-click installation

Tips: If the one-click installation does not satisfy your usage scenario, you can try [manual installation](#)

[User Guide](#)

1. Please click on "Printing wireless network information page" to get the network name and encryption method. Please skip this step if you already know the network name and encryption method.

[Printing wireless network information page](#)

2. Please enter wireless network user name and password.

Network Name(SSID):

Encryption method:

Password:



Show password:

- Click on the "One-click installation" button if your software has only searched only one printer, and the wireless network configuration interface will pop up, input the SSID and password that you need, then click "Confirm" button, and enter into installation process. The process may need some time, and the duration is related to your computer configuration, please wait patiently.

Welcome to the Pantum product, please install the driver by follow steps

- 1 Power on
- 2 Select the way of connection

If the button displays "Disconnected", please click on  to see the video, it will show you how to connect

 Way 1: Connect with USB <input type="button" value="One-click installation"/>	 Way 2: Connect with wireline network <input type="button" value="Disconnected"/>	 Way 3: Connect with Wi-Fi <input type="button" value="One-click installation"/>
--	---	---

Tips: If the one-click installation does not satisfy your usage scenario, you can try [manual installation](#)

[User Guide](#)

- If your software has searched more than one printers, the printer list interface will pop up. You need to configure the current printer which is connected via USB cable to wireless network and install driver. Please select "Configure the print via USB and install" on the printer list interface and check the USB printer option. Click the "Confirm" button, and the wireless network configuration interface will pop up. Input the wireless SSID and password that you need, then click "Confirm" button, and enter into installation process. The process may need some time, and the duration is related to your computer configuration, please wait patiently.

Please select the printer you would like to install

Configure and install Wi-Fi via USB

Printer Name	Port
<input checked="" type="checkbox"/> X X X Series	USB001

Wireless network printer

Printer Name	IP Address	Host name
<input checked="" type="checkbox"/> X X X Series PCL6 0001	10.10.148.150	X X X -02D22B

Install the printer from the list with a hostname 

Tips: If your printer is not in the list, please check the printer network status and see if it is in the same network as the current PC

1. Please click on "Printing wireless network information page" to get the network name and encryption method. Please skip this step if you already know the network name and encryption method.

2. Please enter wireless network user name and password.

Network Name(SSID):

Encryption method:

Password:

Show password:



Note: When the printer IP address changes under printer driver installed with host ID , you can also directly print without re-installing the driver. If you need to install the printer driver with the host ID, please check the option "Install the printer in the list with host ID".

6. After the installation, click "Print & Test Page" button. If your printer prints the test page successfully, it means that you have installed the driver correctly.

3.1.1.3.1.2. Connect PC to printer via Wi-Fi hotspot and install the driver

Connect the computer to printer via Wi-Fi hotspot that applicable to wireless network without infrastructure mode. But it needs scenario of temporary use of printer via wireless network. You can connect the computer which equipped with wireless function to printer to realize printing function.

1. Turn the power of printer and computer on.

2. Connect computer to the Wi-Fi Direct network of the printer (please refer to [Chapter 5.2.2](#) for setup method).
3. Place the attached installation CD in the computer CD-ROM:
 - Windows XP system: automatically run the installation procedure.
 - Windows 7/Vista/Server 2008 system: Pop up “Autoplay” interface, click “Autorun.exe” to run the installation procedure.
 - Windows 8 system: When the “DVD RW driver” window pops up from the right top corner of computer desktop, click anywhere in the pop-up window, then click “Autorun.exe” to run the installation procedure.
 - Windows 10 system: When the “DVD RW driver” window pops up from the right top corner of computer desktop, click anywhere in the window, then click “Autorun.exe” to run the installation procedure.



Note: Some computers may be unable to auto play the CD because of system configuration. Please double click "Computer" icon, find "DVD RW driver", then double click "DVD RW driver" to run the installation procedure.

4. Click on the “I agree” button on the right bottom corner after reading the license agreement and enter into driver installation interface.
5. Click on the “One-click installation” button in Method III, and enter into installation process. The process may need some time, and the duration is related to your computer configuration, please wait patiently.

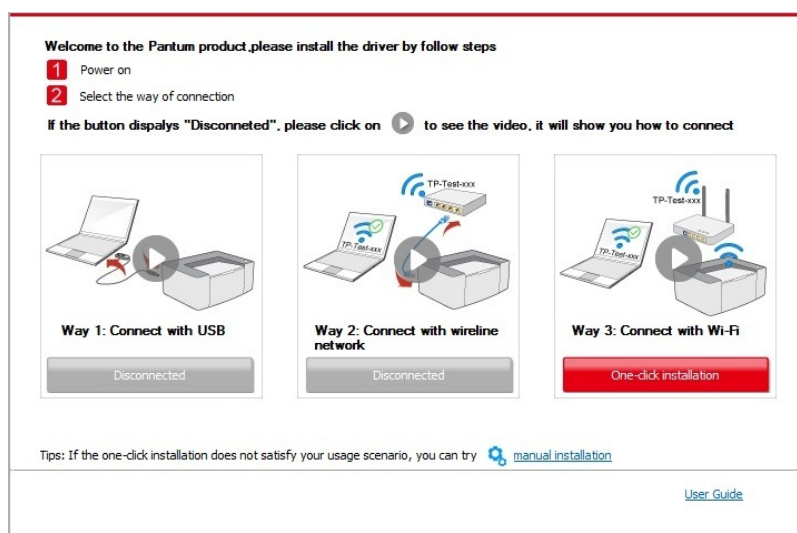

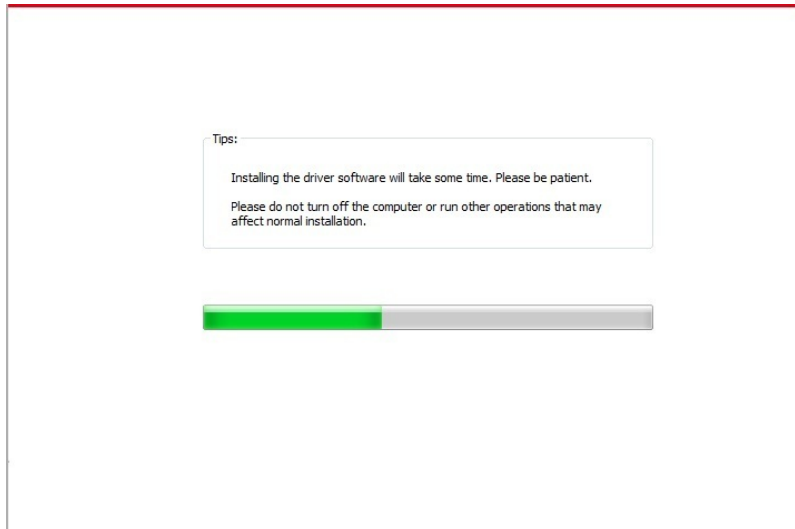

6. After the installation, click “Print & Test Page” button. If your printer prints the test page successfully, it means that you have installed the driver correctly.

3.1.1.3.2. The printer is already connected to wireless network

1. The printer is already connected to wireless network, you can print the “Network configuration page” to check.(see [Chapter 8.1.1.3](#) for how to print).
2. Connect the computer to printer network.
3. Place the attached installation CD in the computer CD-ROM:
 - Windows XP system: automatically run the installation procedure.
 - Windows 7/Vista/Server 2008 system: Pop up “Autoplay” interface, click “Autorun.exe” to run the installation procedure.
 - Windows 8 system: When the “ DVD RW driver” window pops up from the right top corner of computer desktop, click anywhere in the pop-up window, then click “Autorun.exe” to run the installation procedure.
 - Windows 10 system: When the “DVD RW driver” window pops up from the right top corner of computer desktop, click anywhere in the window, then click “Autorun.exe” to run the installation procedure.



Note:• Some computers may be unable to auto play the CD because of system configuration. Please double click "Computer" icon, find "DVD RW driver", then double click "DVD RW driver" to run the installation procedure.

4. Click on the “I agree” button on the right bottom corner after reading the license agreement and enter into driver installation interface.
5. Click the “One-click installation” button in Method III to install driver software.



Note:• You can put your mouse cursor in the “One-click installation” button to check the popup information in order to confirm if the current printer is the one you need to install through IP address before you click the button.

• You can check the printer IP address through “Network configuration page” (Please see [Chapter 8.1.1.3](#) for how to print)

• Click on the “One-click installation” button to enter installation process if your software has searched only one printer. The process may need some time, and the duration is related to your computer configuration. Please wait patiently.

Welcome to the Pantum product ,please install the driver by follow steps

- 1 Power on
- 2 Select the way of connection

If the button dispalys "Disconnected", please click on to see the video, it will show you how to connect

 Way 1: Connect with USB Disconnected	 Way 2: Connect with wireline network Disconnected	 Way 3: Connect with Wi-Fi One-click installation
--	---	---

Tips: If the one-click installation does not satisfy your usage scenario, you can try [manual installation](#)

[User Guide](#)

Tips:

Installing the driver software will take some time. Please be patient.

Please do not turn off the computer or run other operations that may affect normal installation.

- If the software has searched several printers, the printer list interface will pop up. Please select the printer you need according to your printer wired network IP address or host ID .

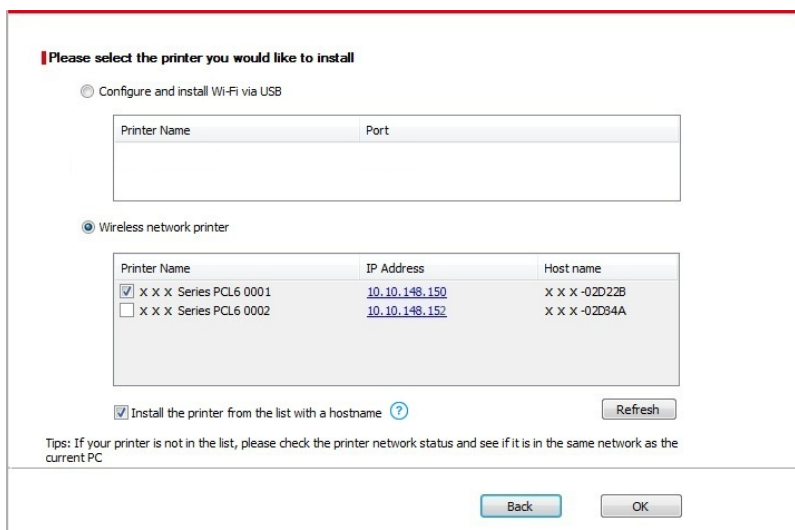
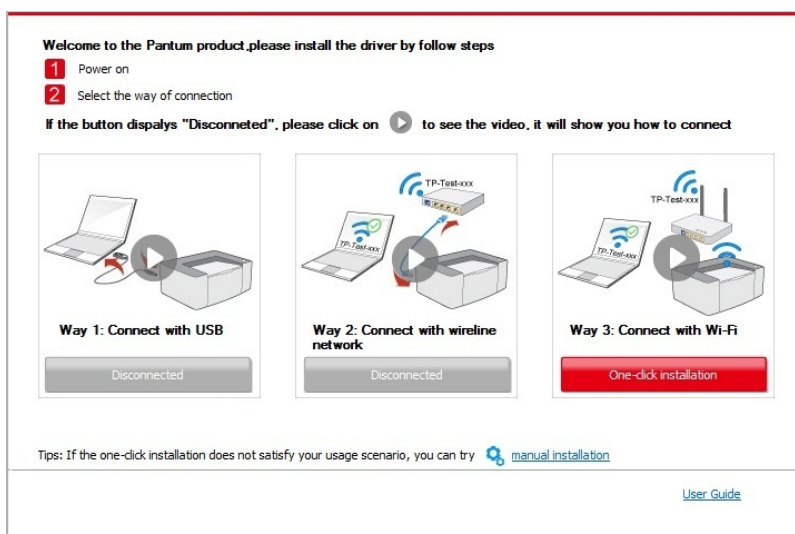

Note:• If the printer you need is not shown in the list, please click “Refresh” button to search again. If it is not found, please check if the printer and computer are in the same network. (Please see [Chapter 5.3](#) for how to check).

- When the printer IP address changes under printer driver installed with host ID , you can also directly print without re-installing the driver. If you need to install the printer driver with the host ID, please check the option “Install the printer in the list with host ID”.

6. After the installation, click “Print & Test Page” button. If your printer prints the test page successfully, it means that you have installed the driver correctly.

3.1.2. Manual installation

- Before installing the drive, you need to learn about printer model by printing printer information page out and check the product name (please refer to [Chapter 8.1.1.3](#) for printing methods).

3.1.2.1. Installation via USB connection

1. Connect the printer to computer via USB cable, power the printer and computer on.

2. Place the attached installation CD in the computer CD-ROM:

- Windows XP system: automatically run the installation procedure.
- Windows 7/Vista/Server 2008 system: Pop up “Autoplay” interface, click “Autorun.exe” to run the installation procedure.
- Windows 8 system: When the “DVD RW driver” window pops up from the right top corner of computer desktop, click anywhere in the pop-up window, then click “Autorun.exe” to run the installation procedure.
- Windows 10 system: When the “DVD RW driver” window pops up from the right top corner of computer desktop, click anywhere in the window, then click “Autorun.exe” to run the installation procedure.



Note: • Some computers may be unable to auto play the CD because of system configuration. Please double click “Computer” icon, find “DVD RW driver”, then double click “DVD RW driver” to run the installation procedure.

3. Click on the “I agree” button on the right bottom corner after reading the license agreement and enter into driver installation interface.

4. Click on the “Manual installation” at the bottom of driver installation interface, and enter into manual installation interface.

5. Please select installation language and printer model.

6. Select “Connect via USB” and click on “Install”.

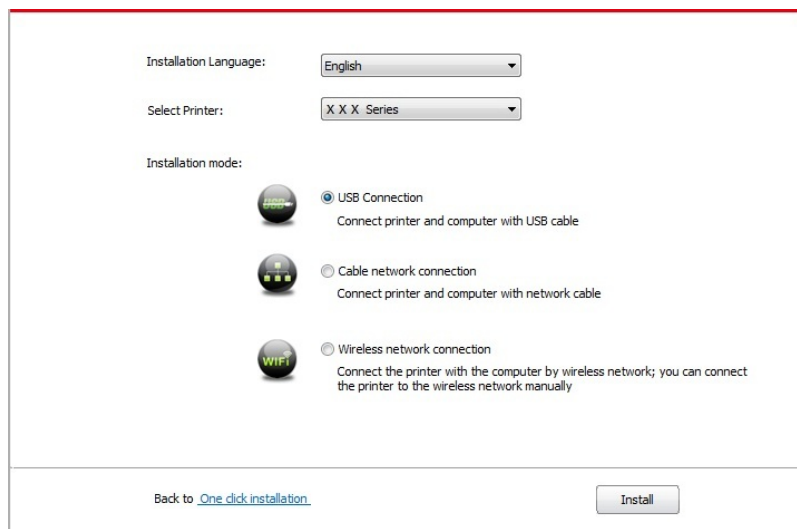

7. The software installs the driver automatically and the installation process may need some time. The duration is related to your computer configuration, please wait patiently.

8. After the installation, click “Print & Test Page” button. If your printer prints the test page successfully, it means that you have installed the driver correctly.

3.1.2.2. Installation via wired network connection

1. Turn the power of printer and computer on.
2. Connect the computer to wired network.
3. Connect network cable to the network interface of printer, to make sure the printer is connected to computer network (please refer to [Chapter 4](#) for network setup).
4. Place the attached installation CD in the computer CD-ROM:
 - Windows XP system: automatically run the installation procedure.
 - Windows 7/Vista/Server 2008 system: Pop up “Autoplay” interface, click “Autorun.exe” to run the installation procedure.
 - Windows 8 system: When the “DVD RW driver” window pops up from the right top corner of computer desktop, click anywhere in the pop-up window, then click “Autorun.exe” to run the installation procedure.
 - Windows 10 system: When the “DVD RW driver” window pops up from the right top corner of computer desktop, click anywhere in the window, then click “Autorun.exe” to run the installation procedure.



Note: Some computers may be unable to auto play the CD because of system configuration. Please double click “Computer” icon, find “DVD RW driver”, then double click “DVD RW driver” to run the installation procedure.

5. Click on the “I agree” button on the right bottom corner after reading the license agreement and enter into driver installation interface.
6. Click on the “Manual installation” at the bottom of driver installation interface, and enter into manual installation interface.
7. Please select installation language and printer model.
8. Select “Wireline network connection” and click on “Install”.

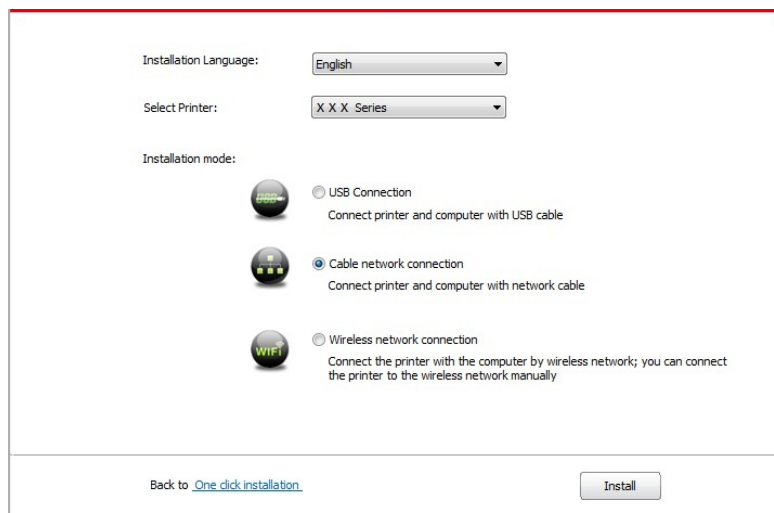

9. The installation software will search the printer automatically and the searching process may need some time.

10. After finishing searching, select the printer that needs to be connected and click “Next”.

Printer Name	IP Address	Host name
<input checked="" type="checkbox"/> X X X Series PCL6 0001	10.10.148.140	X X X -779888

Install the printer from the list with a hostname

Add the IP address or hostname manually



Note: • If the printer you need to connect is not in the list of printers searched, please click “Refresh” to search again.

- When the printer IP address changes under printer driver installed with host ID , you can also directly print without re-installing the driver. If you need to install the printer driver with the host ID, please check the option "Install the printer in the list with host ID".
- If IP address or host name is added manually, you need to know the IP address of the printer connected or host name. If they are not made clear, please print the “NetConf Pg” and view “IP Address” and “Host name” (Pleaserefer to [Chapter 8.1.1.3](#)).

8. The software installs the driver automatically and the installation process may need some time. The duration is related to your computer configuration, please wait patiently.

9. After the installation, click “Print & Test Page” button. If your printer prints the test page successfully, it means that you have installed the driver correctly.

3.1.2.3. Installation by wireless network connection mode

Wireless network connection type is divided into basic structure mode and Wi-Fi Direct mode (please refer to [Chapter 5](#) for details).

3.1.2.3.1. Installation in basic structure mode

1. Connect computer to access point (wireless router).
2. Connect the printer to computer via USB cable, then power the printer on.
3. Place the attached installation CD in the computer CD-ROM:
 - Windows XP system: automatically run the installation procedure.
 - Windows 7/Vista/Server 2008 system: Pop up "Autoplay" interface, click "Autorun.exe" to run the installation procedure.
 - Windows 8 system: When the "DVD RW driver" window pops up from the right top corner of computer desktop, click anywhere in the pop-up window, then click "Autorun.exe" to run the installation procedure.
 - Windows 10 system: When the "DVD RW driver" window pops up from the right top corner of computer desktop, click anywhere in the window, then click "Autorun.exe" to run the installation procedure.



Note: Some computers may be unable to auto play the CD because of system configuration. Please double click "Computer" icon, find "DVD RW driver", then double click "DVD RW driver" to run the installation procedure.

4. Click on the "I agree" button on the right bottom corner after reading the license agreement and enter into driver installation interface.
5. Click on the "Manual installation" at the bottom of driver installation interface, and enter into manual installation interface.
6. Please select installation language and printer model.
7. Select "Wireless network connection" and click on "Install".

The screenshot shows a software installation window with the following elements:

- Installation Language:** A dropdown menu currently set to "English".
- Select Printer:** A dropdown menu currently set to "X X X Series".
- Installation mode:** Three radio button options:
 - USB Connection**
Connect printer and computer with USB cable
 - Cable network connection**
Connect printer and computer with network cable
 - Wireless network connection**
Connect the printer with the computer by wireless network; you can connect the printer to the wireless network manually
- Bottom Bar:** A link "Back to [One click installation](#)" on the left and an "Install" button on the right.

8. 8. Select “Yes, I want to configure the printer’s wireless network” on the wireless setup window popped out, and operate according to the prompts to set up the printer to wireless network (please refer to [Chapter 5.1.1](#) for setup method).

The installation program will determine whether wireless network of the printer is to be configured based on your choice in this step;

- if you need to configure or change wireless network of the printer, please select “yes” after the printer connects USB;
- if not, please select “no”.

Yes, I want to configure the printer's wireless network.

No, the printer has been connected to wireless network.

Previous Next Exit

9. The installation software will search the printer automatically after wireless network is configured successfully. The search process may need some time.

10. Select the printer needs to be connected and click “Next”.

Detected Printer

Printer Name	IP Address	Host name
<input checked="" type="checkbox"/> X X X Series PCL6 0001	10.10.148.140	X X X -7796BB

Install the printer from the list with a hostname

Add the IP address or hostname manually

Previous Next Exit



Note: • If the printer you need to connect is not in the list of printers searched, please click “Refresh” to search again.

• When the printer IP address changes under printer driver installed with host ID , you can also directly print without re-installing the driver. If you need to install the printer driver with the host ID, please check the option "Install the printer in the list with host ID".

• If IP address or host name is added manually, you need to know the IP address of the printer connected or host name. If they are not made clear, please print the “NetConf Pg” and view “IP Address” and “Host name” (Please refer to [Chapter 8.1.1.3](#)).

11. The software installs the driver automatically and the installation process may need some time. The duration is related to your computer configuration, please wait patiently.

12. After the installation, click “Print & Test Page” button. If your printer prints the test page successfully, it means that you have installed the driver correctly.

3.1.2.3.2. Installation in Wi-Fi Direct mode

1. Turn the power of printer and computer on.
2. Computer is connected to printer’s Wi-Fi hotspot network (refer to [Chapter 5.2.2](#) for how to make configuration).
3. Place the attached installation CD in the computer CD-ROM:
 - Windows XP system: automatically run the installation procedure.
 - Windows 7/Vista/Server 2008 system: Pop up “Autoplay” interface, click “Autorun.exe” to run the installation procedure.
 - Windows 8 system: When the “DVD RW driver” window pops up from the right top corner of computer desktop, click anywhere in the pop-up window, then click “Autorun.exe” to run the installation procedure.
 - Windows 10 system: When the “DVD RW driver” window pops up from the right top corner of computer desktop, click anywhere in the window, then click “Autorun.exe” to run the installation procedure.



Note: Some computers may be unable to auto play the CD because of system configuration. Please double click “Computer” icon, find “DVD RW driver”, then double click “DVD RW driver” to run the installation procedure.

4. Click on the “I agree” button on the right bottom corner after reading the license agreement and enter into driver installation interface.
5. Click on the “Manual installation” at the bottom of driver installation interface, and enter into manual installation interface.
6. Please select installation language and printer model.
7. Select “Wireless network connection” and click on “Install”.

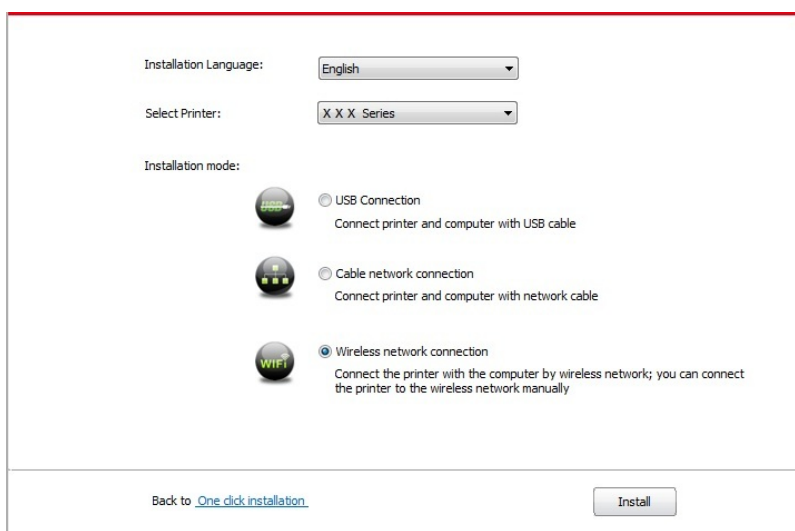

8. Select “No, the printer has been connected to wireless network” on the wireless setup window popping out, and then click “Next”.

The installation program will determine whether wireless network of the printer is to be configured based on your choice in this step;

- if you need to configure or change wireless network of the printer, please select “yes” after the printer connects USB;
- if not, please select “no”.

Yes, I want to configurate the printer's wireless network.

No, the printer has been connected to wireless network.

Previous Next Exit

9. The installation software will search the printer automatically and the searching process may need some time.

10. Select the printer needs to be connected and click “Next”.

Detected Printer

Printer Name	IP Address	Host name
<input checked="" type="checkbox"/> X X X Series PCL6 0001	10.10.148.140	X X X -779888

Install the printer from the list with a hostname Refresh

Add the IP address or hostname manually

Previous Next Exit



Note: • If the printer you need to connect is not in the list of printers searched, please click “Refresh” to search again.

• When the printer IP address changes under printer driver installed with host ID , you can also directly print without re-installing the driver. If you need to install the printer driver with the host ID, please check the option "Install the printer in the list with host ID".

• If IP address or host name is added manually, you need to know the IP address of the printer connected or host name. If they are not made clear, please print the “NetConf Pg” and view “IP Address” and “Host name” (Please refer to [Chapter 8.1.1.3](#)).

11. The software installs the driver automatically and the installation process may need some time. The duration is related to your computer configuration, please wait patiently.

12. After the installation, click "Print & Test Page" button. If your printer prints the test page successfully, it means that you have installed the driver correctly.

3.1.3. Method of driver unistallation

Windows 7 is taken as the example in the following operation. The information on your computer screen may differ because of multiple operating systems.

1. Click the Start menu of computer and then click All programs.

2. Click Pantum, and then Click Pantum XXX Series.

Pantum XXX Series where XXX represents product model.

3. Click uninstall to delete the driver according to instructions on uninstall window.

4. Restart computer after finishing unloading.

3.2. Mac system driver installation

- Driver installation under Mac system is divided into 2 steps, driver installation and adding a printer. If you are going to print in AirPrint mode, there is no need to install a driver and you just need to add a printer directly.
- When you are installing a driver with wired or wireless network, you may need to know the Bonjour name of printer. Please print the “Network setup page” to view it. (Please refer to [Chapter 8.1.1.3](#)).

3.2.1.Driver installation

Mac 10.11 is taken as the example in the following operation. The information on your computer screen may differ because of multiple operating systems.

1. Turn the power of printer and computer on.
2. Insert the CD accompanying with printer in the CD driver of your computer, and double click Pantum XXX Series installation package. (XXX in Pantum XXX Series represents product model.)



3. Click “Continue”.
4. Read licensing agreement and then click “Continue”.

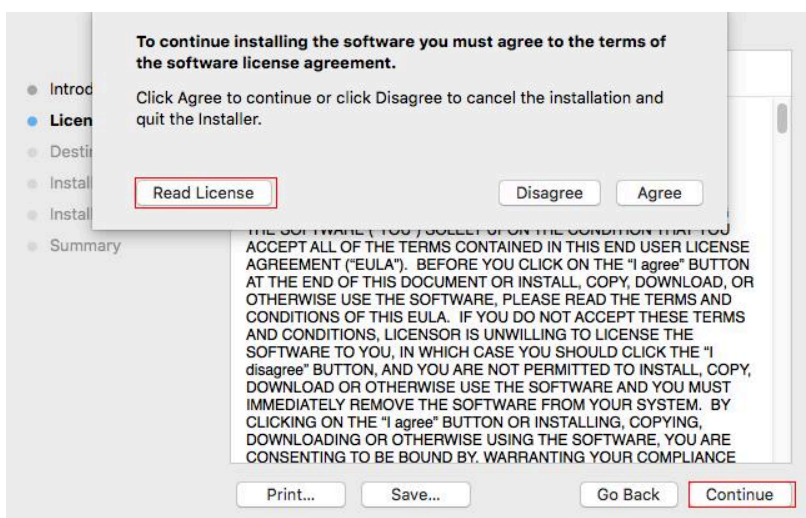

5. Click “Agree” on the prompt window popping out to accept the licensing agreement.
6. Click “Install”.
7. Input computer password and click “Install Software”.

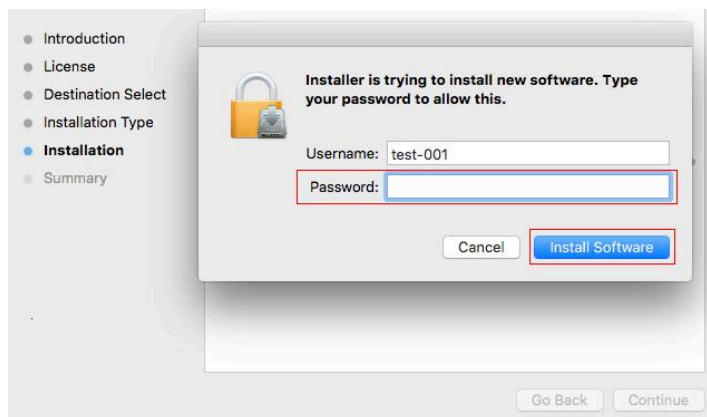

8. Click “Continue Installation” on the prompt window popping out.
9. The system will finish driver installation automatically .
 - If using a USB cable to connect a computer with a Wi-Fi model printer, a wireless network configuration prompt window will pop up during driver installation, as shown in following picture.

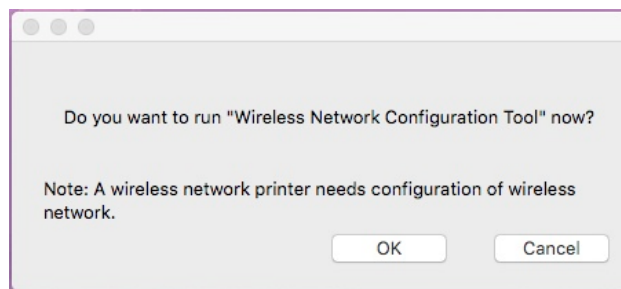

Note: • click “Yes”, you can configure printer’s wireless network via wireless network configuration tool (refer to [Chapter 5.1.1](#) for how to make configuration).When configuration is completed, unplug USB cable, and then on the pop-up “Add Printer” interface, you may add the network-connected printer(refer to [Chapter 3.3](#) for how to add printer).

- Click “No”, you can add a USB-connected printer on the pop-up “Add Printer” interface (refer to [Chapter 3.3](#) for how to add printer).
-

If using a USB cable to connect a computer with a non-Wi-Fi model printer, a “Add Printer” interface will pop up during the driver installation and you can add a printer here (refer to [Chapter 3.3](#) for how to add printer).

3.3.Add printer to Mac system

3.3.1.Add up the printer via USB

1. Connect the printer to computer with USB cable and then turn power on.
2. Enter the “System Preferences” – “Printers & Scanners” of computer.
3. Click  button to select “Add Printer or Scanner”.
4. Select printer and then select the corresponding printer mode from the “Use” menu popping out.
5. Click “Add”.

3.3.2.Add up the printer via wireline connection

1. Turn the power of printer and computer on.
2. Connect the computer to wired network.
3. Connect the network cable to the network interface of printer, and make sure the printer is connected to the computer network (Please refer to [Chapter 4](#) for network setup).
4. Enter the “System Preferences” – “Printers & Scanners” of computer.
5. Click  button to select “Add Printer or Scanner”.
6. Select printer and then select the corresponding printer mode from the “Use” menu popping out.
7. Click “Add”.

3.3.3. Add up the printer via wireless connection

1. Turn the power of printer and computer on.
2. Make sure the wireless network connection between computer and printer is set up.



Note: • In case of basic structure mode, connect wireless network printer to the access point (wireless router). Please refer to [Chapter 5.1](#) for connection method.
• In case of Wi-Fi Direct mode, connect wireless client to wireless network printer directly. Please refer to [Chapter 5.2](#) for connection methods.

3. Enter the “System Preferences” – “Printers & Scanners” of computer.
4. Click  button to select “Add Printer or Scanner”.
5. Select printer and then select the corresponding printer mode from the “Use” menu popping out.
6. Click “Add”.

Wired Network Settings (For wired network printer models)

4

Chapter

4. Wired Network Settings (For wired network printer models).....	4-2
4.1. Set IP Address	4-2
4.2. Install the Printer to Network.....	4-3
4.3. Setting Network Products	4-4
4.3.1. View or Change Network Settings	4-4
4.3.2. Set or Change Web Server Login Password	4-4
4.3.3. Restore to Factory Settings	4-4

4. Wired Network Settings (For wired network printer models)

You may need to set some network parameters on the printer. These parameters can be set from the embedded Web server.

4.1. Set IP Address

The IP address of the printer may be automatically obtained through DHCP function or set manually.

| Automatic Setting

DHCP automatic setting function is enabled by default on the printer.

1. Connect the printer to the network through a network cable and complete the startup preparation work.
2. The printer will automatically obtain the IP address assigned by the server. The IP address obtained automatically can be used after a few minutes.



Note: • If DHCP cannot automatically obtain the IP address, the printer will automatically use the default IP address: 169.254.xx.xx.

- Due to the features of DHCP, the IP address of the printer automatically assigned by the network may vary if the printer has not been used for a long time or the network access point changes, which could result in unsuccessful connection to the printer. It is recommended that the IP address automatically assigned by the network is bound to the Mac address of the printer while the DHCP function is enabled.
-

| Manual Setting

Type the IP address in the Web browser's address bar to open the embedded Web server.

1. Click Settings in the navigation bar to open the Settings page;
2. Select Network Settings - IPV4 Settings;
3. Set IP Address Assignment Mode (Manual), IP Address and Subnet Mask. Other items are optional;
4. Click Apply to save the settings.



Note: • You can use the embedded Web server to change the IP Address Assignment Mode into Automatic or Manual.

4.2. Install the Printer to Network

In this setting, the printer is directly connected to the network and can be set to allow all computers on the network to print directly on the printer.

1. Before starting the printer, first connect the network cable to the network port of the printer to establish direct connection to the network.
2. Start the printer and wait until the status indicator on the control panel displays Ready status, as shown below.

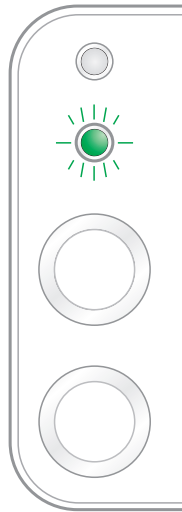

3. Insert the printer CD into the computer. If the software installer does not start, browse to the "setup.exe" file on the CD, and double-click to run the file.
4. Follow the operation instructions of the installer.
5. Continue to complete the installation.



Note:

- When the installer prompts you to select a printer, you can select the appropriate printer name from the Detected Printer;
- If the printer name does not appear in the Detected Printer, please click Refresh and search for printers on the network;
- If you know the IP address of the printer to be connected, you can select Specify an IP Address for Installation to enter the IP address for installation.

4.3. Setting Network Products

4.3.1. View or Change Network Settings

You can use the embedded Web server to view or change IP settings.

1. Long press the "Cancel/Continue" button on the control panel to print Demo information page, and view the IP address of the printer. Demo page can be printed by long pressing the button on the control panel (as shown in the figure below) in the idle status.
2. Type the IP address in the Web browser's address bar to access the embedded Web server.
3. Click Settings tab to obtain network information. Change the settings as needed.

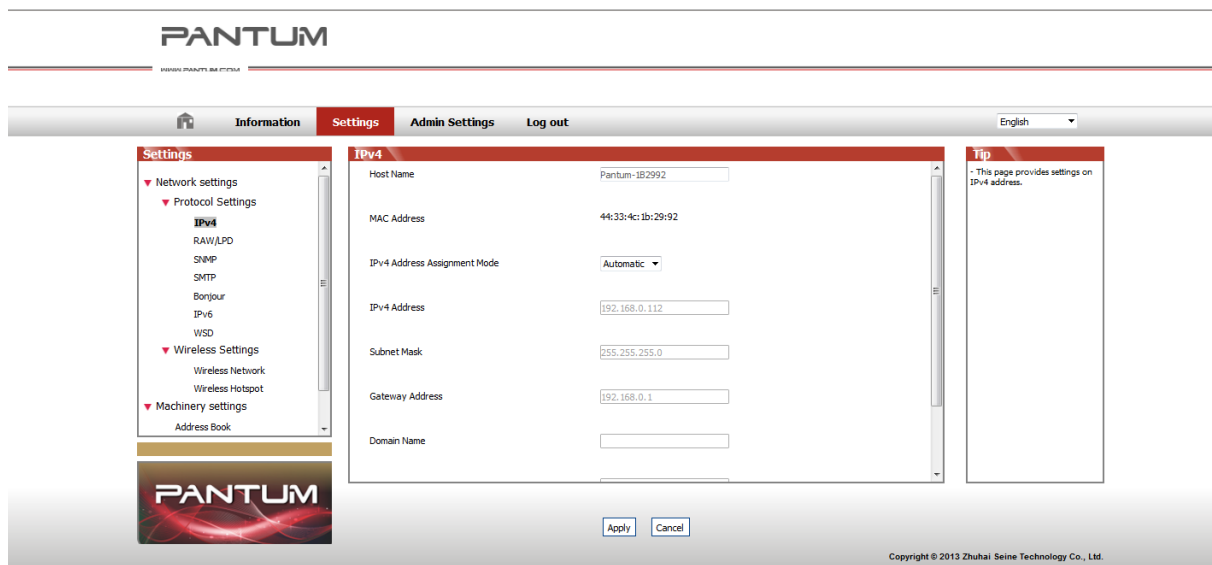

4.3.2. Set or Change Web Server Login Password

Use the embedded Web server to set a network password or change the existing password.



Note: • The default username is "admin", and the initial password is "000000".

1. To open the embedded Web server, please log in first.
2. Click Administrator Settings tab.
3. Type the new password in the Password box and Confirm Password box.
4. At the bottom of the window, click Apply button to save the settings.

4.3.3. Restore to Factory Settings

If you want to reset all parameter settings of the printer, you can restore to the factory settings by long pressing "Cancel/Continue" button when the printer is powered off to power on it and holding for 10 seconds until the printer enters Ready status to finish the resetting work.

Wireless network setup (applicable to Wi-Fi models)

5

Chapter

5. Wireless network setup (applicable to Wi-Fi models).....	5-2
5.1. Basic structure mode	5-2
5.1.1. Wireless network setup tools	5-2
5.1.2. Wi-Fi Protected Setup (WPS) setup.....	5-7
5.1.3. How to disable the Wi-Fi network connected.....	5-7
5.2. Wi-Fi hotspot mode.....	5-8
5.2.1. Preliminary preparations	5-8
5.2.2. Wi-Fi Hot Connection	5-8
5.2.3. Wi-Fi Hotspot Configuration	5-8
5.3. Wireless network setup FAQs.....	5-8

5. Wireless network setup (applicable to Wi-Fi models)

Depending on model, the printer with Wi-Fi printing function supports the two types of wireless network connection of both infrastructure connection mode and Soft-AP, while there is usually only one connection between computer and printer at a time. If you have problems during wireless network setup, please refer to [Chapter 5.3](#) Wireless Network Setup Frequently Asked Questions.



Basic structure mode: connecting to a wireless device via router

1. Access point (wireless router)
2. Wireless network printer
3. Computer connecting to access point via wireless network
4. Computer connecting to access point via network cable



Soft-AP

The wireless computer is directly connected to the wireless device.

5.1. Basic structure mode

You can connect a computer to your printer via access point (wireless router) as the medium. Access point (wireless router) connection is divided into wireless network setup and Wi-Fi Protected Setup (WPS).

Important: Before wireless network installation, you must learn about the service set identifier (SSID) and password of your access point in order to use them during wireless network setup. If they cannot be determined, please consult your network administrator or access point (wireless router) manufacturer.

5.1.1. Wireless network setup tools

If your computer has been installed with a driver and had been connected to wireless network, but the wireless network was changed, you can set it again with wireless network setup tools.

5.1.1.1. Preliminary preparations

1. Access point (wireless router).
2. A computer that has been connected to network.
3. A printer that has wireless network function.

5.1.1.2. Setup methods of wireless network setup tools

1. Take the wireless network setup tool in computer.

1) **Windows system:** Click the “Start menu” – “All programs” - “Pantum”- Product name – “Wireless network setup tool”.

2) **Mac system:** click “Go” - “Applications” - “Pantum” - “Utilities” - “Wireless Network Configuration Tool” on the computer Finder menu bar.

2. Use USB cable to connect and configure. Select “Yes, I have a USB cable that can be used for installation” in the following interface. Click “Next”.

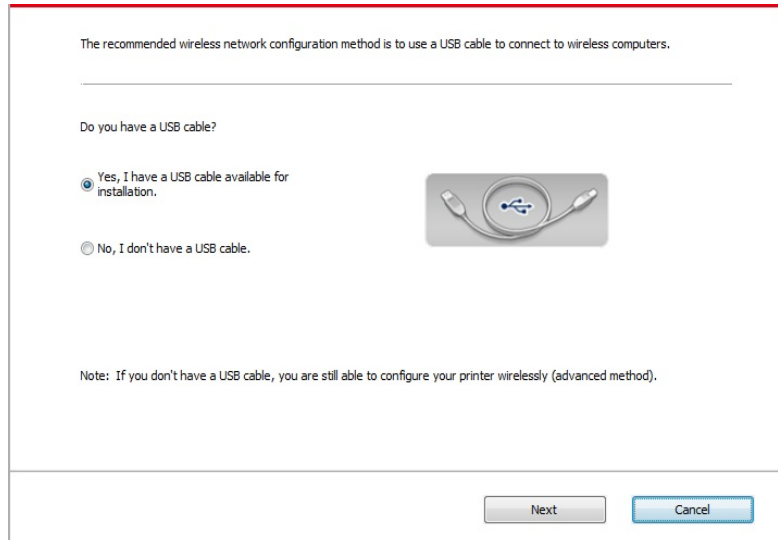

2.1 The computer has been connected to wireless network.

1) The currently wireless network currently connected to computer is selected as wireless network configuration tool by default. Complete configuration according to interface prompt.

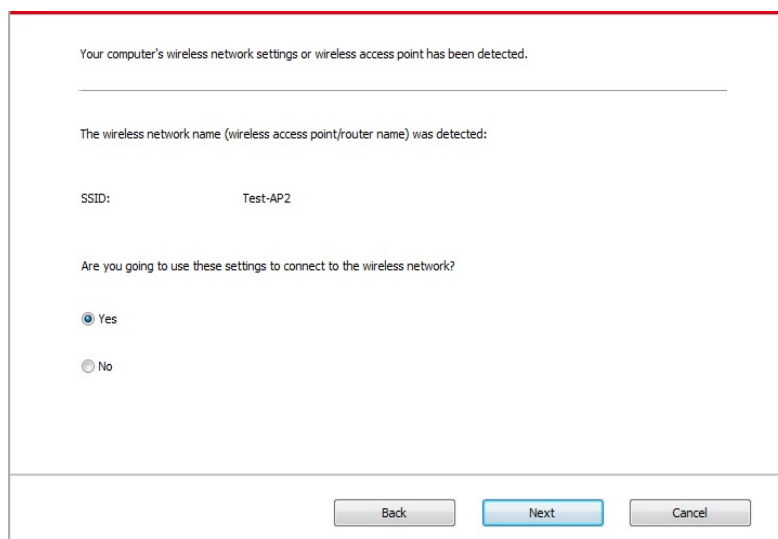



Note: • The SSID you selected should be consistent with the SSID of access point (wireless router) connected to your computer.

2) Please tick “No” to configure other wireless network needed to connect to. Complete configuration according to interface prompt.

Please select the corresponding network name (SSID) from the following list, or manually enter the SSID and password if necessary, and then click "Next" to configure.

Network Name	Encryption method	Signal Strength
Test-AP2	WPA/WPA2	100%
Test-AP3	WPA/WPA2	100%

Refresh

Network Name (SSID):
Test-AP3

Encryption method:
WPA/WPA2

Password:
 Show password

Back Next Cancel



Note: • At present, the printer supports 3 types of safe modes: none, WEP and WPA/WPA2.

- 1) None: There is no encryption method used.
 - 2) WEP: Send and receive data via security key by using WEP (Wired Equivalent Privacy). WEP key is applicable to 64-digit and 128-digit encrypted network and can contain numbers and letters at the same time.
 - 3) WPA/WPA2: it is the pre-shared key (PSK) of Wi-Fi protected access which connects wireless device and access point via TKIP or AES encryption (WPS-Personal). The working length of WPA/WPA2 is within the PSK of 8-63 characters.
 - The display password is not ticked by default; if it is ticked, all passwords input can be seen in clear text.
-

2.2 The computer is not connected to wireless network Input the SSID (case sensitive) and password of access point (wireless router) in the interface below. Complete configuration according to interface prompt.

1. Please click on "Print wireless network information page" to get the network name and encryption method. Please skip this step if you already know the network name and encryption method.

Printing wireless network information page

2. Please enter wireless network user name and password.

Network Name (SSID):

Encryption method:

None

Back Next Cancel



- Note:**
- If you do not know the SSID of access point (wireless router), please click "Print Wireless Network Information Page" to view the SSID of the needed access point (wireless router).
 - If the printer cannot be used normally after wireless network setup is finished, please install the drive again.

3. Use WPS connection .

Select "No, I don't have a USB cable" in the interface below and then click "Next".

The recommended wireless network configuration method is to use a USB cable to connect to wireless computers.

Do you have a USB cable?

Yes, I have a USB cable available for installation.

No, I don't have a USB cable.

Note: If you don't have a USB cable, you are still able to configure your printer wirelessly (advanced method).

Next Cancel

1) Use WPS method to perform steps below to start wireless network on printer. (Please refer to [Chapter 5.1.2](#) for detailed WPS configuration)

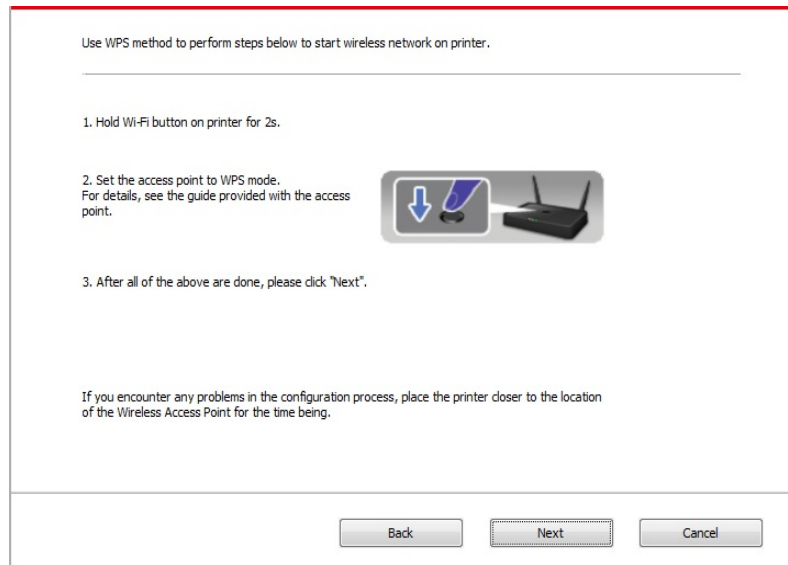

2) Judge if the printer is successfully connected according to the status of Wi-Fi indicator on printer. If configuration failed, please click “Previous” to configure again; if configuration succeeded, please click “Done” to complete configuration.

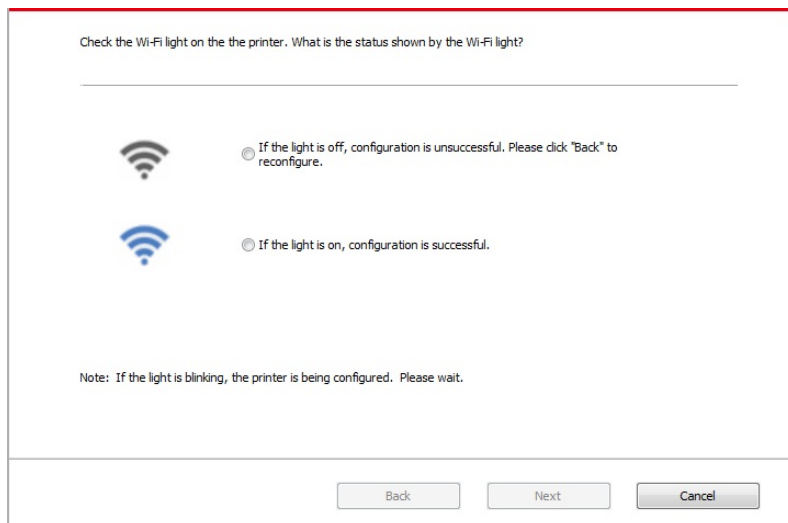

Note: • If the printer cannot be used normally after wireless network setup is finished, please install the drive again.

5.1.2.Wi-Fi Protected Setup (WPS) setup

If the access point (wireless router) supports Wi-Fi Protected Setup (WPS), the Wi-Fi key on the control panel of printer and WPS key on access point (wireless router) can be pressed in order to connect the printer to wireless network.

5.1.2.1.Preliminary preparations

1. The access point (wireless router) supports Wi-Fi Protected Setup (WPS).
2. A printer that has wireless network function.

5.1.2.2.Wi-Fi Protected Setup (WPS) method

1. Turn on the power of printer and access point (wireless router).
2. Make sure the printer is in ready state.



Note: • If the printer is in sleep mode, it can be woken up by pressing any key on the control panel of printer.

3. Press the “Wi-Fi key” on the control panel of printer for more than 2s until the blue Wi-Fi indicator of printer blinks, and then release pressing.
4. Press the WPS key on access point (wireless router) within 2min and then release it.
5. When the access point (wireless router) and printer start to connect, the blue Wi-Fi indicator of printer starts to blink. The blue Wi-Fi indicator of printer will be normally on after successful connection .

If the connection is not established after more than 2min, the printer will return to its ready state, the Wi-Fi indicator will be off and Wi-Fi Protected Setup (WPS) connection will fail. If it is needed to connect again, please repeat steps 3-4 above.



Note: • After successful Wi-Fi Protected Setup (WPS) connection, please install a driver if you want to print via wireless network.

5.1.3.How to disable the Wi-Fi network connected

Please complete the wireless network connection in infrastructure mode according to above steps. If connected, the Wi-Fi indicator on the status control panel will be always on ; now if you want to disconnect it, please press and hold this key for more than 2 seconds (the Wi-Fi indicator will be off).

5.2.Wi-Fi hotspot mode

You can establish a connection between a wireless network-enabled computer and a wireless network-enabled printer without using an access point (wireless route).

5.2.1.Preliminary preparations

- 1.Printer with Wi-Fi hotspot function.
- 2.Computer with wireless network function.

5.2.2.Wi-Fi Hot Connection

Enable Wi-Fi-Hot of the printer before connecting the printer hot. For this purpose, log in to the embedded Web server, click "Setting"->"Wireless Setting"->"Wireless Hot" to set the basic status of the hot as "Enabled".

5.2.3. Wi-Fi Hotspot Configuration

When the wireless hotspot of printer is active, the user can connect to it directly by searching. The wireless hotspot is enabled by default, and the default password is "12345678". The printer-specific SSID and password can be obtained from Wi-Fi Configuration Information Page, which can be printed out by selecting Print Wi-Fi Configuration. After establishing the connection, the configuration can be completed according to the Web configuration method.

5.3.Wireless network setup FAQs

1. The printer is not found.

- If the power of computer, access point (wireless router) or printer is turned on.
- If the computer is connected to printer with USB cable.
- If the printer supports wireless network connection.

2. SSID cannot be found when network is connected

- Inspect if the power switch of access point (wireless router) is turned on.
- The printer cannot find the SSID of the access point (wireless router) you need to connect, please check the SSID of access point and try to connect again.
- Every time when the setup of access point (wireless router) is changed, you must set up the wireless network of printer again.

3. Connection failure

- Please inspect if the safe mode and password of access point (wireless router) and printer is correct.
- Inspect the wireless receiving around printer. Signal receiving may be affected if the router is away from the printer or there is an obstacle between them.
- Turn the power of access point (wireless router) and printer off and then restart them and set up.

4. The following aspects should be inspected if the printer has problems while they are used in network:

- Inspect if the firewall software blocks communication. If the computer and printer are connected in the same network but they cannot be searched, the communication might be blocked by firewall software. Please refer to the user guide of firewall software to turn firewall off and then try to search the printer again.
- Inspect if the IP address assignment of printer is correct. You can inspect IP address by printing the network setup information page of printer out.
- Please refer to the following steps to check if printer and computer are in the same network:
 - 1) Select "Command prompt" as shown below.
 - a. Windows 8/10 system: Select "Search" button in the Start Menu and input "Command prompt" in search bar, then press the "Enter" button in the keyboard.
 - b. Windows 7/Vista/XP system: click "Start" menu-"All procedures"-"Attachment"-"Command prompt".
 - 2) Input ping and your printer IP address in popup window, and press "Enter" button.
For example: ping XXX.XXX.XXX.XXX("XXX.XXX.XXX.XXX" is printer IP address)
 - 3) If RTT is indicated in the window, that is to say your printer and computer are in the same network. If RTT is not indicated in the window, please refer to [Chapter 5](#) to re-configure the printer wireless network.



Note: • Please refer to the user guide or consult the manufacturer for information related to access point (wireless router).

Pantum Mobile Print

6

Chapter

6. Pantum Mobile Print	6-2
6.1. What's Pantum Mobile Print.....	6-2
6.2. Download Pantum Mobile Print	6-2
6.3. Supported Mobile Operating System.....	6-2
6.4. How to use mobile devices for the mobile printing	6-2
6.4.1. For Android Devices.....	6-2

6. Pantum Mobile Print

6.1. What's Pantum Mobile Print

Pantum Mobile Print is a free application, which allows users to directly print photos, documents and WebPages from the mobile terminal. Mobile Print of Pantum is applicable to Android 4.0-8.0 mobile operating system with a resolution of 480*800dpi or above and 3.5" screen. It connects your mobile device with the printer through Wi-Fi access points. You just need to install the Pantum Mobile Print application for configuring the network settings, then it will automatically detect compatible printers to print, which is very convenient and efficient.

6.2. Download Pantum Mobile Print

To download the Pantum Mobile Print application, please visit Pantum official website www.pantum.com.

6.3. Supported Mobile Operating System

Android OS 4.4-8.0 applied.

6.4. How to use mobile devices for the mobile printing

6.4.1. For Android Devices

6.4.1.1. Preliminary preparations

1. A printer that has wireless network function.
2. Android mobile device.

6.4.1.2. Operation steps

1. Turn on printer power.
2. Click "PANTUM" icon on the main screen of an Android device and the following interface will pop out.

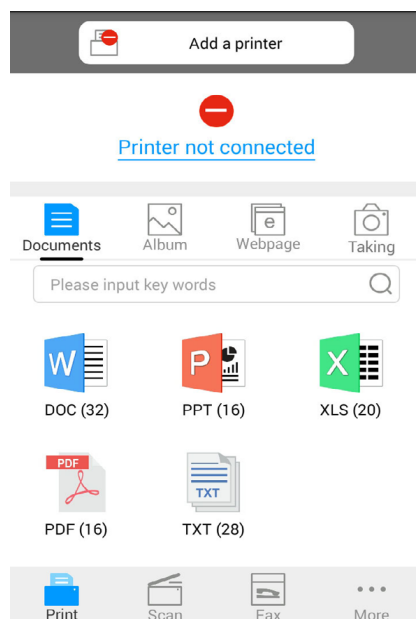

3. Click “Add printer” button at the top of interface, then select the way according to your habit to add the printer.

4. Select the function you want and then do relevant settings to meet your functional demands.



Note: • If failure of operation, please check if your Android mobile device has access to the wireless network into which your printer is connected.

• If the Android device cannot detect any printer, please inspect if power of the printer is turned on and if the printer is turned on.

• For more details, please refer to the mobile print user guide attached.

Print

7







Chapter

7. Print	7-2
7.1. Print Function	7-2
7.2. Opening Help Document	7-3
7.3. Manual Duplex	7-4
7.4. Cancel Print Job	7-7

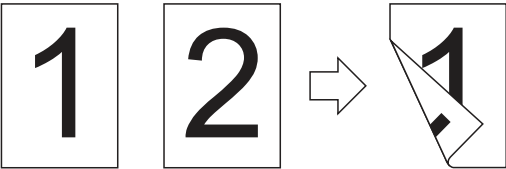
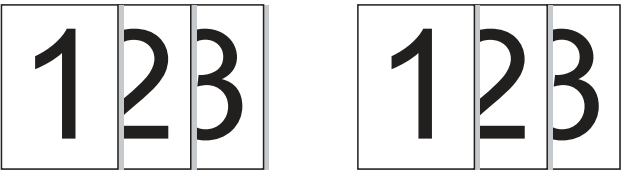
7. Print

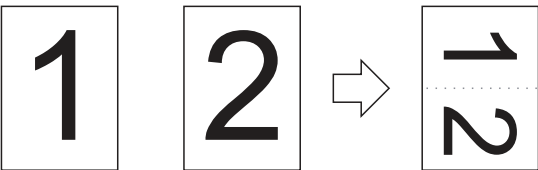
7.1. Print Function

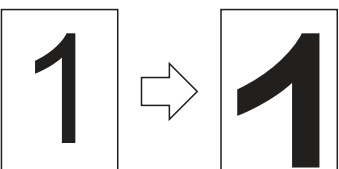
The print function can be achieved through the settings of various properties in the Printing Preferences, and some of the functions are as follows.

Functions	Diagram
Manual Duplex	
Collate	
Reverse Print	
N-in-1	
Poster Print (for Windows system only)	
Zoom Print	
Custom Size	



- Note:** • You can select the 2 x 2 Poster Print in N-in-1 to enable the poster printing function.
- You can open the Printing Preferences and click Help button to view the specific function explanation. For information about how to open the help document, see [Section 7.2](#).

7.2. Opening Help Document

You can open the Printing Preferences and click Help button (for Windows system only). The help document contains the user guide where you can find the information on print settings.

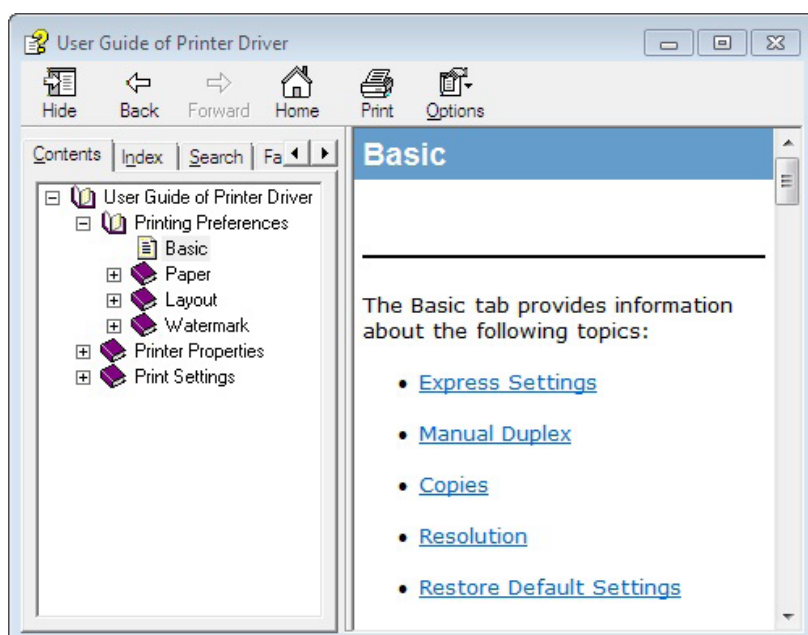
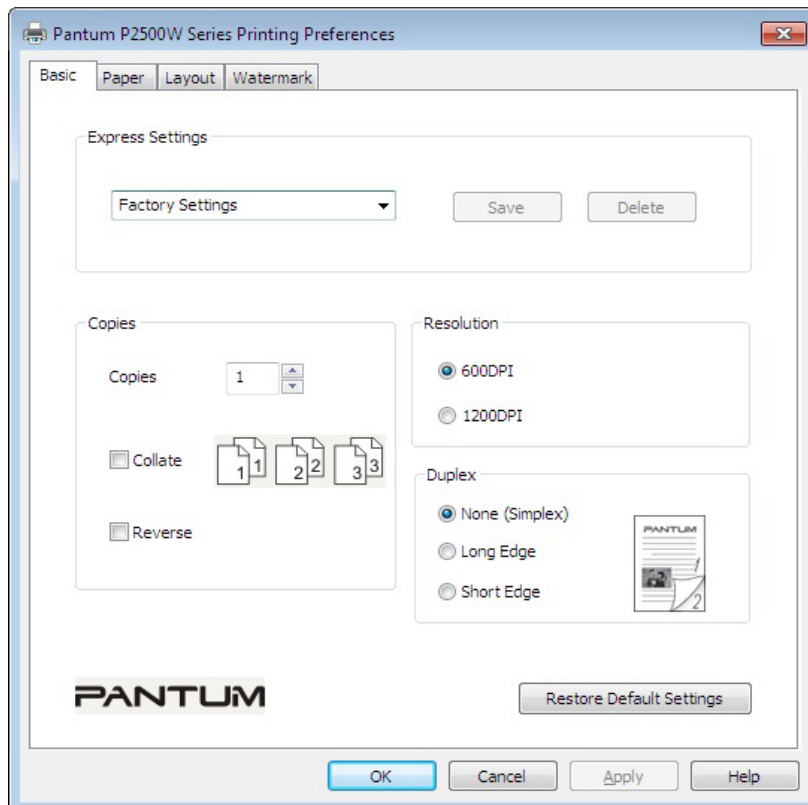

7.3. Manual Duplex

1. The printer driver supports manual duplex.



Note: • If the paper is thin, it may wrinkle.

- If the paper is curled, make it flat and put it back into the manual feeder tray or automatic feeder tray.
- If the manual duplex function causes a paper jam, see [Section 10.1](#) for handling it.

2. Ensure that certain amount of paper is loaded into the automatic feeder tray before printing.



Note: • For loading paper, see [Section 2.2](#).

- For the type of media that can be printed with the automatic feeder tray, see [Chapter 2.1](#). It is recommended to use the standard paper.
- Some paper media are not suitable for the duplex printing. Trying the duplex printing with it may damage the printer. When Paper Type is Thick or Transparency, please do not try Duplex Printing. If 2 x 2 Poster Print is checked in the Printing Preferences dialog box, Manual Duplex will not be supported.
- Paper will get jammed or cannot be fed in when the automatic feeder tray is loaded with more than 150 sheets.

3. Printing steps are as follows (for Windows system only) :

a) Open the document to be printed from the application (such as Notepad), and select Print from the File menu

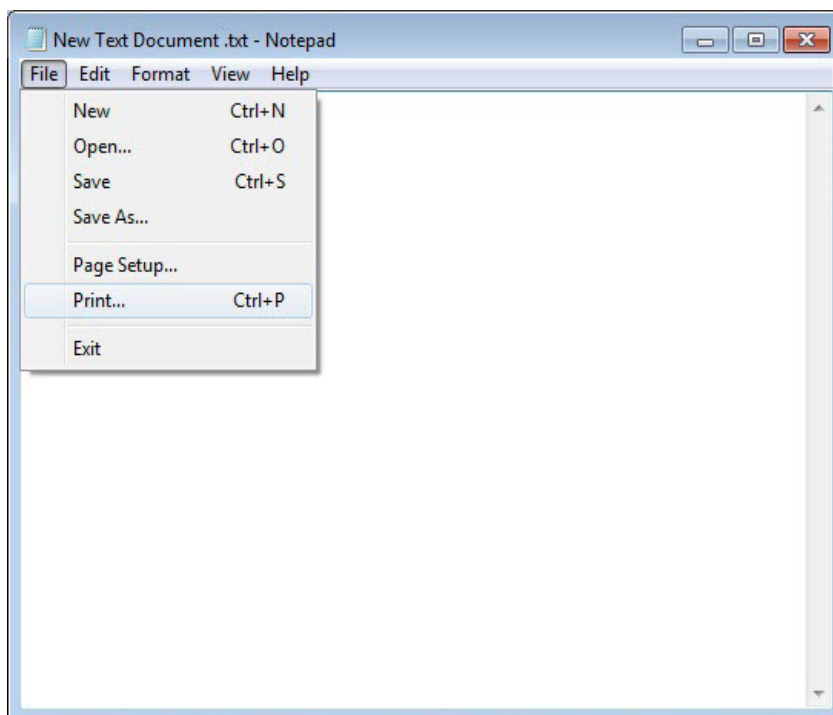

b) Select Pantum printer

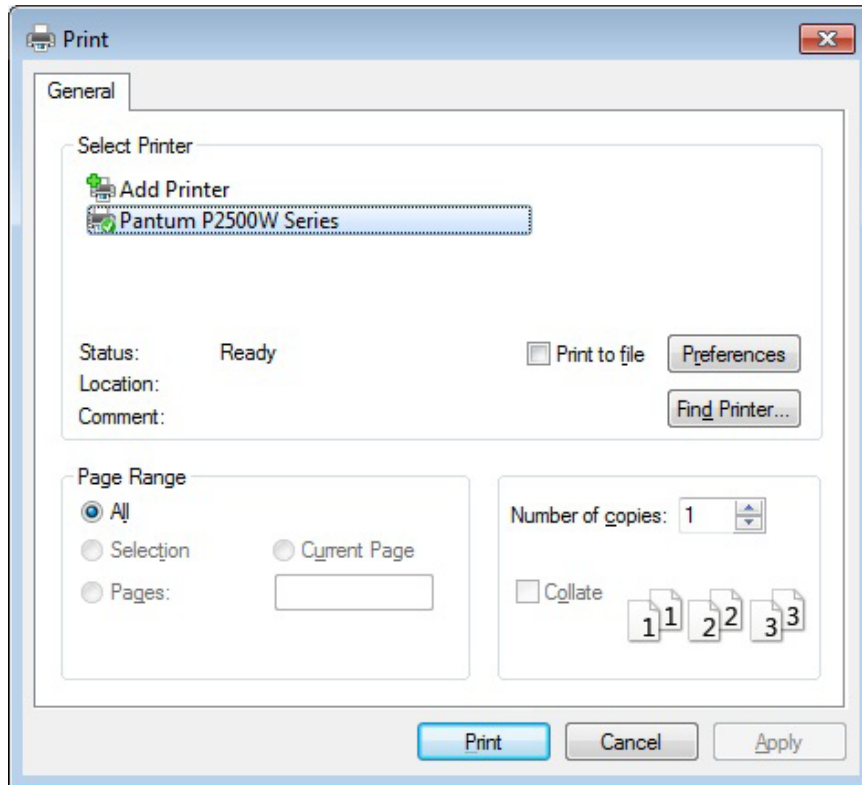

Click Preferences to set up for printing.

c) Check Manual Duplex in the Basic tab and click OK after completing the settings

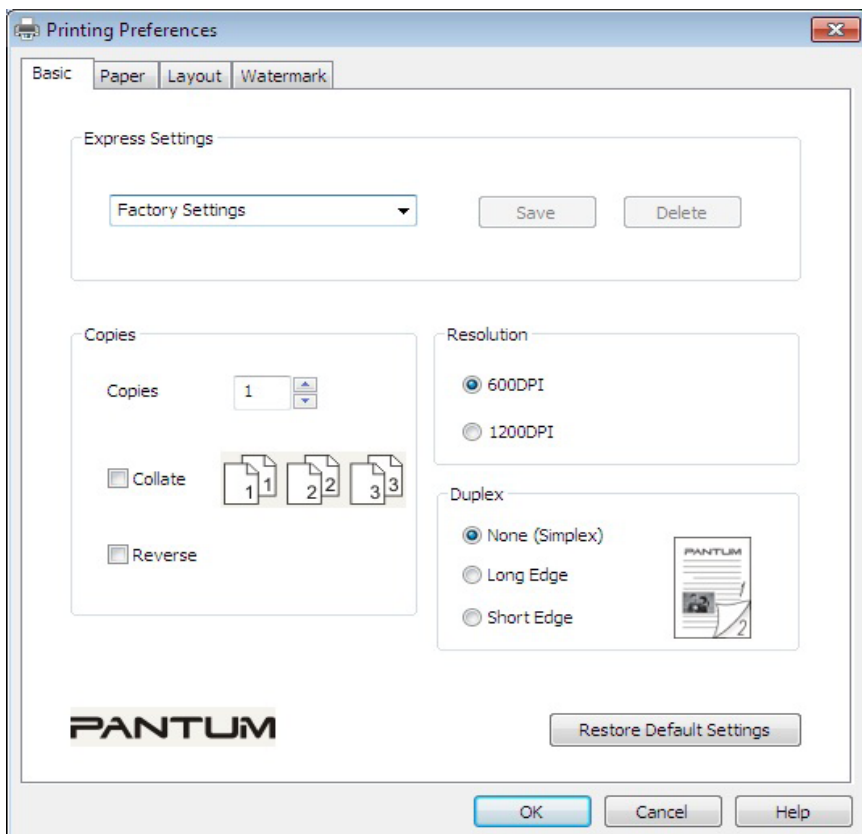

d) Click Print.

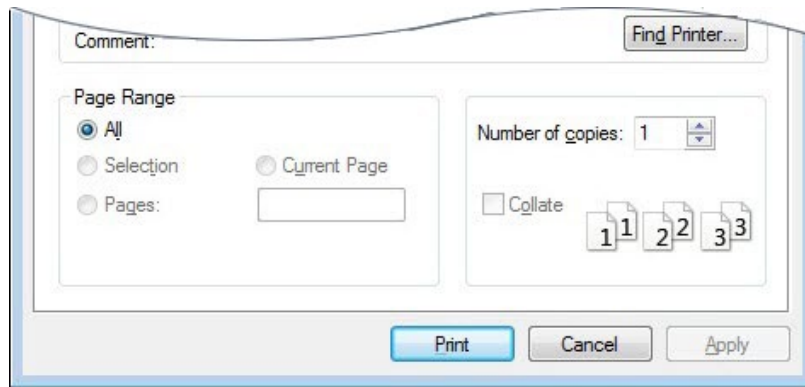

Note: • It is recommended to raise the output tray to prevent the paper from sliding out of it. If you choose not to raise the output tray, we recommend that you immediately remove the printed paper output from the printer.

e) Send the print job after choosing Manual Duplex, then the following prompt window will appear, telling you the next specific operations. Interfaces are different depending on the models.



f) After turning over the paper according to the prompt, press Continue button of the printer to go on printing the other side.

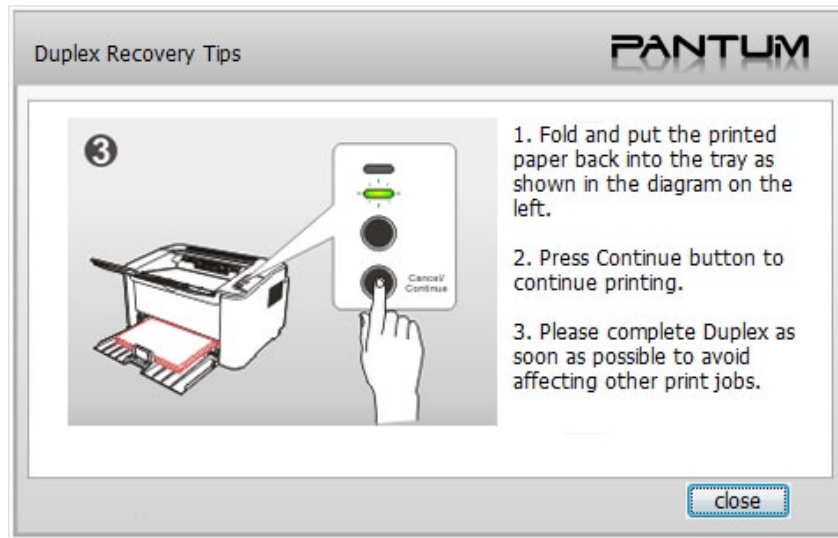

g) You can click Close button to close this prompt window, and it will not appear until the next Manual Duplex job comes in.

7.4. Cancel Print Job

Press and hold the Cancel/Continue button on the control panel to cancel the job you want to cancel during the printing process.

Control Panel

8

Chapter

8. Control Panel.....	8-2
8.1. Control Panel Overview for P2500 Series.....	8-2
8.1.1. Functions of Buttons on the Control Panel	8-2
8.1.2. Function of LED Indicators on the Control Panel.....	8-3

8. Control Panel

8.1. Control Panel Overview for P2500 Series

The printer control panel layout includes 2 buttons and 2 multi-colored LED indicators as shown below. The diagram on the left shows the control panel of the printer with USB+Wi-Fi interface, while the one on the right displays the control panel of the printer with USB interface only:

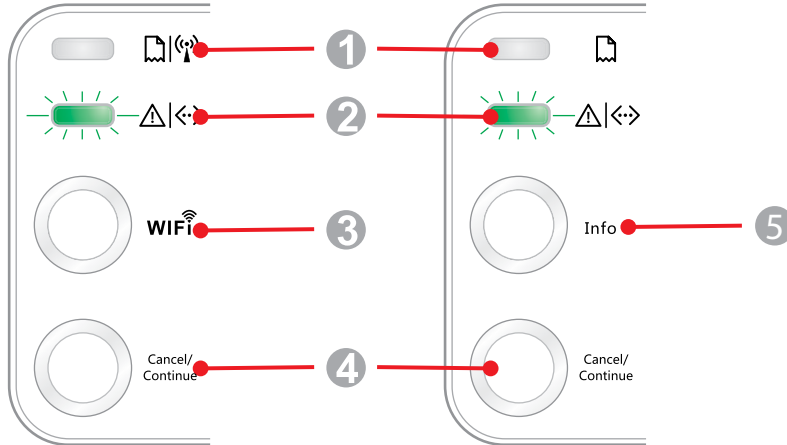

Serial No.	Name
1	Multi-colored LED1 indicator
2	Multi-colored LED2 indicator
3	Wi-Fi search button
4	Cancel/Continue button
5	Information button

8.1.1. Functions of Buttons on the Control Panel

8.1.1.1. Operation Function of Wi-Fi Search Button

If there is no Wi-Fi connection, short-press this button to launch Wi-Fi connection and search Wi-Fi Hotspot AP; stop searching if it fails to find any Access Point (AP) within 2 minutes.

If there is no Wi-Fi connection, press and hold this button to launch WPS connection, and meanwhile press the WPS button on the wireless router within 2 minutes; stop WPS connection if Wi-Fi connection cannot be established within 2 minutes.

If there is Wi-Fi connection while no Wi-Fi print job, press and hold this button to disconnect Wi-Fi connection.

If there is Wi-Fi connection and Wi-Fi print job, wait until the job is completed and then press and hold this button to disconnect the Wi-Fi connection.

During Wi-Fi connection or WPS searching, you can long press it to cancel the connection or searching.

8.1.1.2. Operation Function of Cancel/Continue Button

If the printer is in sleep mode, press or press and hold this button can wake it up.

Press and hold this button during printing can cancel the current print job.

When the printer is in ready mode, press and hold this button can print the test page.







8.1.1.3. Operation Function of Information Button

When the printer is in ready mode, press and hold this button can print the test page.

8.1.2. Function of LED Indicators on the Control Panel









8.1.2.1. LED1 Status Indication

The meanings of the status indication of LED1 are as follows:

Serial No.	Paper/Wi-Fi Multi-colored LED1 Status Indication	Status Description (For printers with USB+Wi-Fi interface)	Status Description (For printers with USB interface)
1		No Wi-Fi connection, no paper error, sleep mode LED1 off	No Wi-Fi connection, no paper error, sleep mode LED1 off
2		Searching Wi-Fi, no indication of paper error LED1 with green light flashing slowly	N/A
3		Connecting Wi-Fi..., no indication of paper error LED1 with green light flashing quickly	N/A
4		Successful Wi-Fi connection, no paper error LED1 with green light staying on	N/A
5		Paper Jam Error LED1 with red light staying on	Paper Jam Error LED1 with red light staying on
6		Paper shortage in printing, or failed in feeding LED1 with red light flashing quickly	Paper shortage in printing, or failed in feeding LED1 with red light flashing quickly























8.1.2.2. LED2 Status Indication

The meanings of the status indication of LED2 are as follows:

Serial No.	Data/ Cartridge Multi-colored LED2 Status Indication	Status Description (For printers with USB+ Wi-Fi interface and the ones with USB interface only)
1		Starting and warming up the printer, waking up and warming up the printer, and warming up the printer by opening and closing its cover. LED2 with green light flashing slowly
2		The printer is ready LED2 with green light staying on
3		Sleep LED2 with green light on and flashing slowly
4		Printing Multi-colored LED2 with green light flashing quickly
5		Alarming for toner low LED2 with orange light on and flashing quickly
6		Cartridge error (not installed, mismatch, expired) LED2 with orange light staying on
7		Serious printer error (heating roller abnormalities, laser motor abnormalities, communication error, opened cover, etc.) LED2 with red light staying on
8		A job is cancelled via the panel LED2 with light flashing quickly

8.1.2.3. Indication of LED1 and LED2 Combination Status

You can refer to the indicator combination list for information on the working status of the printer. Some of the LED1 and LED2 combined indications are as follows:

Serial No.	Status		Status Description
	Paper/Wi-Fi (Multi-colored LED1)	Data/Cartridge (Multi-colored LED2)	
1			Paper jam, the printer is ready LED1 with red light staying on, LED2 off
2			Paper jam during printing LED1 with red light staying on, multi-colored LED2 off
3			Paper jam, alarming for toner low LED1 with red light staying on, LED2 off
4			Paper jam, cartridge error (not installed, mismatch, expired) LED1 with red light staying on, LED2 off
5			Paper jam, serious printer error (heating roller abnormalities, laser motor abnormalities, communication error, opened cover, etc.) LED1 off, LED2 with red light staying on
6			Paper jam, a job is cancelled via the panel LED1 off, LED2 with green light flashing quickly
7			Paper shortage in printing, or failed in feeding, only showing paper errors LED1 with red light flashing quickly, LED2 off
8			Paper shortage in printing, or failed in feeding, alarming for toner low LED1 with red light flashing quickly, LED2 off
9			Paper shortage in printing, or failed in feeding, cartridge error (not installed, mismatch, expired) LED1 off, LED2 with orange light staying on
10			Paper shortage in printing, or failed in feeding, and meanwhile, serious printer error (heat roller abnormalities, laser motor abnormalities, communication error, opened cover, etc.) LED1 off, LED2 with red light staying on
11			A job is being cancelled via the panel because of paper shortage in printing or failure in feeding LED1 with green light off, LED2 with green light flashing quickly

Routine Maintenance

9

Chapter

9. Routine Maintenance.....	9-2
9.1. Cleaning the Printer.....	9-2
9.2. Maintenance of Laser Toner Cartridge	9-4
9.2.1. Use and Maintenance of Laser Toner Cartridge	9-4
9.2.2. Service Life of Laser Toner Cartridge.....	9-4
9.2.3. Replace Laser Toner Cartridge	9-5

9. Routine Maintenance

9.1. Cleaning the Printer



Note: • Please use mild detergents.

Please clean the printer in accordance with the following steps:

1. Turn off the main power switch and unplug the power cord and USB cable.

P2200/P2500 Series

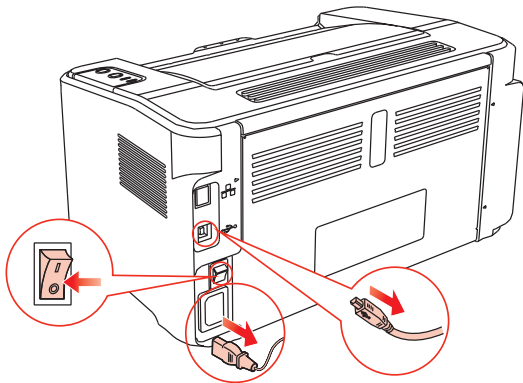

P2600 Series

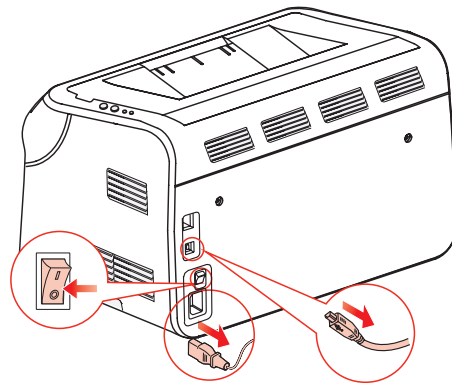

2. Use a soft cloth to wipe the outside of the printer clean.

P2200/P2500 Series

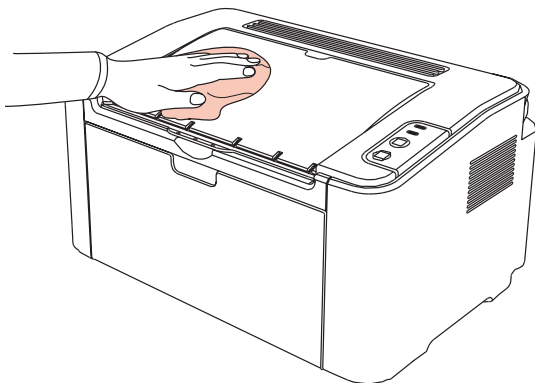

P2600 Series

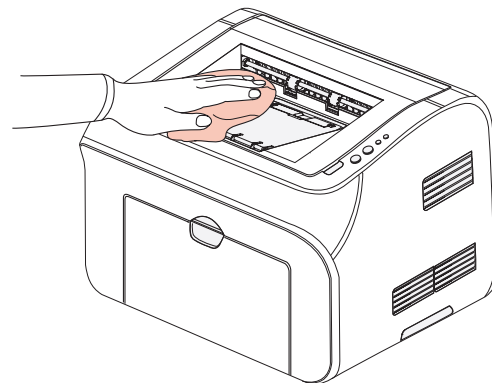

3. Open the upper cover and take out the laser toner cartridge.

P2200/P2500 Series

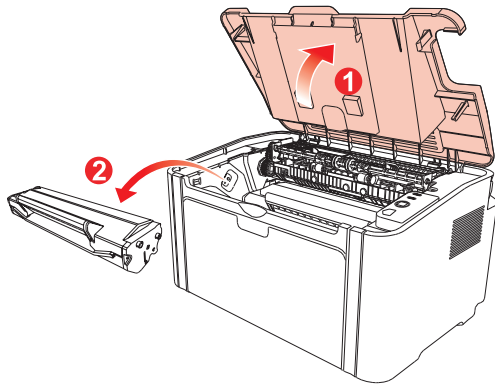

P2600 Series

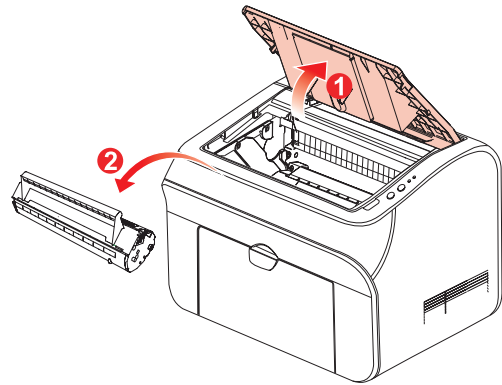

Note: • When removing the laser toner cartridge, put the cartridge in a protective bag or wrap it with thick paper to avoid direct light damaging the photosensitive drum.

4. Clean the inside of the printer by using a dry and lint-free cloth to gently wipe the shaded area as shown in the figure below.

P2200/P2500 Series

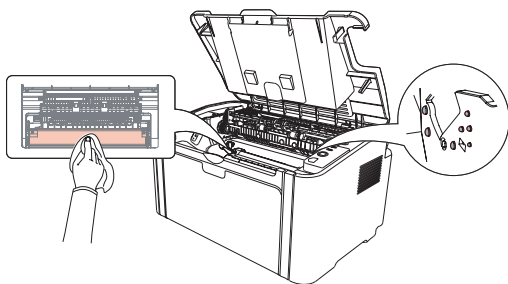

P2600 Series

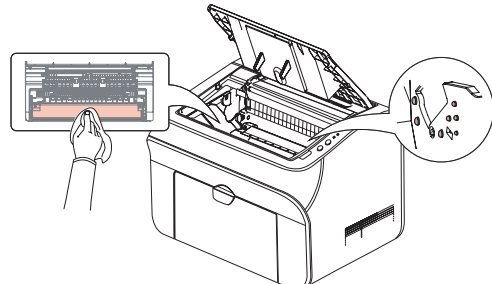

9.2. Maintenance of Laser Toner Cartridge

9.2.1. Use and Maintenance of Laser Toner Cartridge

For better print quality, please use the original Pantum laser toner cartridge.



Note: when using the laser toner cartridge, please pay attention to the following:

- Unless used immediately, otherwise, do not remove the laser toner cartridge from the package.

Do not attempt to refill the laser toner cartridge without authorization. Otherwise, the resulting damage is not included in the printer warranty.

- Please store the laser toner cartridge under a cool and dry environment.
- Toner inside the laser toner cartridge is combustible. Please do not put the laser toner cartridge near any source of ignition, so as to avoid causing a fire.
- When removing or disassembling the laser toner cartridge, please pay attention to the toner leakage problem. In case of the toner leakage resulting in that the toner contacts with your skin or splashes into your eyes and mouth, please immediately wash with clear water, and consult a doctor immediately if you feel unwell.
- When placing the laser toner cartridge, please keep it away from the area reachable by children.

9.2.2. Service Life of Laser Toner Cartridge

Service life of the laser toner cartridge depends on the amount of toner that print jobs require.

When the printer LED indicator shows the status in the following figure, it indicates that the laser toner cartridge life has expired and needs to be replaced.

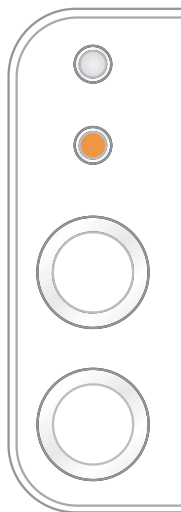

9.2.3. Replace Laser Toner Cartridge



Note: before replacing the laser toner cartridge, please pay attention to the following:

- The laser toner cartridge surface may contain toner. Please remove it carefully to avoid spilling.
- Put the removed laser toner cartridge on a piece of paper to avoid the toner from accidentally spilling.
- After removing the protective cover, please immediately install the laser toner cartridge into the printer, so as to avoid photosensitive drum damage caused by exposing to too much direct sunlight or indoor light.
- While installing the laser toner cartridge, do not touch the surface of the photosensitive drum so as not to scratch it.

Replacement steps are as follows:

1. Open the upper cover, and remove the empty laser toner cartridge along the guides.

P2200/P2500 Series

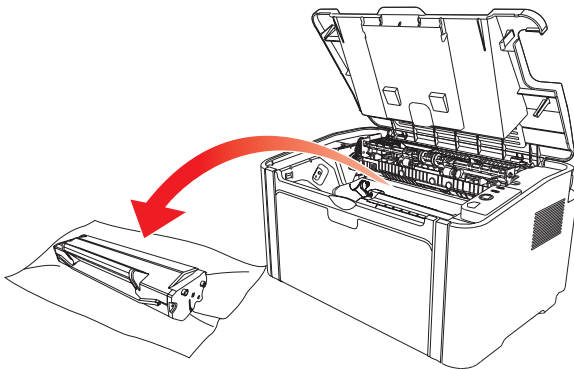

P2600 Series

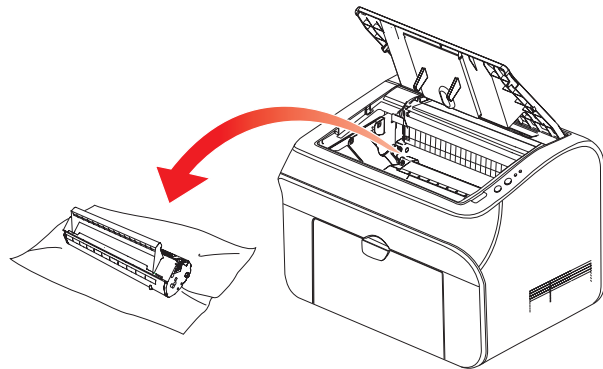

2. Open the package of a new laser toner cartridge, hold the handle of the cartridge and gently shake around 5-6 times, so as to make the toner evenly distributed inside the cartridge.

P2200/P2500 Series

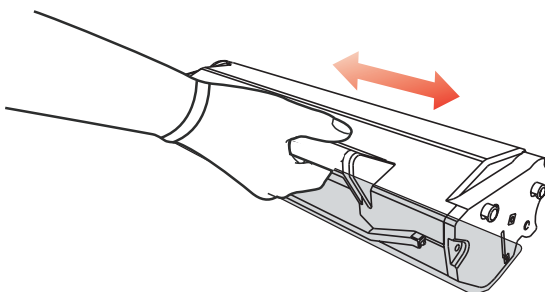

P2600 Series

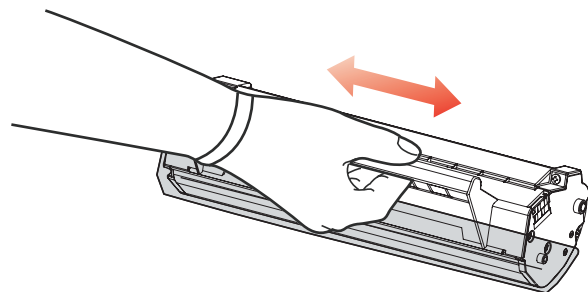

3. Remove the protective cover, and put the laser toner cartridge into the printer along the guides

P2200/P2500 Series

P2600 Series

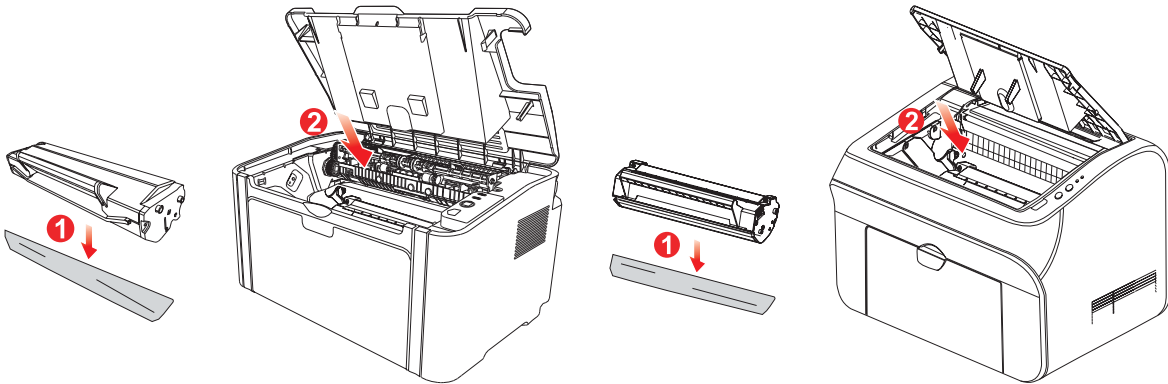

Note: • Check whether there is any seal on it before installing the laser toner cartridge into the printer; if there is any, please tear off the seal and then install the cartridge.

P2200/P2500 Series

P2600 Series

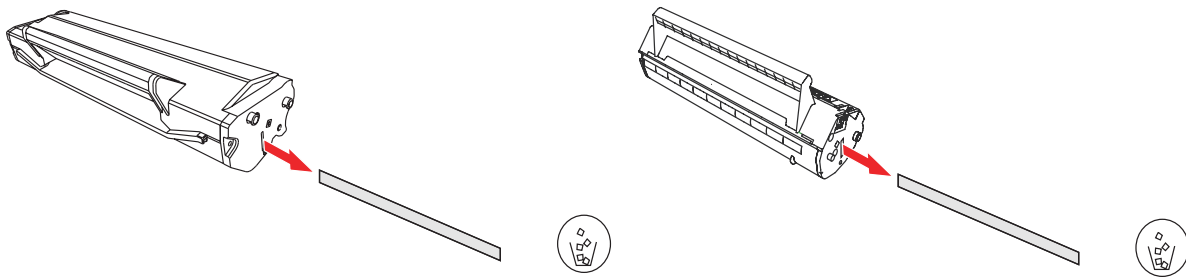

4. Close the upper cover tightly

P2200/P2500 Series

P2600 Series

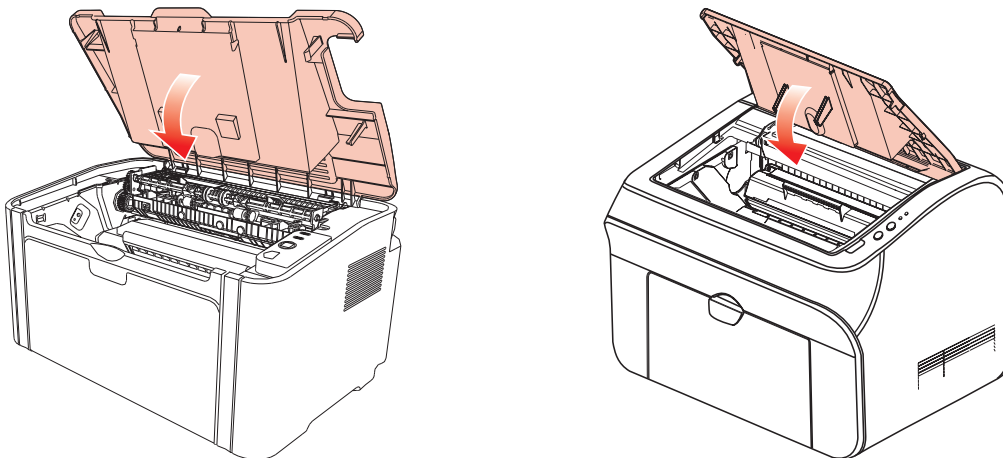

Troubleshooting

10

Chapter

10. Troubleshooting	10-2
10.1. Clearing Jammed Paper	10-2
10.1.1. Paper Jam in the Feed Port	10-3
10.1.2. Paper Jam inside the Printer.....	10-3
10.2. Common Troubleshooting.....	10-6
10.2.1. Common Trouble	10-6
10.2.2. Image Defects	10-8

10. Troubleshooting

Please read this section carefully. It can help you solve common trouble in the printing process. If the problems appeared cannot be solved, please contact Pantum Aftersales Service Center.

Prior to handling common trouble, first check that:

- The power cord is connected correctly and the printer is powered on.
- All of the protective parts are removed.
- The laser toner cartridge is correctly installed.
- The output bin is fully closed.
- The paper is correctly loaded into the tray.
- The interface cable is correctly connected between the printer and the computer.
- The correct printer driver is selected and installed properly.
- The computer port is properly configured and is connected to the proper printer port.

10.1. Clearing Jammed Paper



- Note:** • Remove the jammed paper in accordance with the following steps, close the upper cover and tidy the paper in the tray, then the printer will automatically resume printing. If the printer cannot automatically start printing, please press the button on the control panel.
- If the printer still does not start printing, please check whether all the jammed paper inside the printer are cleared.
 - If you cannot remove the jammed paper yourself, please contact your local Pantum authorized repair center or send the printer to the nearest Pantum authorized service center for repair.
-

10.1.1. Paper Jam in the Feed Port

If the output bin is open, please close it first.
Gently pull the jammed paper straight out.

P2200/P2500 Series

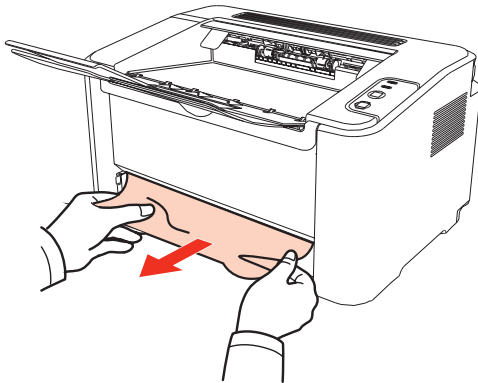

P2600 Series (automatic feeder tray and manual feeder tray)

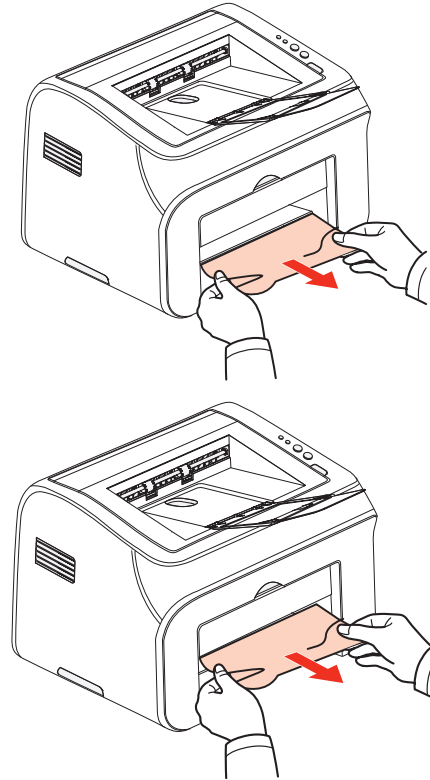

If the paper does not move while being pulled, or there is no paper in this area, please check the inside of the printer.

10.1.2. Paper Jam inside the Printer

1. Open the upper cover.

P2200/P2500 Series

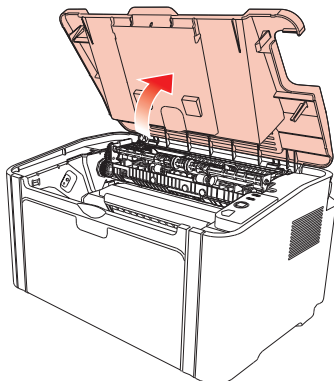

P2600 Series

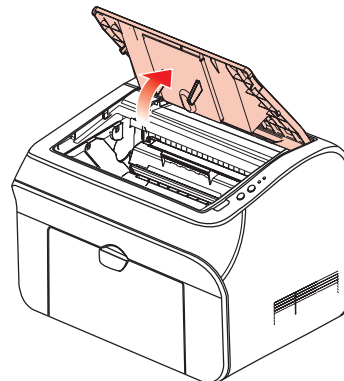

2. Open the upper fuser guide to decrease the pressure of compression spring.

P2200/P2500 Series

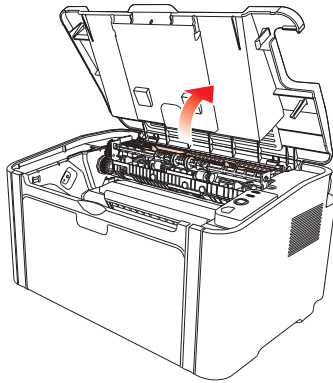

P2600 Series

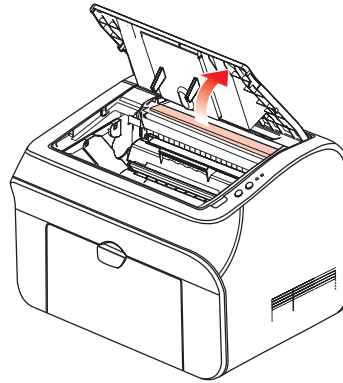

3. Pull the jammed paper out of the fuser unit.

P2200/P2500 Series

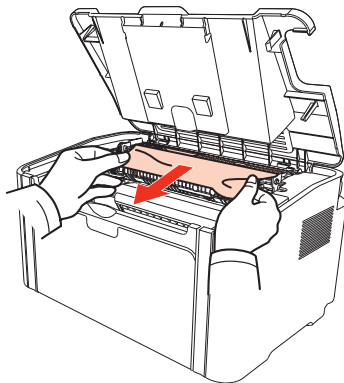

P2600 Series

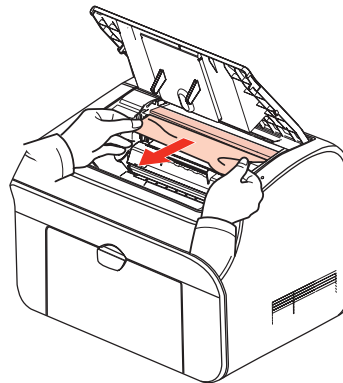

If no jammed paper is found, please go to the next step.

4. Remove the laser toner cartridge along the guides

P2200/P2500 Series

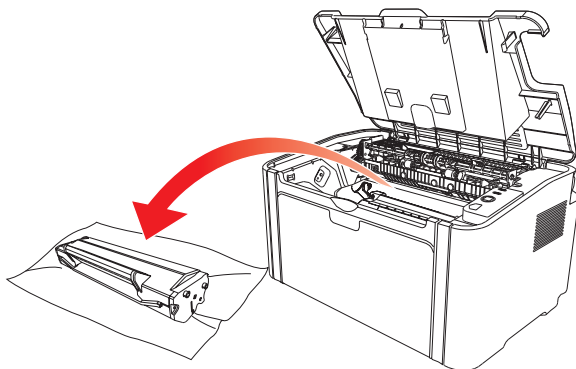

P2600 Series

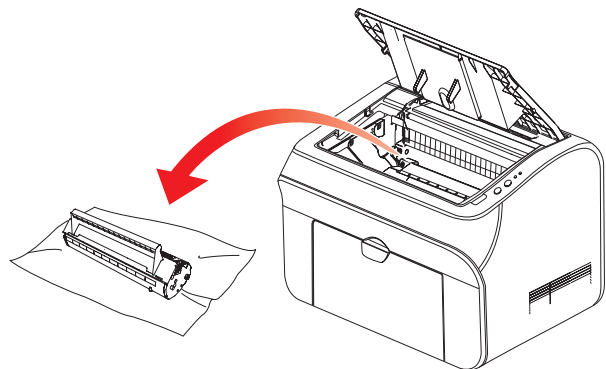

5. Slowly pull the jammed paper out along the paper output orientation.

P2200/P2500 Series

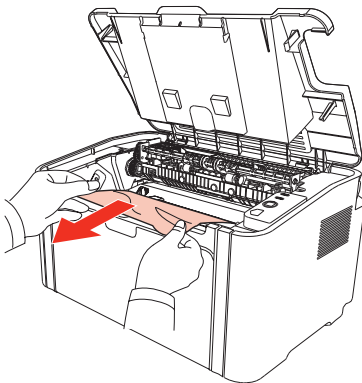

P2600 Series

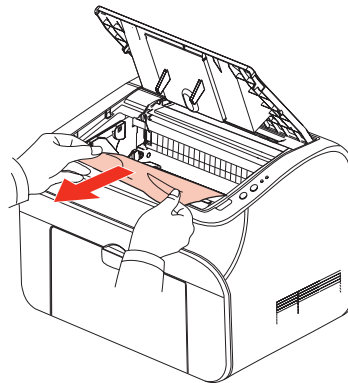

6. After removing the jammed paper, insert the laser toner cartridge into the printer along the guides until you hear a click assuring you that the cartridge is fully inserted.

P2200/P2500 Series

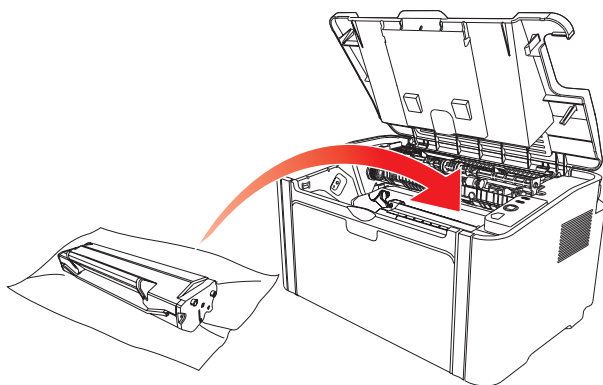

P2600 Series

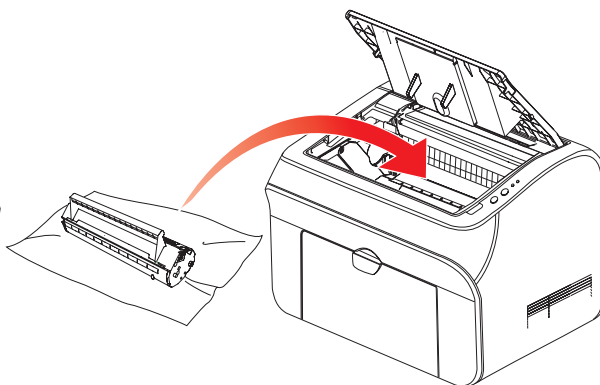

7. Put the paper in the tray neatly, and do not carry out the next print until the indicator resumes print-ready status.

P2200/P2500 Series

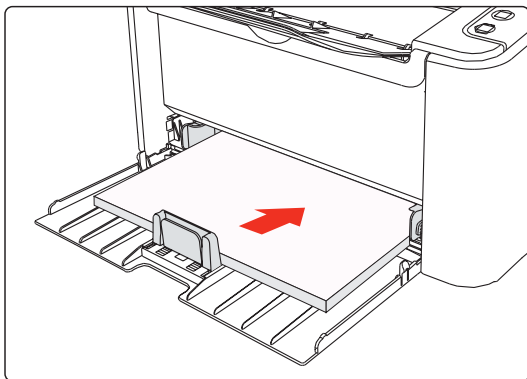

P2600 Series

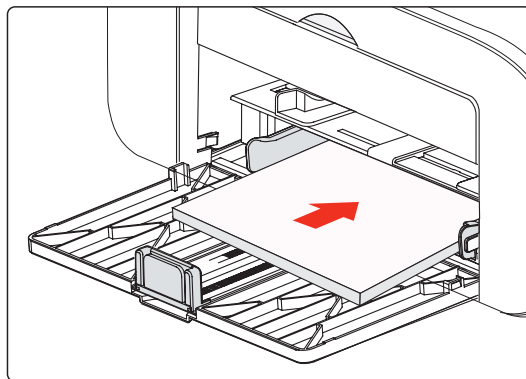

10.2. Common Troubleshooting

10.2.1. Common Trouble

Trouble	Cause	Solution
Printer Problems		
The printer does not work	<p>The cable between the computer and the printer is not connected properly.</p> <p>Error in specifying the print port.</p> <p>The printer is offline, and Use Printer Offline is checked.</p> <p>The printer does not recover from an internal error, such as a paper jam, paper empty, etc.</p>	<p>Disconnect and then reconnect the printer cable.</p> <p>Check the printer settings to ensure that the print job is sent to the correct port.</p> <p>If the computer has more than one port, make sure that the printer is connected to the correct port.</p> <p>Make sure that the printer is in the normal online status.</p>
Problems in cartridge		
The cartridge chip can not be recognized	<p>The cartridge chip is dirty.</p> <p>The contact spring or copper pillar of the cartridge chip is dirty.</p>	<p>Please clean the surface of the cartridge chip.</p> <p>Please clean the contact spring or the copper pillar.</p>
Problems in Handling Paper		
Paper feed failure	<p>The print media is loaded incorrectly.</p> <p>The print media is beyond the usage specification range.</p> <p>The feed roller is dirty.</p>	<p>Please correctly load the print media. If you use special print media for printing, please print with the manual feeder tray.</p> <p>Please use the print media within the specification range.</p> <p>Clean the feed roller.</p>
Paper Jam	<p>There is too much paper in the tray.</p> <p>The print media is beyond the usage specification range.</p> <p>There is foreign matter in the feed channel.</p> <p>The feed roller is dirty.</p> <p>Internal parts failure.</p>	<p>Remove excess paper from the tray. If you print on special print media, please use the manual feeder tray.</p> <p>Make sure to use the paper that meets specifications. If you print on special print media, please use the manual feeder tray.</p> <p>Clean the feed channel.</p> <p>Clean the feed roller.</p>
Print with multipage fed in	<p>Excessive static electricity on the print media.</p> <p>The print media is damp and sticks together.</p> <p>Internal parts failure.</p>	<p>Separate the print media to eliminate some static electricity. It is suggested that you use the recommended print media.</p> <p>Separate the print media or use better and dry print media.</p>



Trouble	Cause	Solution
Problems in Handling Paper		
The vapor comes out around the paper discharge area	The heat generated during the toner fusing causes the paper to vapor (This happens even more often when you use dampened paper under low ambient temperature)	Vapor is not an abnormality in this case, but still you can use newly unpacked paper to avoid generation of vapor. Also, keep your paper from the damp. Power off the printer and unplug the power cord when there is a smell of burning. Then consult Pantum support center. It may causes the fire or the electric shock if you continue to use the printer under this situation.

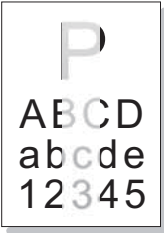
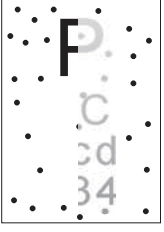
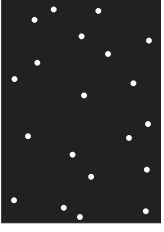
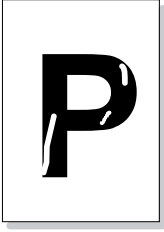
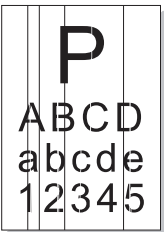

Note: • If the problem remains, please contact Pantum Customer Service.

10.2.2. Image Defects

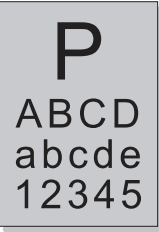
Trouble	Cause	Solution
 <p data-bbox="199 566 475 645">The printout is whitish or light</p>	<ul data-bbox="507 315 922 589" style="list-style-type: none"> • Toner is low. • The print media does not meet usage specification, such as the media is damp or too rough. • The resolution in the print program is set too low. • The laser toner cartridge is damaged. 	<ul data-bbox="975 315 1402 488" style="list-style-type: none"> • Please properly use the print media within the specification range. • Setup the print resolution in the program.
 <p data-bbox="199 902 475 947">Toner spots</p>	<ul data-bbox="507 663 930 936" style="list-style-type: none"> • The laser toner cartridge is dirty or leaks toner. • The laser toner cartridge is damaged. • The print media that does not meet usage specification, such as the media is damp or too rough. • The feed channel is dirty. 	<ul data-bbox="975 663 1345 757" style="list-style-type: none"> • Please use the print media within the specification range. • Clean the feed channel.
 <p data-bbox="199 1205 475 1249">White spots</p>	<ul data-bbox="507 965 946 1238" style="list-style-type: none"> • The print media that does not meet usage specification, such as the media is damp or too rough. • The feed channel is dirty. • The internal part of the laser toner cartridge is damaged. • The reflective glass of the laser inside the printer is dirty. 	<ul data-bbox="975 965 1402 1137" style="list-style-type: none"> • Please use the print media within the specification range. • Clean the feed channel. • Clean the reflective glass of the laser.
 <p data-bbox="199 1507 475 1552">Toner comes off</p>	<ul data-bbox="507 1267 930 1541" style="list-style-type: none"> • The print media that does not meet usage specification, such as the media is damp or too rough. • The inside of the printer is dirty. • The laser toner cartridge is damaged. • The internal part of the printer is damaged. 	<ul data-bbox="975 1267 1402 1440" style="list-style-type: none"> • Please use the print media within the specification range. If you use special print media, please print with the manual feeder tray. • Clean the inside of the printer.
 <p data-bbox="199 1821 475 1861">Black vertical stripes</p>	<ul data-bbox="507 1570 946 1776" style="list-style-type: none"> • The laser toner cartridge is dirty. • The internal part of the laser toner cartridge is damaged. • The reflective glass of the laser inside the printer is dirty. • The feed channel is dirty. 	<ul data-bbox="975 1570 1402 1709" style="list-style-type: none"> • Clean the reflective glass of the laser at the back of the printer. • Clean the feed channel at the back of the printer.

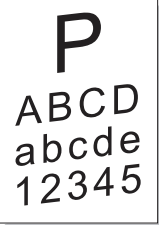
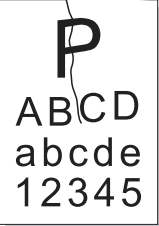
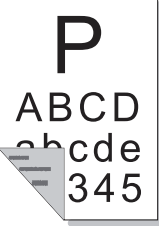
Trouble	Cause	Solution
 <p data-bbox="204 504 437 573">Black background (gray background)</p>	<ul data-bbox="512 253 954 573" style="list-style-type: none"> • The print media that does not meet usage specification, such as the media is damp or too rough. • The laser toner cartridge is dirty. • The internal part of the laser toner cartridge is damaged. • The feed channel is dirty. • The transfer voltage inside the printer is abnormal. 	<ul data-bbox="983 253 1374 389" style="list-style-type: none"> • Please use the print media within the specification range. • Clean the feed channel inside the printer.
 <p data-bbox="204 853 485 887">Cyclical traces appear</p>	<ul data-bbox="512 600 954 736" style="list-style-type: none"> • The laser toner cartridge is dirty. • The internal part of the laser toner cartridge is damaged. • The fuser component is damaged. 	<ul data-bbox="983 600 1374 770" style="list-style-type: none"> • Clean the laser toner cartridge or replace it with a new one. • Please contact Pantum Customer Service to repair and replace the fuser component.
 <p data-bbox="204 1162 392 1200">Skewed pages</p>	<ul data-bbox="512 913 954 1050" style="list-style-type: none"> • The print media is loaded incorrectly. • The feed channel of the printer is dirty. 	<ul data-bbox="983 913 1374 1050" style="list-style-type: none"> • Ensure correct loading of the print media. • Clean the feed channel inside the printer.
 <p data-bbox="204 1476 392 1514">Wrinkled paper</p>	<ul data-bbox="512 1227 954 1498" style="list-style-type: none"> • The print media is loaded incorrectly. • The print media does not meet the usage specification. • The feed channel inside the printer is dirty. • The fuser component of the printer is damaged. 	<ul data-bbox="983 1227 1374 1464" style="list-style-type: none"> • Ensure correct loading of the print media. • Please use the print media within the specification range for printing. • Clean the feed channel inside the printer.
 <p data-bbox="204 1789 405 1854">The back of the printout is dirty</p>	<ul data-bbox="512 1541 954 1711" style="list-style-type: none"> • The laser toner cartridge is dirty. • The transfer roller inside the printer is dirty. • The transfer voltage inside the printer is abnormal. 	<ul data-bbox="983 1541 1374 1677" style="list-style-type: none"> • Clean the laser toner cartridge or replace it with a new one. • Clean the internal transfer components of the printer.

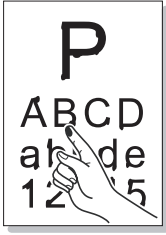
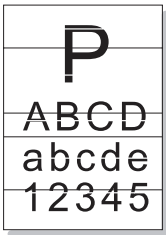
Trouble	Cause	Solution
 <p data-bbox="194 501 411 533">Whole page dark</p>	<ul style="list-style-type: none"> • The laser toner cartridge is installed incorrectly. • The internal part of the laser toner cartridge is damaged. • Abnormal charge inside the printer; the laser toner cartridge is not charged. 	<ul style="list-style-type: none"> • Ensure to install the cartridge correctly.
 <p data-bbox="194 813 443 880">The toner does not adhere to the paper</p>	<ul style="list-style-type: none"> • The print media that does not meet usage specification, such as the media is damp or too rough. • The inside of the printer is dirty. • The laser toner cartridge is damaged. • The internal part of the printer is damaged. 	<ul style="list-style-type: none"> • Please use the print media within the specification range. If you use special print media, please print with the manual feeder tray. • Clean the inside of the printer.
 <p data-bbox="194 1155 414 1187">Horizontal stripes</p>	<ul style="list-style-type: none"> • The laser toner cartridge is incorrectly installed. • The laser toner cartridge might be damaged. • The internal part of the printer is damaged. 	<ul style="list-style-type: none"> • Ensure to install the cartridge correctly.

Product Specification

11

Chapter

11. Product Specification	11-2
11.1. P2200/P2500 Series Specification.....	11-2
11.1.1. Specification Overview	11-2
11.1.2. Printing Specification.....	11-3
11.2. P2600 Series Specification	11-4
11.2.1. Specification Overview	11-4
11.2.2. Printing Specification.....	11-5

11. Product Specification

11.1. P2200/P2500 Series Specification



Note: • Specification values are slightly different for different models of printers with different functions. These values are based on the initial data. For more information about the latest specification, please visit: www.pantum.com

11.1.1. Specification Overview

Processor	600MHZ	
Memory	64MB/128MB/258MB	
Power Supply	220V Model: AC 220-240V, 50/60Hz, 3.0A 100V Model: AC 100-127V, 50/60Hz, 6.0A 110V Model: AC 110-127V, 50/60Hz, 6.0A	
Model: P2200/P2201/P2203/P2207/P2209/ P2500/P2501/P2503/P2505/P2507/ P2509/P2500W/P2500N/P2505N	(Note: For the power supply and voltage that is suitable for this printer, please refer to the nameplate on the back of the printer. Please strictly use the power supply for the printer according to its specification.)	
Networked standby power consumption	<3.0W	
Communication interface	Hi-Speed USB 2.0; Wi-Fi 802.11b/g/n	
Operation environment	Best print quality	10-32 °C
	Humidity range for operation	20 to 80% RH
Product Size (W*D*H)	about 337mm*220mm*178mm	
Weight (excluding the laser toner cartridge)	about 4.0kg (excluding the attached laser toner cartridge)	
Control Panel	LED	

11.1.2. Printing Specification

Print Speed	A4	20/22ppm
	Letter	21/23ppm
First Page Print Time		7.8s
Print Language		GDI
Maximum print size		Legal (216mm*355.6mm)
Paper Input Capacity	Standard Tray	150 pieces (80g/m ²)
Paper Output Capacity	Print-side down	100 pieces (80g/m ²)
Print Media	Media Type	Plain paper, thin paper, thick paper, transparent film, card paper, label paper, envelope
	Media size	A4, A5, JIS B5, ISO B5, A6, Letter, Legal, Executive, Folio, Oficio, Statement, Japanese Postcard, Monarch Env, DL Env, C5 Env, C6 Env, No.10 Env, ZL, Big 16K, Big 32K, 16K, 32K, B6, Yougata4, Postcard, Younaga3, Nagagata3, Yougata2.
	Media weight	60~163g/m ²

11.2. P2600 Series Specification



Note: • Specification values are slightly different for different models of printers with different functions. These values are based on the initial data. For more information about the latest specification, please visit: www.pantum.com

11.2.1. Specification Overview

Processor	600MHz	
Memory	64MB/128MB	
Power Supply	220V Model: AC 220-240V, 50/60Hz, 3.0A 100V Model: AC 100-127V, 50/60Hz, 6.0A 110V Model: AC 110-127V, 50/60Hz, 6.0A (Note: For the power supply and voltage that is suitable for this printer, please refer to the nameplate on the back of the printer. Please strictly use the power supply for the printer according to its specification.)	
Communication interface	Hi-Speed USB 2.0; Wi-Fi 802.11b/g/n 100Base-Tx Ethernet;	
Operation environment	Best print quality	10-32 °C
	Humidity range for operation	20%-80% RH
Product Size (W*D*H)	380*261*236mm	
Weight (excluding the laser toner cartridge)	about 5.3kg (excluding the attached laser toner cartridge)	
Control Panel	LED	

11.2.2. Printing Specification

Print Speed	A4	24ppm
	Letter	25ppm
First Page Print Time		< 8.5s
Print Language		GDI
Maximum print size		Legal (216mm*355.6mm)
Paper Input Capacity	Standard Tray	150 pieces (80g/m ²)
	Multipurpose Tray	1 piece (60~163g/m ²)
Paper Output Capacity	Print-side down	100 pieces (80g/m ²)
Print Media	Media Type	Plain paper, thin paper, thick paper, transparent film, card paper, label paper, envelope
	Media size	A4, A5, JIS B5, ISO B5, A6, Letter, Legal, Executive, Folio, Oficio, Statement, Japanese Postcard, Monarch Env, DL Env, C5 Env, C6 Env, No.10 Env, ZL, Big 16K, Big 32K, 16K, 32K, B6, Yougata4, Postcard, Younaga3, Nagagata3, Yougata2.
	Media weight	60~163g/m ²

PANTUM