

Service Manual

Air Conditioner

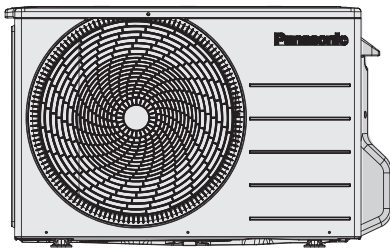
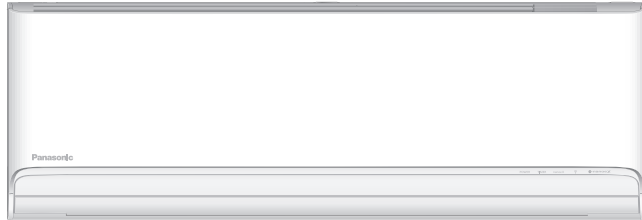

Indoor Unit
CS-Z20XKEW
CS-Z25XKEW
CS-Z35XKEW
CS-Z42XKEW
CS-XZ20XKEW
CS-XZ25XKEW
CS-XZ35XKEW

Outdoor Unit
CU-Z20XKE
CU-Z25XKE
CU-Z35XKE
CU-Z42XKE
CU-Z20XKE
CU-Z25XKE
CU-Z35XKE

Destination
Europe
Turkey

WARNING

This service information is designed for experienced repair technicians only and is not designed for use by the general public. It does not contain warnings or cautions to advise non-technical individuals of potential dangers in attempting to service a product. Products powered by electricity should be serviced or repaired only by experienced professional technicians. Any attempt to service or repair the products dealt with in this service information by anyone else could result in serious injury or death.

IMPORTANT SAFETY NOTICE

There are special components used in this equipment which are important for safety. These parts are marked by  in the Schematic Diagrams, Circuit Board Diagrams, Exploded Views and Replacement Parts List. It is essential that these critical parts should be replaced with manufacturer's specified parts to prevent shock, fire or other hazards. Do not modify the original design without permission of manufacturer.

PRECAUTION OF LOW TEMPERATURE

In order to avoid frostbite, be assured of no refrigerant leakage during the installation or repairing of refrigerant circuit.

CAUTION

R32 REFRIGERANT – This Air Conditioner contains and operates with refrigerant R32.
THIS PRODUCT MUST ONLY BE INSTALLED OR SERVICED BY QUALIFIED PERSONNEL.
 Refer to Commonwealth, State, Territory and local legislation, regulations, codes, installation & operation manuals, before the installation, maintenance and/or service of this product.

⚠ CAUTION

Before performing any of the electrical installation works, please verify on which of the intended connection use. Generally there are 2 types of indoor-outdoor connections:

- Ⓐ Single Connection (Single Indoor Unit connects with Single Outdoor Unit)
- Ⓑ Multiple Connection (Multiple Indoor Unit connect with Single Outdoor Unit)

Both connections have different connecting methods. Any mismatch connections will result in malfunctions. The following illustration demonstrates the correct electrical works for both type.

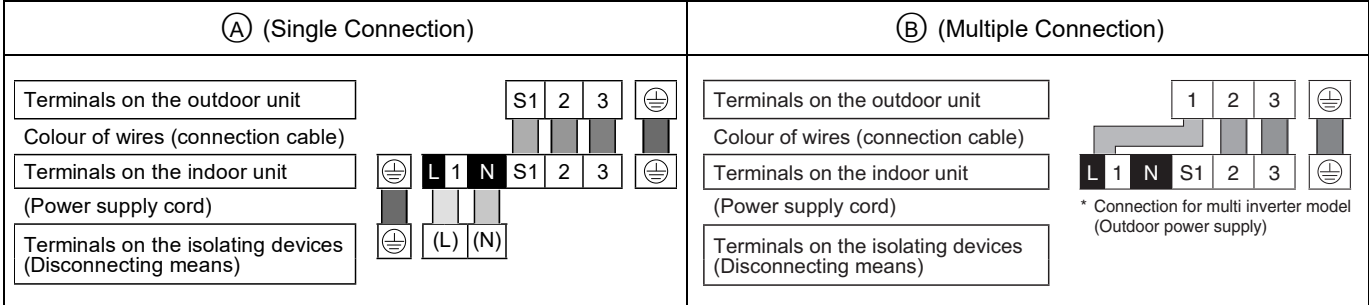

Please refer to the provided Installation Instructions for the detailed procedures for connecting cables to Indoor Unit.

TABLE OF CONTENTS



	PAGE		PAGE
1. Safety Precautions	5	14.3 Outdoor Fan Motor Operation	82
2. Precaution for Using R32 Refrigerant	8	14.4 Airflow Direction	83
3. Specifications	13	14.5 Quiet Operation (Cooling Mode/Cooling Area of Dry Mode)	86
4. Features	27	14.6 Quiet Operation (Heating)	86
5. Location of Controls and Components	28	14.7 Powerful Mode Operation	87
5.1 Indoor Unit.....	28	14.8 Timer Control.....	87
5.2 Outdoor Unit.....	28	14.9 Sleep Mode Operation	87
5.3 Remote Control	28	14.10 Auto Restart Control.....	88
6. Dimensions	29	14.11 Indication Panel.....	89
6.1 Indoor Unit.....	29	14.12 nanoe™ X Operation	89
6.2 Outdoor Unit.....	30	14.13 Mild Dry Cooling Operation	91
7. Refrigeration Cycle Diagram	31	14.14 Wireless LAN Control	91
8. Block Diagram	32	15. Operation Control	
8.1 CS-Z20XKEW CU-Z20XKE		(For Multi Split Connection)	94
CS-Z25XKEW CU-Z25XKE		15.1 Cooling operation	94
CS-XZ20XKEW CU-Z20XKE		15.2 Soft Dry Operation.....	94
CS-XZ25XKEW CU-Z25XKE	32	15.3 Heating Operation	94
8.2 CS-Z35XKEW CU-Z35XKE		15.4 Automatic Operation	95
CS-Z42XKEW CU-Z42XKE		15.5 Indoor Fan Motor Operation.....	95
CS-XZ35XKEW CU-Z35XKE	33	15.6 Powerful Mode Operation	95
9. Wiring Connection Diagram	34	15.7 Auto Restart Control.....	95
9.1 Indoor Unit.....	34	15.8 Indication Panel.....	95
9.2 Outdoor Unit.....	35	15.9 Mild Dry Cooling Operation	95
10. Electronic Circuit Diagram	37	16. Protection Control	96
10.1 Indoor Unit.....	37	16.1 Protection Control for All Operations.....	96
10.2 Outdoor Unit.....	38	16.2 Protection Control for Cooling & Soft Dry Operation.....	98
11. Printed Circuit Board	40	16.3 Protection Control for Heating Operation ...	99
11.1 Indoor Unit.....	40	17. Servicing Mode	101
11.2 Outdoor Unit.....	42	17.1 Auto OFF/ON Button	101
12. Installation Instruction	44	17.2 Heat Only Operation	102
12.1 Select the Best Location	44	17.3 Remote Control Button.....	104
12.2 Indoor Unit.....	45	18. Troubleshooting Guide	112
12.3 Select the Best Location	55	18.1 Refrigeration Cycle System.....	112
12.4 Outdoor Unit.....	56	18.2 Breakdown Self Diagnosis Function	114
13. Installation and Servicing Air Conditioner using R32	60	18.3 Error Codes Table	115
13.1 About R32 Refrigerant	60	18.4 Self-diagnosis Method.....	117
13.2 Characteristics of R32 Refrigerant	60	19. Disassembly and Assembly Instructions	146
13.3 Refrigerant piping installation • Tools used in services	62	19.1 Indoor Electronic Controllers, Cross Flow Fan and Indoor Fan Motor Removal Procedures.....	146
13.4 New installation, Relocation, Repairing of Refrigerant Cycle System The Procedures.....	66	19.2 Outdoor Electronic Controller Removal Procedure.....	153
13.5 Piping installation of R32.....	67	19.3 Panasonic Comfort Cloud	154
13.6 Installation, Relocation, and Service.....	68	20. Technical Data	167
13.7 Repairing of refrigerant cycle / Brazing point	72	20.1 Cool Mode Performance Data.....	167
13.8 <Reference> Analysis method for no error code, no cooling / no warming	78	20.2 Heat Mode Performance Data	169
14. Operation Control	80	21. Service Data	171
14.1 Basic Function.....	80	21.1 Cool Mode Outdoor Air Temperature Characteristic	171
14.2 Indoor Fan Motor Operation.....	81	21.2 Heat Mode Outdoor Air Temperature Characteristic	177
		21.3 Piping Length Correction Factor	183

22. Exploded View and Replacement Parts



List	185
22.1 Indoor Unit.....	185
22.2 Outdoor Unit	194

1. Safety Precautions





- Read the following “SAFETY PRECAUTIONS” carefully before perform any servicing.
- Confirm the type of gas used before installation.
- Electrical work must be installed or serviced by a licensed electrician. Be sure to use the correct rating of the power plug and main circuit for the model installed.
- The caution items stated here must be followed because these important contents are related to safety. The meaning of each indication used is as below. Incorrect installation or servicing due to ignoring of the instruction will cause harm or damage, and the seriousness is classified by the following indications.

 WARNING	This indication shows the possibility of causing death or serious injury.
 CAUTION	This indication shows the possibility of causing injury or damage to properties.











- The items to be followed are classified by the symbols:

	Symbol with white background denotes item that is PROHIBITED.
	Symbol with dark background denotes item that must be carried out.







- Explanation of symbols displayed on the indoor unit or outdoor unit.

 WARNING	This symbol shows that this equipment uses a flammable refrigerant. If the refrigerant is leaked, together with an external ignition source, there is a possibility of ignition.
 CAUTION	This symbol shows that the Operation Manual should be read carefully.
 CAUTION	This symbol shows that a service personnel should be handling this equipment with reference to the Installation Manual.
 CAUTION	This symbol shows that there is information included in the Operation Manual and/or Installation Manual.

- Carry out test run to confirm that no abnormality occurs after the servicing. Then, explain to user the operation, care and maintenance as stated in instructions. Please remind the customer to keep the operating instructions for future reference.

 WARNING	
1.	Do not use means to accelerate the defrosting process or to clean, other than those recommended by the manufacturer. Any unfit method or using incompatible material may cause product damage, burst and serious injury. 
2.	Do not install outdoor unit near handrail of veranda. When installing air-conditioner unit on veranda of a high rise building, child may climb up to outdoor unit and cross over the handrail causing an accident. 
3.	Do not use unspecified cord, modified cord, joint cord or extension cord for power supply cord. Do not share the single outlet with other electrical appliances. Poor contact, poor insulation or over current will cause electrical shock or fire. 
4.	Do not tie up the power supply cord into a bundle by band. Abnormal temperature rise on power supply cord may happen. 
5.	Do not insert your fingers or other objects into the unit, high speed rotating fan may cause injury. 
6.	Do not sit or step on the unit, you may fall down accidentally. 
7.	Keep plastic bag (packaging material) away from small children, it may cling to nose and mouth and prevent breathing. 
8.	When installing or relocating air conditioner, do not let any substance other than the specified refrigerant, eg. air etc mix into refrigeration cycle (piping). Mixing of air etc. will cause abnormal high pressure in refrigeration cycle and result in explosion, injury etc. 
9.	Do not pierce or burn as the appliance is pressurized. Do not expose the appliance to heat, flame, sparks, or other sources of ignition. Else, it may explode and cause injury or death. 
10.	Do not add or replace refrigerant other than specified type. It may cause product damage, burst and injury etc. 
11.	<ul style="list-style-type: none"> • For R32/R410A model, use piping, flare nut and tools which is specified for R32/R410A refrigerant. Using of existing (R22) piping, flare nut and tools may cause abnormally high pressure in the refrigerant cycle (piping), and possibly result in explosion and injury. For R32 and R410A, the same flare nut on the outdoor unit side and pipe can be used. • Since the working pressure for R32/R410A is higher than that of refrigerant R22 model, replacing conventional piping and flare nuts on the outdoor unit side are recommended. • If reuse piping is unavoidable, refer to instruction “IN CASE OF REUSING EXISTING REFRIGERANT PIPING” • Thickness of copper pipes used with R32/R410A must be more than 0.8 mm. Never use copper pipes thinner than 0.8 mm. • It is desirable that the amount of residual oil less than 40 mg/10 m.

12.	Engage authorized dealer or specialist for installation and servicing. If installation or servicing done by the user is incorrect, it will cause water leakage, electrical shock or fire.
13.	For refrigeration system work, install according to this installation instructions strictly. If installation is defective, it will cause water leakage, electrical shock or fire.
14.	Use the attached accessories parts and specified parts for installation and servicing. Otherwise, it will cause the set to fall, water leakage, fire or electrical shock.
15.	Install at a strong and firm location which is able to withstand weight of the set. If the strength is not enough or installation is not properly done, the set will drop and cause injury.
16.	For electrical work, follow the national regulation, legislation and this installation instructions. An independent circuit and single outlet must be used. If electrical circuit capacity is not enough or defect found in the electrical work, it will cause electrical shock or fire.
17.	Do not use joint cable for indoor / outdoor connection cable. Use the specified indoor/outdoor connection cable, refer to instruction CONNECT THE CABLE TO THE INDOOR UNIT and connect tightly for indoor/outdoor connection. Clamp the cable so that no external force will have impact on the terminal. If connection or fixing is not perfect, it will cause heat up or fire at the connection.
18.	Wire routing must be properly arranged so that control board cover is fixed properly. If control board cover is not fixed perfectly, it will cause fire or electrical shock.
19.	This equipment is strongly recommended to be installed with Earth Leakage Circuit Breaker (ELCB) or Residual Current Device (RCD), with sensitivity of 30mA at 0.1 sec or less. Otherwise, it may cause electrical shock and fire in case of equipment breakdown or insulation breakdown.
20.	During installation, install the refrigerant piping properly before running the compressor. Operation of compressor without fixing refrigeration piping and valves at opened position will cause suck-in of air, abnormal high pressure in refrigeration cycle and result in explosion, injury etc.
21.	During pump down operation, stop the compressor before removing the refrigeration piping. Removal of refrigeration piping while compressor is operating and valves are opened will cause suck-in of air, abnormal high pressure in refrigeration cycle and result in explosion, injury etc.
22.	Tighten the flare nut with torque wrench according to specified method. If the flare nut is over-tightened, after a long period, the flare may break and cause refrigerant gas leakage.
23.	After completion of installation or service, confirm there is no leakage of refrigerant gas. It may generate toxic gas when the refrigerant contacts with fire.
24.	Ventilate if there is refrigerant gas leakage during operation. It may cause toxic gas when the refrigerant contacts with fire.
25.	Be aware that refrigerants may not contain an odour.
26.	This equipment must be properly earthed. Earth line must not be connected to gas pipe, water pipe, earth of lightning rod and telephone. Otherwise, it may cause electrical shock in case of equipment breakdown or insulation breakdown.
27.	Do not modify the machine, part, material during repairing service.
28.	If wiring unit is supplied as repairing part, do not repair or connect the wire even only partial wire break. Exchange the whole wiring unit.
29.	Do not wrench the fasten terminal. Pull it out or insert it straightly.
30.	Must not use other parts except original parts describe in catalog and manual.

 CAUTION	
1.	Do not install the unit in a place where leakage of flammable gas may occur. In case gas leaks and accumulates at surrounding of the unit, it may cause fire. 
2.	Prevent liquid or vapor from entering sumps or sewers since vapor is heavier than air and may form suffocating atmospheres. 
3.	Do not release refrigerant during piping work for installation, servicing, re-installation and during repairing refrigeration parts. Take care of the liquid refrigerant, it may cause frostbite. 
4.	Do not install this appliance in a laundry room or other location where water may drip from the ceiling, etc. 
5.	Do not touch the sharp aluminium fin, sharp parts may cause injury.  
6.	Carry out drainage piping as mentioned in installation, servicing, instructions. If drainage is not perfect, water may enter the room and damage the furniture.
7.	Select an installation location which is easy for maintenance. Incorrect installation, service or repair of this air conditioner may increase the risk of rupture and this may result in loss damage or injury and/or property.
8.	Power supply connection to the room air conditioner. Use power supply cord 3 x 1.5 mm ² (3/4 ~ 1.75HP), 3 x 2.5 mm ² (2.0 ~ 2.5HP) type designation 60245 IEC 57 or heavier cord. Connect the power supply cord of the air conditioner to the mains using one of the following method. Power supply point should be in easily accessible place for power disconnection in case of emergency. In some countries, permanent connection of this air conditioner to the power supply is prohibited. 1) Power supply connection to the receptacle using power plug. Use an approved 15/16A (3/4 ~ 1.75HP), 16A (2.0HP), 20A (2.5HP) power plug with earth pin for the connection to the socket. 2) Power supply connection to a circuit breaker for the permanent connection. Use an approved 16A (3/4 ~ 2.0HP), 20A (2.5HP) circuit breaker for the permanent connection. It must be a double pole switch with a minimum 3.0 mm contact gap.

 **CAUTION**

- | | |
|-----|---|
| 9. | Installation or servicing work.
It may need two people to carry out the installation or servicing work. |
| 10. | Keep any required ventilation openings clear of obstruction. |
| 11. | Pb free solder has a higher melting point than standard solder; typically the melting point is 50°F – 70°F (30°C – 40°C) higher.
Please use a high temperature solder iron. In case of the soldering iron with temperature control, please set it to 700 ± 20°F (370 ± 10°C).
Pb free solder will tend to splash when heated too high (about 1100°F / 600°C). |
| 12. | Do not touch the sharp aluminum fins or edges of metal parts.
If you are required to handle sharp parts during installation or servicing, please wear hand glove.
Sharp parts may cause injury. |
| 13. | Tighten the flare nut with torque wrench according to specified method. If the flare nut is over-tightened, after a long period, the flare may break and cause refrigerant gas leakage. |
| 14. | Do not touch outdoor unit air inlet and aluminium fin. It may cause injury. |



2. Precaution for Using R32 Refrigerant

- The basic installation work procedures are the same as conventional refrigerant (R410A, R22) models. However, pay careful attention to the following points:

 WARNING	
1.	When connecting flare at indoor side, make sure that the flare connection is used only once, if torqued up and released, the flare must be remade. Once the flare connection was torqued up correctly and leak test was made, thoroughly clean and dry the surface to remove oil, dirt and grease by following instructions of silicone sealant. Apply neutral cure (Alkoxy type) & ammonia-free silicone sealant that is noncorrosive to copper & brass to the external of the flared connection to prevent the ingress of moisture on both the gas & liquid sides. (Moisture may cause freezing and premature failure of the connection).
2.	The appliance shall be stored, installed and operated in a well ventilated room with indoor floor area larger than A_{min} (m^2) [refer Table A] and without any continuously operating ignition source. Keep away from open flames, any operating gas appliances or any operating electric heater. Else, it may explode and cause injury or death.
3.	The mixing of different refrigerants within a system is prohibited. Models that use refrigerant R32 and R410A have a different charging port thread diameter to prevent erroneous charging with refrigerant R22 and for safety. Therefore, check beforehand. [The charging port thread diameter for R32 and R410A is 12.7 mm (1/2 inch).]
4.	Ensure that foreign matter (oil, water, etc.) does not enter the piping. Also, when storing the piping, securely seal the opening by pinching, taping, etc. (Handling of R32 is similar to R410A.)
5.	Operation, maintenance, repairing and refrigerant recovery should be carried out by trained and certified personnel in the use of flammable refrigerants and as recommended by the manufacturer. Any personnel conducting an operation, servicing or maintenance on a system or associated parts of the equipment should be trained and certified.
6.	Any part of refrigerating circuit (evaporators, air coolers, AHU, condensers or liquid receivers) or piping should not be located in the proximity of heat sources, open flames, operating gas appliance or an operating electric heater.
7.	The user/owner or their authorized representative shall regularly check the alarms, mechanical ventilation and detectors, at least once a year, where as required by national regulations, to ensure their correct functioning.
8.	A logbook shall be maintained. The results of these checks shall be recorded in the logbook.
9.	In case of ventilations in occupied spaces shall be checked to confirm no obstruction.
10.	Before a new refrigerating system is put into service, the person responsible for placing the system in operation should ensure that trained and certified operating personnel are instructed on the basis of the instruction manual about the construction, supervision, operation and maintenance of the refrigerating system, as well as the safety measures to be observed, and the properties and handling of the refrigerant used.
11.	The general requirement of trained and certified personnel are indicated as below: a) Knowledge of legislation, regulations and standards relating to flammable refrigerants; and, b) Detailed knowledge of and skills in handling flammable refrigerants, personal protective equipment, refrigerant leakage prevention, handling of cylinders, charging, leak detection, recovery and disposal; and, c) Able to understand and to apply in practice the requirements in the national legislation, regulations and Standards; and, d) Continuously undergo regular and further training to maintain this expertise.
12.	Air-conditioner piping in the occupied space shall be installed in such a way to protect against accidental damage in operation and service.
13.	Precautions shall be taken to avoid excessive vibration or pulsation to refrigerating piping.
14.	Ensure protection devices, refrigerating piping and fittings are well protected against adverse environmental effects (such as the danger of water collecting and freezing in relief pipes or the accumulation of dirt and debris).
15.	Expansion and contraction of long runs piping in refrigerating systems shall be designed and installed securely (mounted and guarded) to minimize the likelihood hydraulic shock damaging the system.
16.	Protect the refrigerating system from accidental rupture due to moving furniture or reconstruction activities.
17.	To ensure no leaking, field-made refrigerant joints indoors shall be tightness tested. The test method shall have a sensitivity of 5 grams per year of refrigerant or better under a pressure of at least 0,25 times the maximum allowable pressure (>1.04MPa, max 4.15MPa). No leak shall be detected.

 CAUTION

General

1.
 - Must ensure the installation of pipe-work shall be kept to a minimum. Avoid use dented pipe and do not allow acute bending.
 - Must ensure that pipe-work shall be protected from physical damage.
 - Must comply with national gas regulations, state municipal rules and legislation. Notify relevant authorities in accordance with all applicable regulations.
 - Must ensure mechanical connections be accessible for maintenance purposes.
 - In cases that require mechanical ventilation, ventilation openings shall be kept clear of obstruction.
 - When disposal of the product, do follow to the precautions in #12 and comply with national regulations.
 - In case of field charge, the effect on refrigerant charge caused by the different pipe length has to be quantified, measured and labelled.
 - Always contact to local municipal offices for proper handling.
 - Ensure the actual refrigerant charge is in accordance with the room size within which the refrigerant containing parts are installed.
 - Ensure refrigerant charge not to leak.
 - Wear appropriate protective equipment, including respiratory protection, as conditions warrant.
 - Keep all sources of ignition and hot metal surfaces away.

Servicing

2-1. Qualification of workers

- Any qualified person who is involved with working on or breaking into a refrigerant circuit should hold a current valid certificate from an industry-accredited assessment authority, which authorizes their competence to handle refrigerants safely in accordance with an industry recognized assessment specification.
- Servicing shall only be performed as recommended by the equipment manufacturer. Maintenance and repair requiring the assistance of other skilled personnel shall be carried out under the supervision of the person competent in the use of flammable refrigerants.
- Servicing shall be performed only as recommended by the manufacturer.
- The system is inspected, regularly supervised and maintained by a trained and certified service personnel who is employed by the person user or party responsible.

2-2. Checks to the area

- Prior to beginning work on systems containing flammable refrigerants, safety checks are necessary to ensure that the risk of ignition is minimised.
- For repair to the refrigerating system, the precautions in #2-3 to #2-7 must be followed before conducting work on the system.

2-3. Work procedure

- Work shall be undertaken under a controlled procedure so as to minimize the risk of a flammable gas or vapour being present while the work is being performed.

2-4. General work area

- All maintenance staff and others working in the local area shall be instructed and supervised on the nature of work being carried out.
- Avoid working in confined spaces. Always ensure away from source, at least 2 meter of safety distance, or zoning of free space area of at least 2 meter in radius.

2-5. Checking for presence of refrigerant

- The area shall be checked with an appropriate refrigerant detector prior to and during work, to ensure the technician is aware of potentially flammable atmospheres.
- Ensure that the leak detection equipment being used is suitable for use with flammable refrigerants, i.e. non sparking, adequately sealed or intrinsically safe.
- In case of leakage/spillage happened, immediately ventilate area and stay upwind and away from spill/release.
- In case of leakage/spillage happened, do notify persons down wind of the leaking/spill, isolate immediate hazard area and keep unauthorized personnel out.

2.

2-6. Presence of fire extinguisher

- If any hot work is to be conducted on the refrigerating equipment or any associated parts, appropriate fire extinguishing equipment shall be available at hand.
- Have a dry powder or CO2 fire extinguisher adjacent to the charging area.

2-7. No ignition sources

- No person carrying out work in relation to a refrigerating system which involves exposing any pipe work that contains or has contained flammable refrigerant shall use any sources of ignition in such a manner that it may lead to the risk of fire or explosion. He/She must not be smoking when carrying out such work.
- All possible ignition sources, including cigarette smoking, should be kept sufficiently far away from the site of installation, repairing, removing and disposal, during which flammable refrigerant can possibly be released to the surrounding space.
- Prior to work taking place, the area around the equipment is to be surveyed to make sure that there are no flammable hazards or ignition risks.
- "No Smoking" signs shall be displayed.

2-8. Ventilated area

- Ensure that the area is in the open or that it is adequately ventilated before breaking into the system or conducting any hot work.
- A degree of ventilation shall continue during the period that the work is carried out.
- The ventilation should safely disperse any released refrigerant and preferably expel it externally into the atmosphere.

2-9. Checks to the refrigerating equipment

- Where electrical components are being changed, they shall be fit for the purpose and to the correct specification.
- At all times the manufacturer's maintenance and service guidelines shall be followed.
- If in doubt consult the manufacturer's technical department for assistance.
- The following checks shall be applied to installations using flammable refrigerants.
 - The actual refrigerant charge is in accordance with the room size within which the refrigerant containing parts are installed.
 - The ventilation machinery and outlets are operating adequately and are not obstructed.
 - If an indirect refrigerating circuit is being used, the secondary circuit shall be checked for the presence of refrigerant.
 - Marking to the equipment continues to be visible and legible. Markings and signs that are illegible shall be corrected.
 - Refrigerating pipe or components are installed in a position where they are unlikely to be exposed to any substance which may corrode refrigerant containing components, unless the components are constructed of materials which are inherently resistant to being corroded or are properly protected against being so corroded.

 **CAUTION**

2-10. Checks to electrical devices

- Repair and maintenance to electrical components shall include initial safety checks and component inspection procedures.
 - Initial safety checks shall include but not limit to:-
 - That capacitors are discharged: this shall be done in a safe manner to avoid possibility of sparking.
 - That there is no live electrical components and wiring are exposed while charging, recovering or purging the system.
 - That there is continuity of earth bonding.
- 2.
- At all times the manufacturer's maintenance and service guidelines shall be followed.
 - If in doubt consult the manufacturer's technical department for assistance.
 - If a fault exists that could compromise safety, then no electrical supply shall be connected to the circuit until it is satisfactorily dealt with.
 - If the fault cannot be corrected immediately but it is necessary to continue operation, an adequate temporary solution shall be used.
 - The owner of the equipment must be informed or reported so all parties are advised thereafter.

Repairs to sealed components

- During repairs to sealed components, all electrical supplies shall be disconnected from the equipment being worked upon prior to any removal of sealed covers, etc.
 - If it is absolutely necessary to have an electrical supply to equipment during servicing, then a permanently operating form of leak detection shall be located at the most critical point to warn of a potentially hazardous situation.
 - Particular attention shall be paid to the following to ensure that by working on electrical components, the casing is not altered in such a way that the level of protection is affected. This shall include damage to cables, excessive number of connections, terminals not made to original specification, damage to seals, incorrect fitting of glands, etc.
- 3.
- Ensure that apparatus is mounted securely.
 - Ensure that seals or sealing materials have not degraded such that they no longer serve the purpose of preventing the ingress of flammable atmospheres.
 - Replacement parts shall be in accordance with the manufacturer's specifications.

NOTE: The use of silicon sealant may inhibit the effectiveness of some types of leak detection equipment. Intrinsically safe components do not have to be isolated prior to working on them.

Repair to intrinsically safe components

- Do not apply any permanent inductive or capacitance loads to the circuit without ensuring that this will not exceed the permissible voltage and current permitted for the equipment in use.
- 4.
- Intrinsically safe components are the only types that can be worked on while live in the presence of a flammable atmosphere.
 - The test apparatus shall be at the correct rating.
 - Replace components only with parts specified by the manufacturer. Unspecified parts by manufacturer may result ignition of refrigerant in the atmosphere from a leak.

Cabling

- 5.
- Check that cabling will not be subject to wear, corrosion, excessive pressure, vibration, sharp edges or any other adverse environmental effects.
 - The check shall also take into account the effects of aging or continual vibration from sources such as compressors or fans.

Detection of flammable refrigerants

- Under no circumstances shall potential sources of ignition be used in the searching or detection of refrigerant leaks.
 - A halide torch (or any other detector using a naked flame) shall not be used.
 - The following leak detection methods are deemed acceptable for all refrigerant systems.
 - No leaks shall be detected when using detection equipment with a sensitivity of 5 grams per year of refrigerant or better under a pressure of at least 0,25 times the maximum allowable pressure (>1.04MPa, max 4.15MPa) for example, a universal sniffer.
 - Electronic leak detectors may be used to detect flammable refrigerants, but the sensitivity may not be adequate, or may need re-calibration.
(Detection equipment shall be calibrated in a refrigerant-free area.)
- 6.
- Ensure that the detector is not a potential source of ignition and is suitable for the refrigerant used.
 - Leak detection equipment shall be set at a percentage of the LFL of the refrigerant and shall be calibrated to the refrigerant employed and the appropriate percentage of gas (25 % maximum) is confirmed.
 - Leak detection fluids are also suitable for use with most refrigerants, for example, bubble method and fluorescent method agents. The use of detergents containing chlorine shall be avoided as the chlorine may react with the refrigerant and corrode the copper pipe-work.
 - If a leak is suspected, all naked flames shall be removed/extinguished.
 - If a leakage of refrigerant is found which requires brazing, all of the refrigerant shall be recovered from the system, or isolated (by means of shut off valves) in a part of the system remote from the leak. The precautions in #7 must be followed to remove the refrigerant.



CAUTION

Removal and evacuation

- When breaking into the refrigerant circuit to make repairs – or for any other purpose – conventional procedures shall be used. However, it is important that best practice is followed since flammability is a consideration. The following procedure shall be adhered to:

- remove refrigerant ->
- purge the circuit with inert gas ->
- evacuate ->
- purge again with inert gas ->
- open the circuit by cutting or brazing

7.
 - The refrigerant charge shall be recovered into the correct recovery cylinders.
 - The system shall be purged with OFN to render the appliance safe. (remark: OFN = oxygen free nitrogen, type of inert gas)
 - This process may need to be repeated several times.
 - Compressed air or oxygen shall not be used for this task.
 - Purging shall be achieved by breaking the vacuum in the system with OFN and continuing to fill until the working pressure is achieved, then venting to atmosphere, and finally pulling down to a vacuum.
 - This process shall be repeated until no refrigerant is within the system.
 - When the final OFN charge is used, the system shall be vented down to atmospheric pressure to enable work to take place.
 - This operation is absolutely vital if brazing operations on the pipe work are to take place.
 - Ensure that the outlet for the vacuum pump is not close to any potential ignition sources and there is ventilation available.

Charging procedures

8.
 - In addition to conventional charging procedures, the following requirements shall be followed.
 - Ensure that contamination of different refrigerants does not occur when using charging equipment.
 - Hoses or lines shall be as short as possible to minimize the amount of refrigerant contained in them.
 - Cylinders shall be kept in an appropriate position according to the instructions.
 - Ensure that the refrigerating system is earthed prior to charging the system with refrigerant.
 - Label the system when charging is complete (if not already).
 - Extreme care shall be taken not to over fill the refrigerating system.
 - Prior to recharging the system it shall be pressure tested with OFN (refer to #7).
 - The system shall be leak tested on completion of charging but prior to commissioning.
 - A follow up leak test shall be carried out prior to leaving the site.
 - Electrostatic charge may accumulate and create a hazardous condition when charging and discharging the refrigerant. To avoid fire or explosion, dissipate static electricity during transfer by grounding and bonding containers and equipment before charging/discharging.

Decommissioning

9.
 - Before carrying out this procedure, it is essential that the technician is completely familiar with the equipment and all its details.
 - It is recommended good practice that all refrigerants are recovered safely.
 - Prior to the task being carried out, an oil and refrigerant sample shall be taken in case analysis is required prior to re-use of reclaimed refrigerant.
 - It is essential that electrical power is available before the task is commenced.
 - a) Become familiar with the equipment and its operation.
 - b) Isolate system electrically.
 - c) Before attempting the procedure ensure that:
 - mechanical handling equipment is available, if required, for handling refrigerant cylinders;
 - all personal protective equipment is available and being used correctly;
 - the recovery process is supervised at all times by a competent person;
 - recovery equipment and cylinders conform to the appropriate standards.
 - d) Pump down refrigerant system, if possible.
 - e) If a vacuum is not possible, make a manifold so that refrigerant can be removed from various parts of the system.
 - f) Make sure that cylinder is situated on the scales before recovery takes place.
 - g) Start the recovery machine and operate in accordance with instructions.
 - h) Do not over fill cylinders. (No more than 80 % volume liquid charge).
 - i) Do not exceed the maximum working pressure of the cylinder, even temporarily.
 - j) When the cylinders have been filled correctly and the process completed, make sure that the cylinders and the equipment are removed from site promptly and all isolation valves on the equipment are closed off.
 - k) Recovered refrigerant shall not be charged into another refrigeration system unless it has been cleaned and checked.
 - Electrostatic charge may accumulate and create a hazardous condition when charging or discharging the refrigerant. To avoid fire or explosion, dissipate static electricity during transfer by grounding and bonding containers and equipment before charging/discharging.

Labelling

10.
 - Equipment shall be labelled stating that it has been de-commissioned and emptied of refrigerant.
 - The label shall be dated and signed.
 - Ensure that there are labels on the equipment stating the equipment contains flammable refrigerant.

 **CAUTION**

Recovery

- When removing refrigerant from a system, either for servicing or decommissioning, it is recommended good practice that all refrigerants are removed safely.
 - When transferring refrigerant into cylinders, ensure that only appropriate refrigerant recovery cylinders are employed.
 - Ensure that the correct number of cylinders for holding the total system charge are available.
 - All cylinders to be used are designated for the recovered refrigerant and labelled for that refrigerant (i.e. special cylinders for the recovery of refrigerant).
 - Cylinders shall be complete with pressure relief valve and associated shut-off valves in good working order.
 - Recovery cylinders are evacuated and, if possible, cooled before recovery occurs.
 - The recovery equipment shall be in good working order with a set of instructions concerning the equipment that is at hand and shall be suitable for the recovery of concerning the equipment that is at hand and shall be suitable for the recovery of flammable refrigerants.
- 11.
- In addition, a set of calibrated weighing scales shall be available and in good working order.
 - Hoses shall be complete with leak-free disconnect couplings and in good condition.
 - Before using the recovery machine, check that it is in satisfactory working order, has been properly maintained and that any associated electrical components are sealed to prevent ignition in the event of a refrigerant release. Consult manufacturer if in doubt.
 - The recovered refrigerant shall be returned to the refrigerant supplier in the correct recovery cylinder, and the relevant Waste Transfer Note arranged.
 - Do not mix refrigerants in recovery units and especially not in cylinders.
 - If compressors or compressor oils are to be removed, ensure that they have been evacuated to an acceptable level to make certain that flammable refrigerant does not remain within the lubricant.
 - The evacuation process shall be carried out prior to returning the compressor to the suppliers.
 - Only electric heating to the compressor body shall be employed to accelerate this process.
 - When oil is drained from a system, it shall be carried out safely.

3. Specifications

Model		Indoor	CS-Z20XKEW, CS-XZ20XKEW			
		Outdoor	CU-Z20XKE			
Performance Test Condition		EUROVENT				
Power Supply		Phase, Hz	Single, 50			
		V	230			
			Min.	Mid.	Max	
Cooling	Capacity	kW	0.75	2.05	2.65	
		BTU/h	2560	6990	9040	
		kcal/h	650	1760	2280	
	Running Current	A	-	2.15	-	
	Input Power	W	160	450	670	
	Annual Consumption	kWh	-	225	-	
	EER CLASS		-	A	-	
	EER	W/W	4.69	4.56	3.96	
		BTU/hW	16.00	15.53	13.49	
		kcal/hW	4.06	3.91	3.40	
	ErP	Pdesign	kW	2.1		
		SEER	(W/W)	8.1		
		Annual Consumption	kWh	91		
		Class		A++		
	Power Factor	%	-	91	-	
	Indoor Noise (H / L / QLo)	dB (A)	37 / 24 / 19			
		Power Level dB (A)	53 / - / -			
	Outdoor Noise (H / L / QLo)	dB (A)	45 / - / -			
Power Level dB (A)		60 / - / -				
Heating	Capacity	kW	0.75	2.80	4.00	
		BTU/h	2560	9550	13600	
		kcal/h	650	2410	3440	
	Running Current	A	-	2.80	-	
	Input Power	W	160	620	940	
	COP CLASS		-	A	-	
	COP	W/W	4.69	4.52	4.26	
		BTU/hW	16.00	15.40	14.47	
		kcal/hW	4.06	3.89	3.66	
	ErP	Pdesign	kW	2.1		
		Tbivalent	°C	-10		
		SCOP	(W/W)	4.8		
		Annual Consumption	kWh	613		
		Class		A++		
	Power Factor	%	-	96	-	
	Indoor Noise (H / L / QLo)	dB (A)	38 / 25 / 19			
		Power Level dB (A)	54 / - / -			
	Outdoor Noise (H / L / QLo)	dB (A)	46 / - / -			
Power Level dB (A)		61 / - / -				
LOW Temp: Capacity (kW) / I. Power W) / COP		2.90 / 830 / 3.49				
EXTR LOW Temp: Capacity (kW) / I. Power W) / COP		2.38 / 840 / 2.83				
Max Current (A) / Max Input Power (W)		4.1 / 940				
Starting Current (A)		2.80				

Model			Indoor	CS-Z20XKEW, CS-XZ20XKEW	
			Outdoor	CU-Z20XKE	
Compressor	Type			Hermetic Motor / Rotary	
	Motor Type			Brushless (6-poles)	
	Output Power		W	550	
Indoor Fan	Type			Cross-flow fan	
	Material			ASG30	
	Motor Type			DC (8-pole)	
	Input Power		W	47.1	
	Output Power		W	30	
	Speed	QLo	Cool	rpm	500
			Heat	rpm	510
		Lo	Cool	rpm	580
			Heat	rpm	620
		Me	Cool	rpm	720
			Heat	rpm	780
		Hi	Cool	rpm	860
Heat			rpm	940	
SHi	Cool	rpm	920		
	Heat	rpm	1000		
Outdoor Fan	Type			Propeller Fan	
	Material			PP	
	Motor Type			DC (8-pole)	
	Input Power		W	-	
	Output Power		W	40	
	Speed	Hi	Cool	rpm	760
Heat			rpm	740	
Moisture Removal			L/h (Pt/h)	1.3 (2.7)	
Indoor Airflow	QLo	Cool	m ³ /min (ft ³ /min)	5.94 (210)	
		Heat	m ³ /min (ft ³ /min)	6.10 (215)	
	Lo	Cool	m ³ /min (ft ³ /min)	7.23 (255)	
		Heat	m ³ /min (ft ³ /min)	7.87 (278)	
	Me	Cool	m ³ /min (ft ³ /min)	9.48 (335)	
		Heat	m ³ /min (ft ³ /min)	10.44 (369)	
	Hi	Cool	m ³ /min (ft ³ /min)	11.70 (415)	
		Heat	m ³ /min (ft ³ /min)	13.00 (460)	
SHi	Cool	m ³ /min (ft ³ /min)	12.70 (449)		
	Heat	m ³ /min (ft ³ /min)	13.98 (494)		
Outdoor Airflow	Hi	Cool	m ³ /min (ft ³ /min)	27.4 (965)	
		Heat	m ³ /min (ft ³ /min)	26.7 (945)	
Refrigerant Cycle	Control Device			Expansion Valve	
	Refrigerant Oil		cm ³	FW50S (270)	
	Refrigerant Type		kg (oz)	R32, 0.67 (23.7)	
F-Gas	GWP			675	
	CO ₂ eq (ton) (Precharge Amount / Maximum Charged Amount)			0.45 / 0.50	

Model			Indoor	CS-Z20XKEW, CS-XZ20XKEW	
			Outdoor	CU-Z20XKE	
Dimension	Unit	Height (ID / OD)	mm (inch)	295 (11-5/8) / 542 (21-11/32)	
		Width (ID / OD)	mm (inch)	870 (34-9/32) / 780 (30-23/32)	
		Depth (ID / OD)	mm (inch)	229 (9-1/32) / 289 (11-13/32)	
Weight	Net (I/D / O/D)		kg (lb)	10 (22) / 25 (55)	
Piping	Pipe Diameter (Liquid / Gas)		mm (inch)	6.35 (1/4) / 9.52 (3/8)	
	Standard Length		m (ft)	5.0 (16.4)	
	Length Range (min - max)		m (ft)	3 (9.8) ~ 15 (49.2)	
	I/D & O/D Height Different		m (ft)	15.0 (49.2)	
	Additional Gas Amount		g/m (oz/ft)	10 (0.1)	
	Length for Additional Gas		m (ft)	7.5 (24.6)	
Drain Hose	Inner Diameter		mm	16.7	
	Length		mm	650	
Indoor Heat Exchanger	Fin Material			Aluminium (Pre coat)	
	Fin Type			Slit Fin	
	Row x Stage x FPI			2 x 17 x 21	
	Size (W x H x L)		mm	644.5 x 357 x 25.4	
Outdoor Heat Exchanger	Fin Material			Aluminium (Pre coat)	
	Fin Type			Corrugated Fin	
	Row x Stage x FPI			1:1 x 24:12 x 17:17	
	Size (W x H x L)		mm	36.4 x 504:252 x 713:684	
Air Filter	Material			Polypropelene	
	Type			One-touch	
Power Supply				Indoor	
Power Supply Cord				Nil	
Thermostat				Electronic Control	
Protection Device				Electronic Control	
				Dry Bulb	Wet Bulb
Indoor Operation Range	Cooling	Maximum °C (°F)		32	23
		Minimum °C (°F)		16	11
	Heating	Maximum °C (°F)		30	-
		Minimum °C (°F)		16	-
Outdoor Operation Range	Cooling	Maximum °C (°F)		43	26
		Minimum °C (°F)		-10	-
	Heating	Maximum °C (°F)		24	18
		Minimum °C (°F)		-15	-16

- Cooling capacities are based on indoor temperature of 27°C Dry Bulb (80.6°F Dry Bulb), 19.0°C Wet Bulb (66.2°F Wet Bulb) and outdoor air temperature of 35°C DRY BULB (95°F Dry Bulb), 24°C Wet Bulb (75.2°F Wet Bulb).
- Heating capacities are based on indoor temperature of 20°C Dry Bulb (68°F Dry Bulb) and outdoor air temperature of 7°C Dry Bulb (44.6°F Dry Bulb), 6°C Wet Bulb (42.8°F Wet Bulb).
- Network Impedance shall be applicable for Europe models only.
- The annual consumption is calculated by multiplying the input power by an average of 500 hours per year in cooling mode.
- EER and COP Class: Refer Att 11, RAD-A-04-06, eg. Europe: classification is at 230V only in accordance with EU directive 2003/31/EC, A – G, Australia: n star, Singapore: Tick n, etc.
- Heating low temperature capacity, Input Power and COP measured at 230 V, indoor temperature 20°C, outdoor 2/1°C.
- Heating extreme low temperature capacity, Input Power and COP measured at 230 V, indoor temperature 20°C, outdoor -7/-8°C.
- Standby power consumption ≤2.0W (when switched OFF by remote control, except under self protection control).
- Specifications are subjected to change without prior notice for further improvement.
- SEER and SCOP classification is at 230V only in accordance with EN-14825. For heating, SCOP indicates the value of only Average heating season. Other fiche data indicates in an attached sheet.

Model		Indoor	CS-Z25XKEW, CS-XZ25XKEW			
		Outdoor	CU-Z25XKE			
Performance Test Condition		EUROVENT				
Power Supply		Phase, Hz	Single, 50			
		V	230			
		Min.	Mid.	Max		
Cooling	Capacity	kW	0.85	2.50	3.50	
		BTU/h	2900	8530	11900	
		kcal/h	730	2150	3010	
	Running Current	A	-	2.40	-	
	Input Power	W	170	510	900	
	Annual Consumption	kWh	-	255	-	
	EER Class		-	A	-	
	EER	W/W	5.00	4.90	3.89	
		BTU/hW	17.06	16.73	13.22	
		kcal/hW	4.29	4.22	3.34	
	ErP	Pdesign	kW	2.5		
		SEER	(W/W)	9.4		
		Annual Consumption	kWh	93		
		Class		A+++		
	Power Factor	%	-	92	-	
	Indoor Noise (H / L / QLo)	dB (A)	39 / 25 / 19			
		Power Level dB (A)	55 / - / -			
	Outdoor Noise (H / L / QLo)	dB (A)	46 / - / -			
		Power Level dB (A)	61 / - / -			
	Heating	Capacity	kW	0.80	3.40	4.80
BTU/h			2730	11600	16400	
kcal/h			690	2920	4130	
Running Current		A	-	3.20	-	
Input Power		W	160	700	1.18k	
COP CLASS			-	A	-	
COP		W/W	5.00	4.86	4.07	
		BTU/hW	17.06	16.57	13.90	
		kcal/hW	4.31	4.17	3.50	
ErP		Pdesign	kW	2.4		
		Tbivalent	°C	-10		
		SCOP	(W/W)	5.2		
		Annual Consumption	kWh	646		
		Class		A+++		
Power Factor		%	-	95	-	
Indoor Noise (H / L / QLo)		dB (A)	41 / 27 / 19			
		Power Level dB (A)	57 / - / -			
Outdoor Noise (H / L / QLo)		dB (A)	47 / - / -			
		Power Level dB (A)	62 / - / -			
LOW Temp: Capacity (kW) / I. Power W) / COP			3.48 / 1.04k / 3.35			
EXTR LOW Temp: Capacity (kW) / I. Power W) / COP			2.80 / 1.00k / 2.80			
Max Current (A) / Max Input Power (W)			5.3 / 1.18k			
Starting Current (A)			3.20			

Model			Indoor	CS-Z25XKEW, CS-XZ25XKEW	
			Outdoor	CU-Z25XKE	
Compressor	Type			Hermetic Motor / Rotary	
	Motor Type			Brushless (6-poles)	
	Output Power		W	550	
Indoor Fan	Type			Cross-flow fan	
	Material			ASG30	
	Motor Type			DC (8-pole)	
	Input Power		W	47.1	
	Output Power		W	30	
	Speed	QLo	Cool	rpm	500
			Heat	rpm	510
		Lo	Cool	rpm	610
			Heat	rpm	670
		Me	Cool	rpm	770
			Heat	rpm	850
		Hi	Cool	rpm	920
			Heat	rpm	1010
SHi	Cool	rpm	980		
	Heat	rpm	1070		
Outdoor Fan	Type			Propeller Fan	
	Material			PP	
	Motor Type			DC (8-pole)	
	Input Power		W	-	
	Output Power		W	40	
	Speed	Hi	Cool	rpm	820
Heat			rpm	780	
Moisture Removal			L/h (Pt/h)	1.5 (3.2)	
Indoor Airflow	QLo	Cool	m ³ /min (ft ³ /min)	5.94 (210)	
		Heat	m ³ /min (ft ³ /min)	6.10 (215)	
	Lo	Cool	m ³ /min (ft ³ /min)	7.71 (272)	
		Heat	m ³ /min (ft ³ /min)	8.68 (306)	
	Me	Cool	m ³ /min (ft ³ /min)	10.28 (363)	
		Heat	m ³ /min (ft ³ /min)	11.57 (409)	
	Hi	Cool	m ³ /min (ft ³ /min)	12.70 (450)	
		Heat	m ³ /min (ft ³ /min)	14.10 (500)	
SHi	Cool	m ³ /min (ft ³ /min)	13.66 (482)		
	Heat	m ³ /min (ft ³ /min)	15.11 (534)		
Outdoor Airflow	Hi	Cool	m ³ /min (ft ³ /min)	28.70 (1015)	
		Heat	m ³ /min (ft ³ /min)	27.20 (960)	
Refrigerant Cycle	Control Device			Expansion Valve	
	Refrigerant Oil		cm ³	FW50S (270)	
	Refrigerant Type		kg (oz)	R32, 0.80 (28.2)	
F-Gas	GWP			675	
	CO ₂ eq (ton) (Precharge Amount / Maximum Charged Amount)			0.54 / 0.59	

Model			Indoor	CS-Z25XKEW, CS-XZ25XKEW	
			Outdoor	CU-Z25XKE	
Dimension	Unit	Height (ID / OD)	mm (inch)	295 (11-5/8) / 542 (21-11/32)	
		Width (ID / OD)	mm (inch)	870 (34-9/32) / 780 (30-23/32)	
		Depth (ID / OD)	mm (inch)	229 (9-1/32) / 289 (11-13/32)	
Weight	Net (I/D / O/D)		kg (lb)	10 (22) / 27 (60)	
Piping	Pipe Diameter (Liquid / Gas)		mm (inch)	6.35 (1/4) / 9.52 (3/8)	
	Standard Length		m (ft)	5.0 (16.4)	
	Length Range (min - max)		m (ft)	3 (9.8) ~ 15 (49.2)	
	I/D & O/D Height Different		m (ft)	15.0 (49.2)	
	Additional Gas Amount		g/m (oz/ft)	10 (0.1)	
	Length for Additional Gas		m (ft)	7.5 (24.6)	
Drain Hose	Inner Diameter		mm	16.7	
	Length		mm	650	
Indoor Heat Exchanger	Fin Material			Aluminium (Pre coat)	
	Fin Type			Slit Fin	
	Row x Stage x FPI			2 x 17 x 21	
	Size (W x H x L)		mm	644.5 x 357 x 25.4	
Outdoor Heat Exchanger	Fin Material			Aluminium (Pre coat)	
	Fin Type			Corrugated Fin	
	Row x Stage x FPI			2 x 24 x 19	
	Size (W x H x L)		mm	36.4 x 504 x 824.2:793.7	
Air Filter	Material			Polypropelene	
	Type			One-touch	
Power Supply				Indoor	
Power Supply Cord				NIL	
Thermostat				Electronic Control	
Protection Device				Electronic Control	
				Dry Bulb	Wet Bulb
Indoor Operation Range	Cooling	Maximum °C (°F)		32	23
		Minimum °C (°F)		16	11
	Heating	Maximum °C (°F)		30	-
		Minimum °C (°F)		16	-
Outdoor Operation Range	Cooling	Maximum °C (°F)		43	26
		Minimum °C (°F)		-10	-
	Heating	Maximum °C (°F)		24	18
		Minimum °C (°F)		-15	-16

- Cooling capacities are based on indoor temperature of 27°C Dry Bulb (80.6°F Dry Bulb), 19.0°C Wet Bulb (66.2°F Wet Bulb) and outdoor air temperature of 35°C DRY BULB (95°F Dry Bulb), 24°C Wet Bulb (75.2°F Wet Bulb).
- Heating capacities are based on indoor temperature of 20°C Dry Bulb (68°F Dry Bulb) and outdoor air temperature of 7°C Dry Bulb (44.6°F Dry Bulb), 6°C Wet Bulb (42.8°F Wet Bulb).
- Network Impedance shall be applicable for Europe models only.
- The annual consumption is calculated by multiplying the input power by an average of 500 hours per year in cooling mode.
- EER and COP Class: Refer Att 11, RAD-A-04-06, eg. Europe: classification is at 230V only in accordance with EU directive 2003/31/EC, A – G, Australia: n star, Singapore: Tick n, etc.
- Heating low temperature capacity, Input Power and COP measured at 230 V, indoor temperature 20°C, outdoor 2/1°C.
- Heating extreme low temperature capacity, Input Power and COP measured at 230 V, indoor temperature 20°C, outdoor -7/-8°C.
- Standby power consumption ≤2.0W (when switched OFF by remote control, except under self protection control).
- Specifications are subjected to change without prior notice for further improvement.
- SEER and SCOP classification is at 230V only in accordance with EN-14825. For heating, SCOP indicates the value of only Average heating season. Other fiche data indicates in an attached sheet.

Model		Indoor	CS-Z35XKEW / CS-XZ35XKEW			
		Outdoor	CU-Z35XKE			
Performance Test Condition		EUROVENT				
Power Supply		Phase, Hz	Single, 50			
		V	230			
			Min.	Mid.	Max	
Cooling	Capacity	kW	0.85	3.50	4.20	
		BTU/h	2900	11900	14300	
		kcal/h	730	3010	3610	
	Running Current	A	-	3.90	-	
	Input Power	W	200	850	1.16k	
	Annual Consumption	kWh	-	425	-	
	EER CLASS		-	A	-	
	EER	W/W	4.25	4.12	3.62	
		BTU/hW	14.5	14.00	12.33	
		kcal/hW	3.65	3.54	3.11	
	ErP	Pdesign	kW	3.5		
		SEER	(W/W)	9.5		
		Annual Consumption	kWh	129		
		Class		A+++		
	Power Factor	%	-	95	-	
	Indoor Noise (H / L / QLo)	dB (A)	42 / 28 / 19			
		Power Level dB (A)	58 / - / -			
Outdoor Noise (H / L / QLo)	dB (A)	48 / - / -				
	Power Level dB (A)	63 / - / -				
Heating	Capacity	kW	0.80	4.00	5.50	
		BTU/h	2730	13600	18800	
		kcal/h	690	3440	4730	
	Running Current	A	-	4.10	-	
	Input Power	W	180	900	1.46k	
	COP CLASS		-	A	-	
	COP	W/W	4.44	4.44	3.77	
		BTU/hW	15.17	15.11	12.88	
		kcal/hW	3.83	3.82	3.24	
	ErP	Pdesign	kW	2.8		
		Tbivalent	°C	-10		
		SCOP	(W/W)	5.2		
		Annual Consumption	kWh	754		
		Class		A+++		
	Power Factor	%	-	95	-	
	Indoor Noise (H / L / QLo)	dB (A)	43 / 33 / 19			
		Power Level dB (A)	59 / - / -			
Outdoor Noise (H / L / QLo)	dB (A)	50 / - / -				
	Power Level dB (A)	65 / - / -				
LOW Temp: Capacity (kW) / I. Power (W) / COP		3.99 / 1.29k / 3.09				
EXTR LOW Temp: Capacity (kW) / I. Power (W) / COP		3.20 / 1.26k / 2.54				
Max Current (A) / Max Input Power (W)		6.4 / 1.46k				
Starting Current (A)		4.10				

Model			Indoor	CS-Z35XKEW / CS-XZ35XKEW	
			Outdoor	CU-Z35XKE	
Compressor	Type			Hermetic Motor / Rotary	
	Motor Type			Brushless (6-poles)	
	Output Power		W	700	
Indoor Fan	Type			Cross-flow fan	
	Material			ASG30	
	Motor Type			DC (8-pole)	
	Input Power		W	47.1	
	Output Power		W	30	
	Speed	QLo	Cool	rpm	500
			Heat	rpm	510
		Lo	Cool	rpm	670
			Heat	rpm	810
		Me	Cool	rpm	830
			Heat	rpm	970
		Hi	Cool	rpm	1000
Heat			rpm	1130	
SHi	Cool	rpm	1060		
	Heat	rpm	1190		
Outdoor Fan	Type			Propeller Fan	
	Material			PP	
	Motor Type			DC (8-pole)	
	Input Power		W	-	
	Output Power		W	40	
	Speed	Hi	Cool	rpm	850
Heat			rpm	850	
Moisture Removal			L/h (Pt/h)	2.0 (4.2)	
Indoor Airflow	QLo	Cool	m ³ /min (ft ³ /min)	4.83 (171)	
		Heat	m ³ /min (ft ³ /min)	4.98 (176)	
	Lo	Cool	m ³ /min (ft ³ /min)	7.50 (265)	
		Heat	m ³ /min (ft ³ /min)	9.71 (343)	
	Me	Cool	m ³ /min (ft ³ /min)	10.02 (354)	
		Heat	m ³ /min (ft ³ /min)	12.23 (432)	
	Hi	Cool	m ³ /min (ft ³ /min)	12.70 (450)	
		Heat	m ³ /min (ft ³ /min)	14.70 (520)	
SHi	Cool	m ³ /min (ft ³ /min)	13.65 (482)		
	Heat	m ³ /min (ft ³ /min)	15.69 (554)		
Outdoor Airflow	Hi	Cool	m ³ /min (ft ³ /min)	29.80 (1050)	
		Heat	m ³ /min (ft ³ /min)	30.60 (1080)	
Refrigerant Cycle	Control Device			Expansion Valve	
	Refrigerant Oil		cm ³	FW50S (320)	
	Refrigerant Type		kg (oz)	R32, 0.89 (31.4)	
F-Gas	GWP			675	
	CO ₂ eq (ton) (Precharge Amount / Maximum Charged Amount)			0.60 / 0.65	

Model			Indoor	CS-Z35XKEW / CS-XZ35XKEW	
			Outdoor	CU-Z35XKE	
Dimension	Unit	Height (ID / OD)	mm (inch)	295 (11-5/8) / 542 (21-11/32)	
		Width (ID / OD)	mm (inch)	870 (34-9/32) / 780 (30-23/32)	
		Depth (ID / OD)	mm (inch)	229 (9-1/32) / 289 (11-13/32)	
Weight	Net (I/D / O/D)		kg (lb)	11 (24) / 30 (66)	
Piping	Pipe Diameter (Liquid / Gas)		mm (inch)	6.35 (1/4) / 9.52 (3/8)	
	Standard Length		m (ft)	5.0 (16.4)	
	Length Range (min - max)		m (ft)	3 (9.8) ~ 15 (49.2)	
	I/D & O/D Height Different		m (ft)	15.0 (49.2)	
	Additional Gas Amount		g/m (oz/ft)	10 (0.1)	
	Length for Additional Gas		m (ft)	7.5 (24.6)	
Drain Hose	Inner Diameter		mm	16.7	
	Length		mm	650	
Indoor Heat Exchanger	Fin Material			Aluminium (Pre coat)	
	Fin Type			Slit Fin	
	Row x Stage x FPI			2 x 17 x 21	
	Size (W x H x L)		mm	644.5 x 357 x 25.4	
Outdoor Heat Exchanger	Fin Material			Aluminium (Pre coat)	
	Fin Type			Corrugated Fin	
	Row x Stage x FPI			2 x 24 x 19	
	Size (W x H x L)		mm	36.4 x 504 x 824.2:793.7	
Air Filter	Material			Polypropelene	
	Type			One-touch	
Power Supply				Indoor	
Power Supply Cord				NIL	
Thermostat				Electronic Control	
Protection Device				Electronic Control	
				Dry Bulb	Wet Bulb
Indoor Operation Range	Cooling	Maximum °C (°F)		32	23
		Minimum °C (°F)		16	11
	Heating	Maximum °C (°F)		30	-
		Minimum °C (°F)		16	-
Outdoor Operation Range	Cooling	Maximum °C (°F)		43	26
		Minimum °C (°F)		-10	-
	Heating	Maximum °C (°F)		24	18
		Minimum °C (°F)		-15	-16

- Cooling capacities are based on indoor temperature of 27°C Dry Bulb (80.6°F Dry Bulb), 19.0°C Wet Bulb (66.2°F Wet Bulb) and outdoor air temperature of 35°C DRY BULB (95°F Dry Bulb), 24°C Wet Bulb (75.2°F Wet Bulb).
- Heating capacities are based on indoor temperature of 20°C Dry Bulb (68°F Dry Bulb) and outdoor air temperature of 7°C Dry Bulb (44.6°F Dry Bulb), 6°C Wet Bulb (42.8°F Wet Bulb).
- Network Impedance shall be applicable for Europe models only.
- The annual consumption is calculated by multiplying the input power by an average of 500 hours per year in cooling mode.
- EER and COP Class: Refer Att 11, RAD-A-04-06, eg. Europe: classification is at 230V only in accordance with EU directive 2003/31/EC, A – G, Australia: n star, Singapore: Tick n, etc.
- Heating low temperature capacity, Input Power and COP measured at 230 V, indoor temperature 20°C, outdoor 2/1°C.
- Heating extreme low temperature capacity, Input Power and COP measured at 230 V, indoor temperature 20°C, outdoor -7/-8°C.
- Standby power consumption ≤2.0W (when switched OFF by remote control, except under self protection control).
- Specifications are subjected to change without prior notice for further improvement.
- SEER and SCOP classification is at 230V only in accordance with EN-14825. For heating, SCOP indicates the value of only Average heating season. Other fiche data indicates in an attached sheet.

Model		Indoor	CS-Z42XKEW			
		Outdoor	CU-Z42XKE			
Performance Test Condition			EUROVENT			
Power Supply		Phase, Hz	Single, 50			
		V	230			
		Min.	Mid.	Max		
Cooling	Capacity		kW	0.85	4.20	5.00
			BTU/h	2900	14300	17100
			kcal/h	730	3610	4300
	Running Current		A	-	5.50	-
	Input Power		W	235	1.24k	1.57k
	Annual Consumption		kWh	-	620	-
	EER CLASS			-	A	-
	EER		W/W	3.62	3.39	3.18
			BTU/hW	12.34	11.53	10.89
			kcal/hW	3.11	2.91	2.74
	ErP	Pdesign		kW	4.2	
		SEER		(W/W)	7.0	
		Annual Consumption		kWh	210	
		Class			A++	
	Power Factor		%	-	98	-
	Indoor Noise (H / L / QLo)		dB (A)	43 / 31 / 25		
			Power Level dB (A)	59 / - / -		
	Outdoor Noise (H / L / QLo)		dB (A)	49 / - / -		
Power Level dB (A)			64 / - / -			
Heating	Capacity		kW	0.80	5.30	6.80
			BTU/h	2730	18100	23200
			kcal/h	690	4560	5850
	Running Current		A	-	6.40	-
	Input Power		W	190	1.44k	1.86k
	COP CLASS			-	A	-
	COP		W/W	4.21	3.68	3.66
			BTU/hW	14.37	12.57	12.47
			kcal/hW	3.63	3.17	3.15
	ErP	Pdesign		kW	3.6	
		Tbivalent		°C	-10	
		SCOP		(W/W)	4.2	
		Annual Consumption		kWh	1200	
		Class			A+	
	Power Factor		%	-	98	-
	Indoor Noise (H / L / QLo)		dB (A)	43 / 35 / 29		
			Power Level dB (A)	59 / - / -		
	Outdoor Noise (H / L / QLo)		dB (A)	51 / - / -		
Power Level dB (A)			66 / - / -			
LOW Temp: Capacity (kW) / I. Power (W) / COP			4.93 / 1.65k / 2.99			
EXTR LOW Temp: Capacity (kW) / I. Power (W) / COP			4.11 / 1.60k / 2.57			
Max Current (A) / Max Input Power (W)			8.1 / 1.84k			
Starting Current (A)			6.40			

Model			Indoor	CS-Z42XKEW	
			Outdoor	CU-Z42XKE	
Compressor	Type			Hermetic Motor / Rotary	
	Motor Type			Brushless (6-poles)	
	Output Power		W	700	
Indoor Fan	Type			Cross-flow fan	
	Material			ASG30	
	Motor Type			DC (8-pole)	
	Input Power		W	47.1	
	Output Power		W	30	
	Speed	QLo	Cool	rpm	620
			Heat	rpm	700
		Lo	Cool	rpm	730
			Heat	rpm	840
		Me	Cool	rpm	890
			Heat	rpm	960
		Hi	Cool	rpm	1030
			Heat	rpm	1090
SHi	Cool	rpm	1090		
	Heat	rpm	1150		
Outdoor Fan	Type			Propeller Fan	
	Material			PP	
	Motor Type			DC (8-pole)	
	Input Power		W	-	
	Output Power		W	40	
	Speed	Hi	Cool	rpm	850
Heat			rpm	880	
Moisture Removal			L/h (Pt/h)	2.4 (5.1)	
Indoor Airflow	QLo	Cool	m ³ /min (ft ³ /min)	7.87 (278)	
		Heat	m ³ /min (ft ³ /min)	9.16 (323)	
	Lo	Cool	m ³ /min (ft ³ /min)	9.64 (340)	
		Heat	m ³ /min (ft ³ /min)	11.41 (403)	
	Me	Cool	m ³ /min (ft ³ /min)	12.21 (431)	
		Heat	m ³ /min (ft ³ /min)	13.34 (471)	
	Hi	Cool	m ³ /min (ft ³ /min)	14.40 (510)	
		Heat	m ³ /min (ft ³ /min)	15.40 (545)	
SHi	Cool	m ³ /min (ft ³ /min)	15.43 (545)		
	Heat	m ³ /min (ft ³ /min)	16.40 (579)		
Outdoor Airflow	Hi	Cool	m ³ /min (ft ³ /min)	29.80 (1050)	
		Heat	m ³ /min (ft ³ /min)	30.90 (1090)	
Refrigerant Cycle	Control Device			Expansion Valve	
	Refrigerant Oil		cm ³	FW50S (320)	
	Refrigerant Type		kg (oz)	R32, 0.95 (33.5)	
F-Gas	GWP			675	
	CO ₂ eq (ton) (Precharge Amount / Maximum Charged Amount)			0.64 / 0.69	

Model			Indoor	CS-Z42XKEW
			Outdoor	CU-Z42XKE
Dimension	Unit	Height (ID / OD)	mm (inch)	295 (11-5/8) / 542 (21-11/32)
		Width (ID / OD)	mm (inch)	870 (34-9/32) / 780 (30-23/32)
		Depth (ID / OD)	mm (inch)	229 (9-1/32) / 289 (11-13/32)
Weight	Net (I/D / O/D)		kg (lb)	10 (22) / 30 (66)
Piping	Pipe Diameter (Liquid / Gas)		mm (inch)	6.35 (1/4) / 12.70 (1/2)
	Standard Length		m (ft)	5.0 (16.4)
	Length Range (min - max)		m (ft)	3 (9.8) ~ 15 (49.2)
	I/D & O/D Height Different		m (ft)	15.0 (49.2)
	Additional Gas Amount		g/m (oz/ft)	10 (0.1)
	Length for Additional Gas		m (ft)	7.5 (24.6)
Drain Hose	Inner Diameter		mm	16.7
	Length		mm	650
Indoor Heat Exchanger	Fin Material			Aluminium (Pre coat)
	Fin Type			Slit Fin
	Row x Stage x FPI			2 x 17 x 21
	Size (W x H x L)		mm	644.5 x 357 x 25.4
Outdoor Heat Exchanger	Fin Material			Aluminium (Pre coat)
	Fin Type			Corrugated Fin
	Row x Stage x FPI			2 x 24 x 19
	Size (W x H x L)		mm	36.4 x 504 x 824:794
Air Filter	Material			Polypropelene
	Type			One-touch
Power Supply				Indoor
Power Supply Cord				NIL
Thermostat				Electronic Control
Protection Device				Electronic Control
				Dry Bulb
				Wet Bulb
Indoor Operation Range	Cooling	Maximum °C (°F)	32	23
		Minimum °C (°F)	16	11
	Heating	Maximum °C (°F)	30	-
		Minimum °C (°F)	16	-
Outdoor Operation Range	Cooling	Maximum °C (°F)	43	26
		Minimum °C (°F)	-10	-
	Heating	Maximum °C (°F)	24	18
		Minimum °C (°F)	-15	-16

- Cooling capacities are based on indoor temperature of 27°C Dry Bulb (80.6°F Dry Bulb), 19.0°C Wet Bulb (66.2°F Wet Bulb) and outdoor air temperature of 35°C DRY BULB (95°F Dry Bulb), 24°C Wet Bulb (75.2°F Wet Bulb).
- Heating capacities are based on indoor temperature of 20°C Dry Bulb (68°F Dry Bulb) and outdoor air temperature of 7°C Dry Bulb (44.6°F Dry Bulb), 6°C Wet Bulb (42.8°F Wet Bulb).
- Network Impedance shall be applicable for Europe models only.
- The annual consumption is calculated by multiplying the input power by an average of 500 hours per year in cooling mode.
- EER and COP Class: Refer Att 11, RAD-A-04-06, eg. Europe: classification is at 230V only in accordance with EU directive 2003/31/EC, A – G, Australia: n star, Singapore: Tick n, etc.
- Heating low temperature capacity, Input Power and COP measured at 230 V, indoor temperature 20°C, outdoor 2/1°C.
- Heating extreme low temperature capacity, Input Power and COP measured at 230 V, indoor temperature 20°C, outdoor -7/-8°C.
- Standby power consumption ≤2.0W (when switched OFF by remote control, except under self protection control).
- Specifications are subjected to change without prior notice for further improvement.
- SEER and SCOP classification is at 230V only in accordance with EN-14825. For heating, SCOP indicates the value of only Average heating season. Other fiche data indicates in an attached sheet.

• **Multi Split Combination Possibility:**

- A single outdoor unit enables air conditioning of up to two separate rooms for CU-2Z35TBE, CU-2Z41TBE, CU-2Z50TBE.
- A single outdoor unit enables air conditioning of up to three separate rooms for CU-3Z68TBE, CU-3Z52TBE.

CONNECTABLE INDOOR UNIT			OUTDOOR UNIT											
			CU-2Z35TBE		CU-2Z41TBE		CU-2Z50TBE		CU-3Z68TBE			CU-3Z52TBE		
ROOM			A	B	A	B	A	B	A	B	C	A	B	C
TYPE														
Wall	1.6kW	CS-MZ16XKEW	•	•	•	•	•	•	•	•	•	•	•	•
	2.0kW	CS-Z20XKEW	•	•	•	•	•	•	•	•	•	•	•	•
		CS-XZ20XKEW	•	•	•	•	•	•	•	•	•	•	•	•
	2.5kW	CS-Z25XKEW	•	•	•	•	•	•	•	•	•	•	•	•
		CS-XZ25XKEW	•	•	•	•	•	•	•	•	•	•	•	•
	3.5kW	CS-Z35XKEW	•	–	•	–	•	•	•	•	•	•	•	•
CS-XZ35XKEW		•	–	•	–	•	•	•	•	•	•	•	•	–
4.2kW	CS-Z42XKEW	–	–	–	–	•	–	•	•	–	•	•	–	
5.0kW	CS-Z50XKEW	–	–	–	–	•	–	•	•	–	•	–	–	
	CS-XZ50XKEW	–	–	–	–	•	–	•	•	–	•	–	–	
Capacity range of connectable units			From 3.2kW to 6.0kW		From 3.2kW to 6.0kW		From 3.2kW to 7.7kW		From 4.5kW to 11.2kW			From 4.5kW to 9.5kW		
Pipe length	1 room maximum pipe length (m)		20		20		20		25			25		
	Allowable elevation (m)		10		10		10		15			15		
	Total allowable pipe length (m)		30		30		30		60			50		
	Total pipe length for maximum chargeless length (m)		20		20		20		30			30		
	Additional gas amount over chargeless length (g/m)		15		15		15		20			20		
Note: “•” : Available														
<p>Remarks for CU-2Z35TBE / CU-2Z41TBE / CU-2Z50TBE</p> <ol style="list-style-type: none"> At least two indoor units must be connected. The total nominal cooling capacity of indoor unit that will be connected to outdoor unit must be within connectable capacity range of indoor unit. (as shown in the table above) Example: The indoor units' combination below is possible to connect to CU-2Z41TBE. (Total nominal capacity of indoor units is between 3.2kW to 6.0kW) 1) Two CS-XZ20XKEW only. (Total nominal cooling capacity is 4.0kW) 														
<p>Remarks for CU-3Z68TBE / CU-3Z52TBE</p> <ol style="list-style-type: none"> At least two indoor units must be connected. The total nominal cooling capacity of indoor unit that will be connected to outdoor unit must be within connectable capacity range of indoor unit. (as shown in the table above) Example: The indoor units' combination below is possible to connect to CU-3Z68TBE. (Total nominal capacity of indoor units is between 4.5kW to 11.2kW) 1) Two CS-XZ25XKEW only. (Total nominal cooling capacity is 5.0kW) 														

• **Multi Split Combination Possibility:**

- A single outdoor unit enables air conditioning of up to four separate rooms for CU-4Z68TBE, CU-4Z80TBE.
- A single outdoor unit enables air conditioning of up to five separate rooms for CU-5Z90TBE.

CONNECTABLE INDOOR UNIT			OUTDOOR UNIT												
			CU-4Z68TBE				CU-4Z80TBE				CU-5Z90TBE				
ROOM		TYPE													
		A	B	C	D	A	B	C	D	A	B	C	D	E	
Wall	1.6kW	CS-MZ16XKEW	•	•	•	•	•	•	•	•	•	•	•	•	
	2.0kW	CS-Z20XKEW CS-XZ20XKEW	•	•	•	•	•	•	•	•	•	•	•	•	
	2.5kW	CS-Z25XKEW CS-XZ25XKEW	•	•	•	•	•	•	•	•	•	•	•	•	
	3.5kW	CS-Z35XKEW CS-XZ35XKEW	•	•	•	–	•	•	•	•	•	•	•	•	
	4.2kW	CS-Z42XKEW	•	•	–	–	•	•	•	–	•	•	•	•	–
	5.0kW	CS-Z50XKEW CS-XZ50XKEW	•	•	–	–	•	•	–	–	•	•	•	–	–
	7.1kW	CS-Z71XKEW	–	–	–	–	•	•	–	–	•	•	–	–	–
Capacity range of connectable units			From 4.5kW to 11.5kW				From 4.5kW to 14.7kW				From 4.5kW to 18.3kW				
Pipe length	1 room maximum pipe length (m)		25				25				25				
	Allowable elevation (m)		15				15				15				
	Total allowable pipe length (m)		60				70				80				
	Total pipe length for maximum chargeless length (m)		30				45				45				
	Additional gas amount over chargeless length (g/m)		20				20				20				
Note: “•” : Available															
Remarks for CU-4Z68TBE / CU-4Z80TBE / CU-5Z90TBE															
1. At least two indoor units must be connected.															
2. The total nominal cooling capacity of indoor unit that will be connected to outdoor unit must be within connectable capacity range of indoor unit. (as shown in the table above)															
Example: The indoor units' combination below is possible to connect to CU-4Z80TBE. (Total nominal capacity of indoor units is between 4.5kW to 14.7kW)															
1) Two CS-XZ25XKEW only. (Total nominal cooling capacity is 5.0kW)															

4. Features

- **Inverter Technology**
 - Wider output power range
 - Energy saving
 - Quick Cooling
 - Quick Heating
 - More precise temperature control
- **Environment Protection**
 - Non-ozone depletion substances refrigerant (R32)
- **Long Installation Piping**
 - Long piping up to 15 meters during single split connection only
- **Easy to use remote control**
- **Quality Improvement**
 - Random auto restart after power failure for safety restart operation
 - Gas leakage protection
 - Prevent compressor reverse cycle
 - Inner protector to protect compressor
 - Noise prevention during soft dry operation
- **Operation Improvement**
 - Quiet mode to reduce the indoor unit operating sound
 - Powerful mode to reach the desired room temperature quickly
 - 24-hour timer setting
 - nanoe™ X operation provides clean air, moisturises your skin and hair, deodorizes odours in the room
 - Mild Dry mode to improve humidity and moisture level during cooling operation
- **Serviceability Feature**
 - Activation and Deactivation Method for Heating Only Mode
 - Breakdown Self Diagnosis function
- **Communications network**

5. Location of Controls and Components

5.1 Indoor Unit

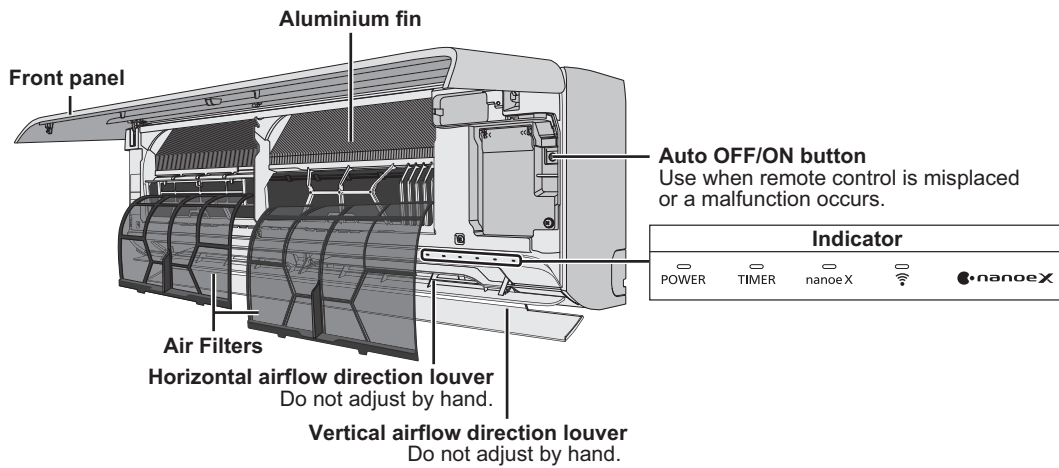

5.2 Outdoor Unit

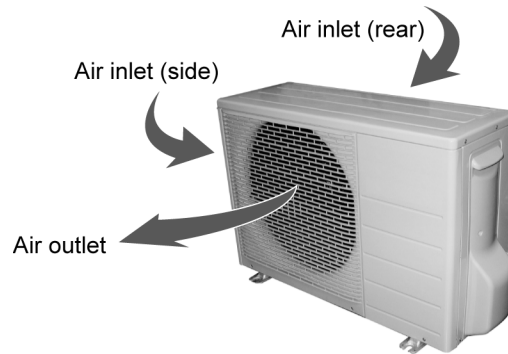

5.3 Remote Control

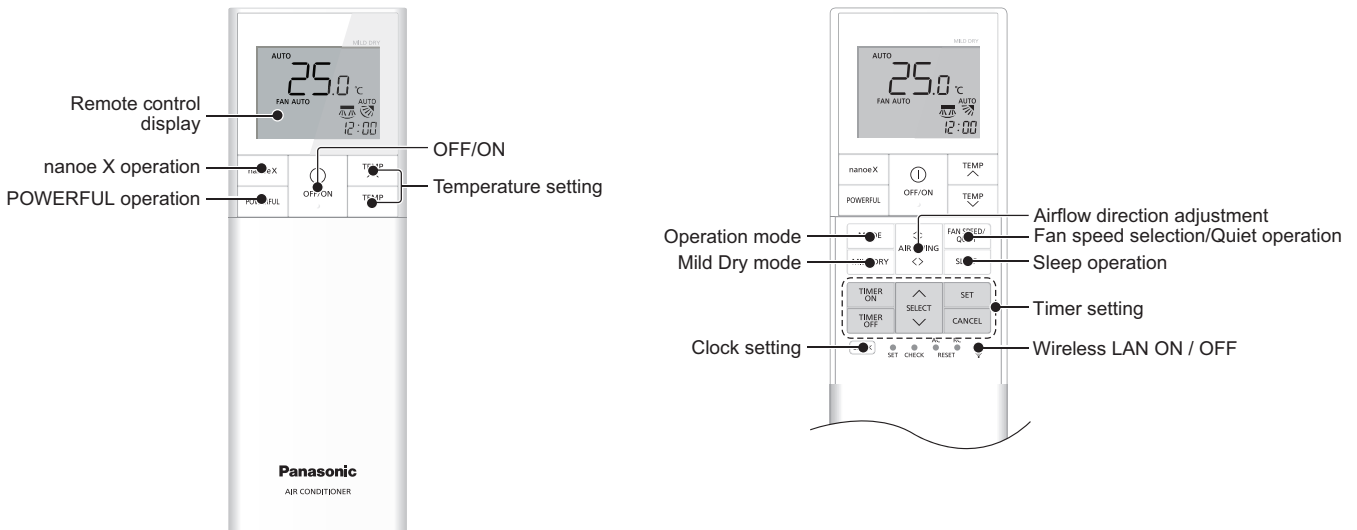

6. Dimensions

6.1 Indoor Unit

<Top View>

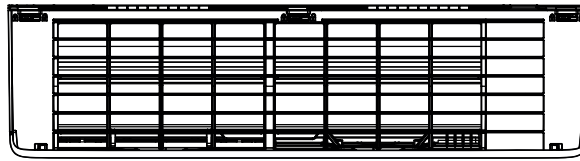

<Side View>

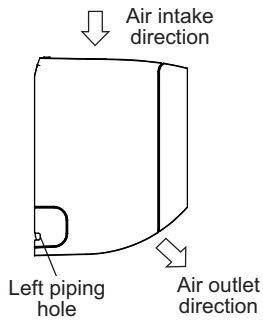

<Front View>

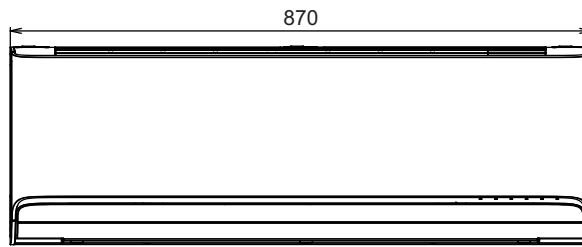

<Side View>

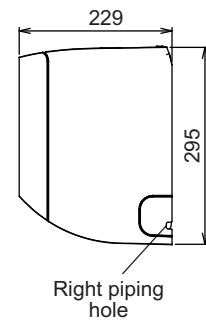

<Bottom View>

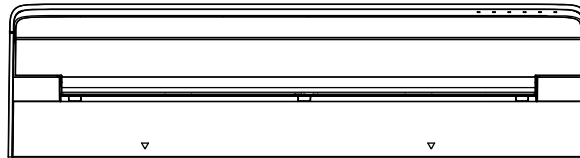

<Remote Control>

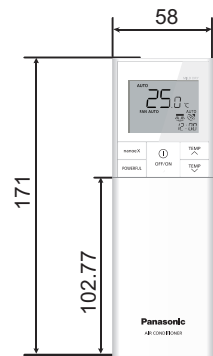

<Rear View>

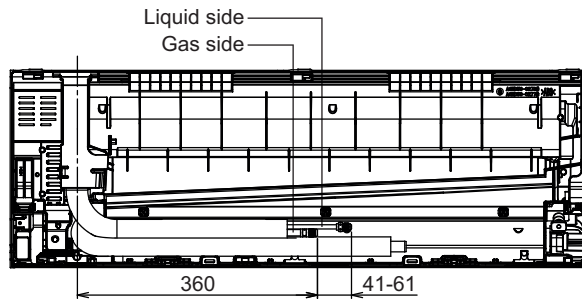

<Remote Control Holder>

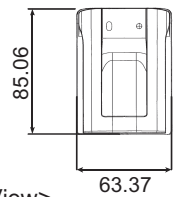

Relative position between the indoor unit and the installation plate <Front View>

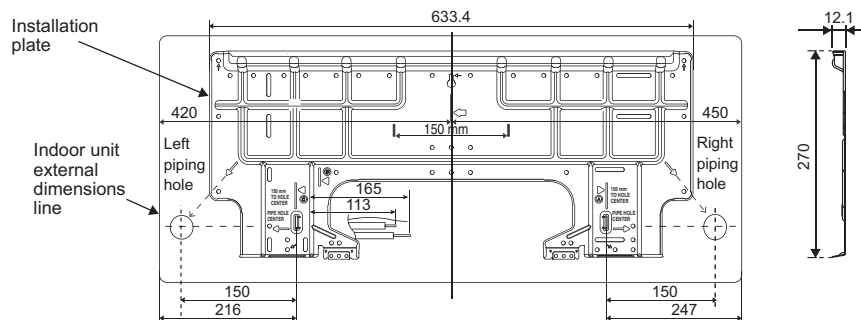

Unit: mm

6.2 Outdoor Unit

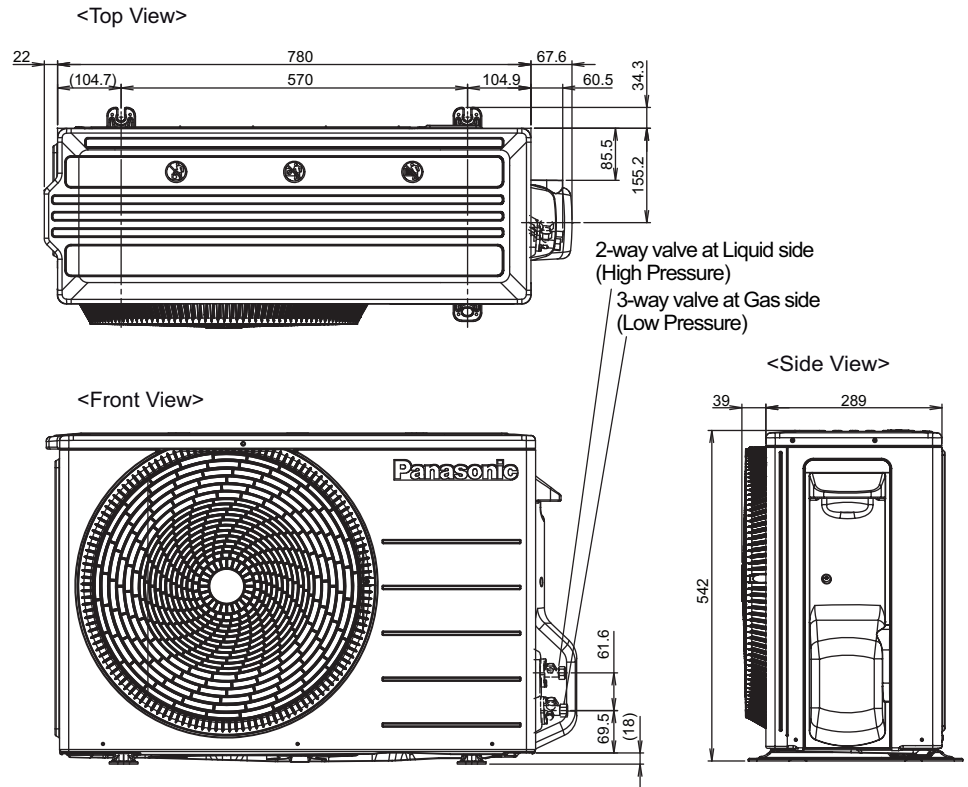
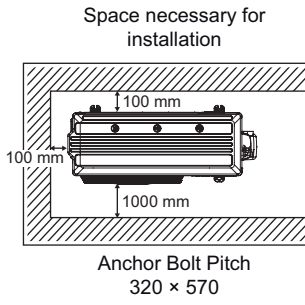

Unit: mm

7. Refrigeration Cycle Diagram

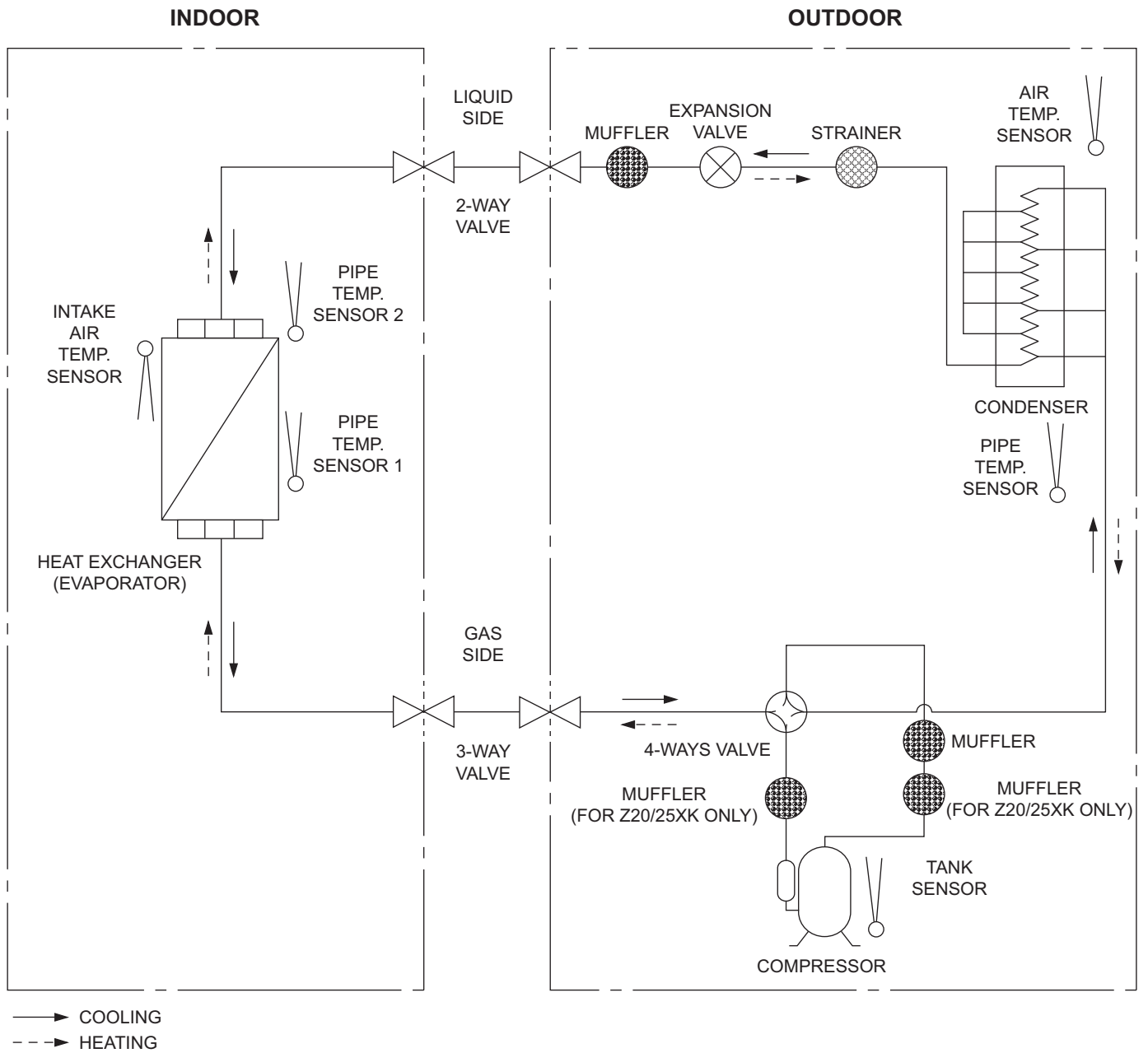

8. Block Diagram

8.1 CS-Z20XKEW CU-Z20XKE CS-Z25XKEW CU-Z25XKE CS-XZ20XKEW CU-Z20XKE CS-XZ25XKEW CU-Z25XKE

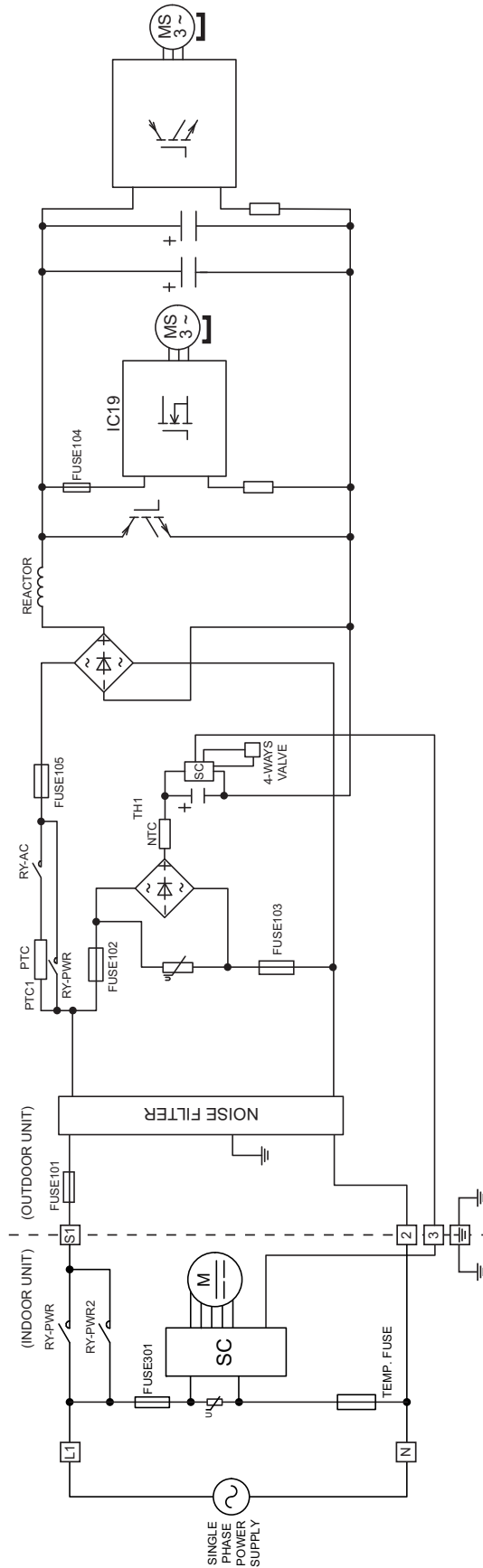

**8.2 CS-Z35XKEW CU-Z35XKE CS-Z42XKEW CU-Z42XKE
CS-XZ35XKEW CU-Z35XKE**

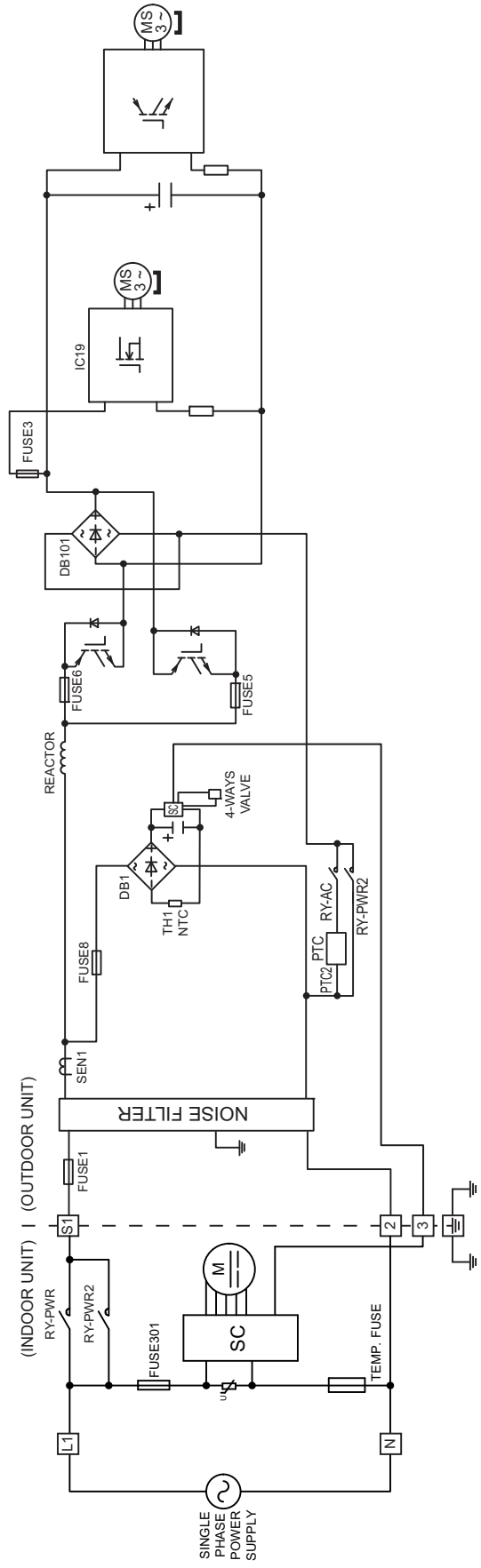

9. Wiring Connection Diagram

9.1 Indoor Unit

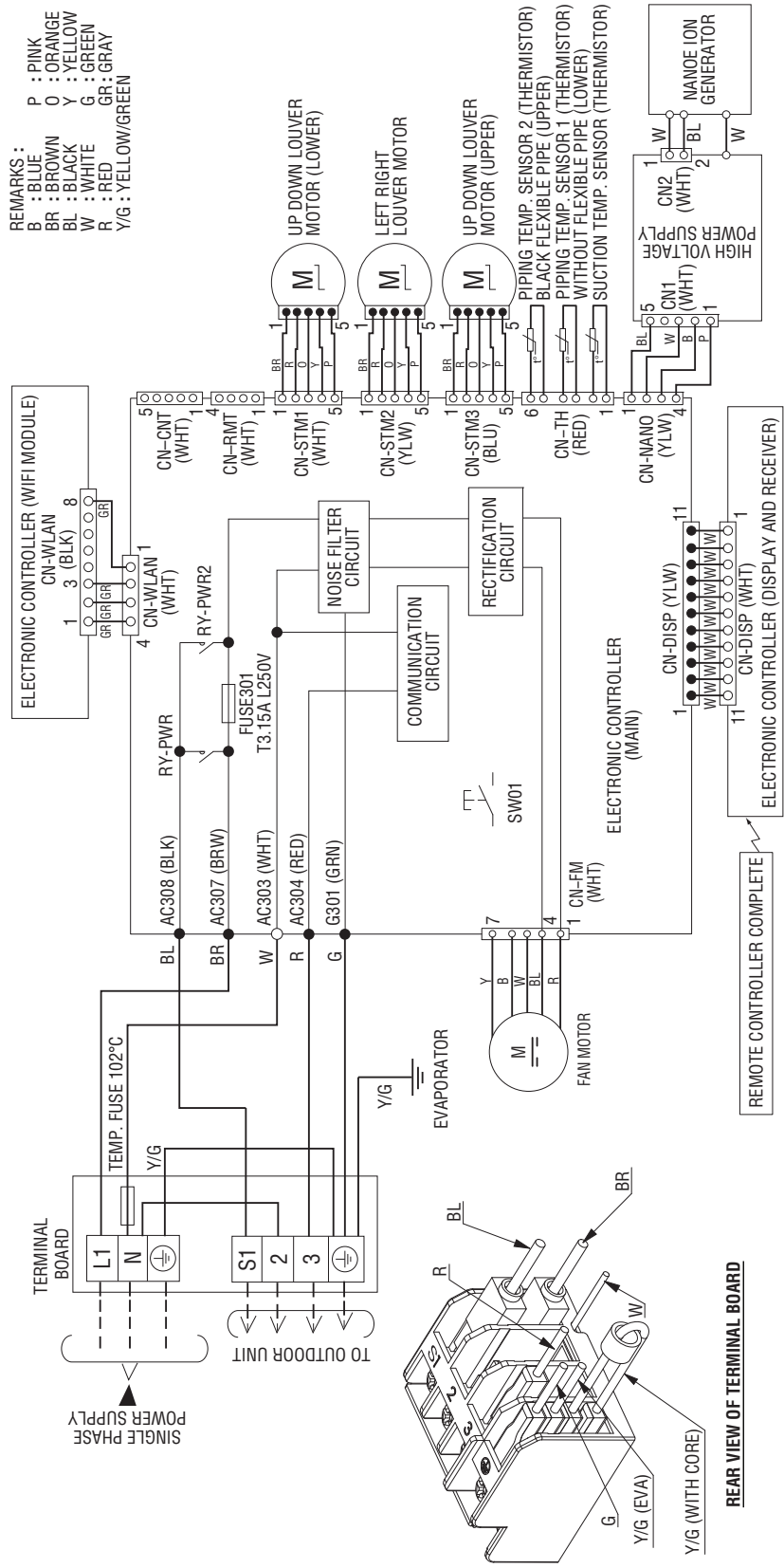

9.2 Outdoor Unit

9.2.1 CU-Z20XKE CU-Z25XKE

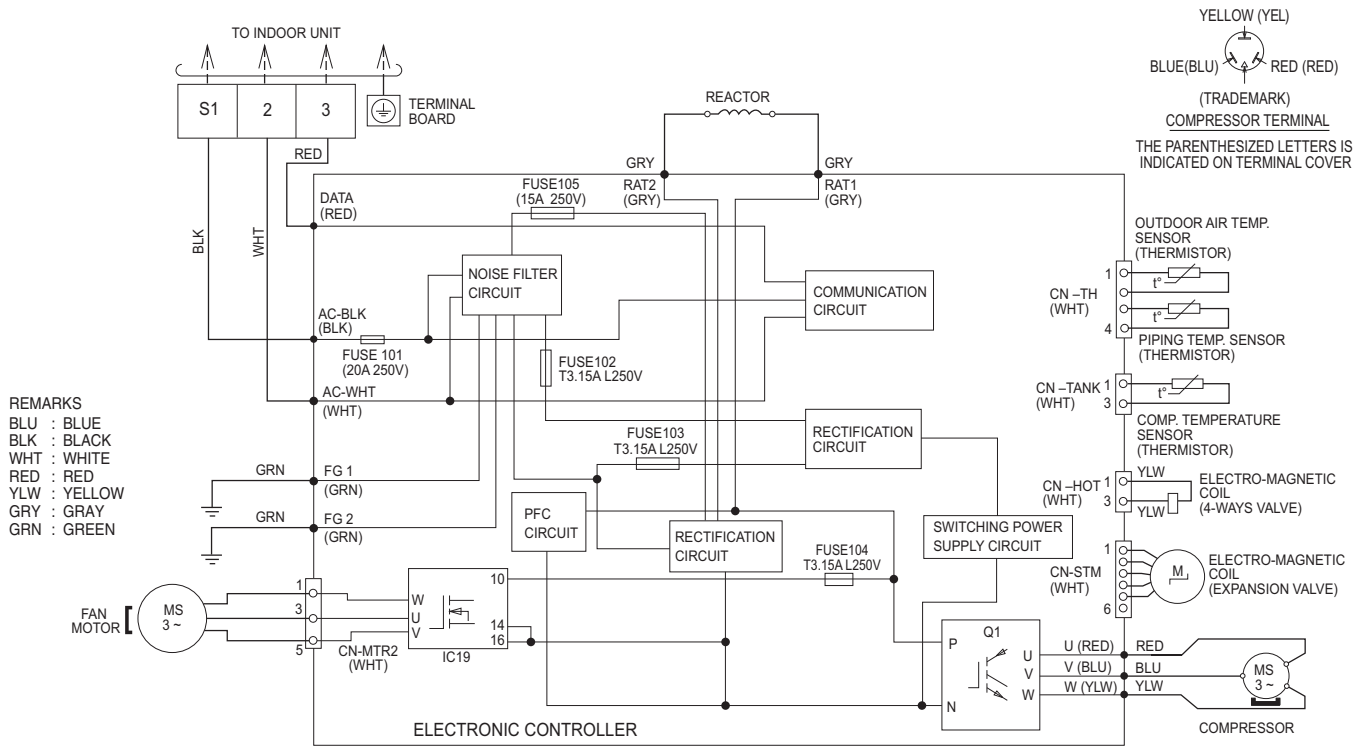

Resistance of Compressor Windings

MODEL	CU-Z20XKE / CU-Z25XKE
CONNECTION	9GS075XAA21 (Ω)
U-V	2.993
U-W	2.993
V-W	2.993

Note: Resistance at 20°C of ambient temperature.

9.2.2 CU-Z35XKE CU-Z42XKE

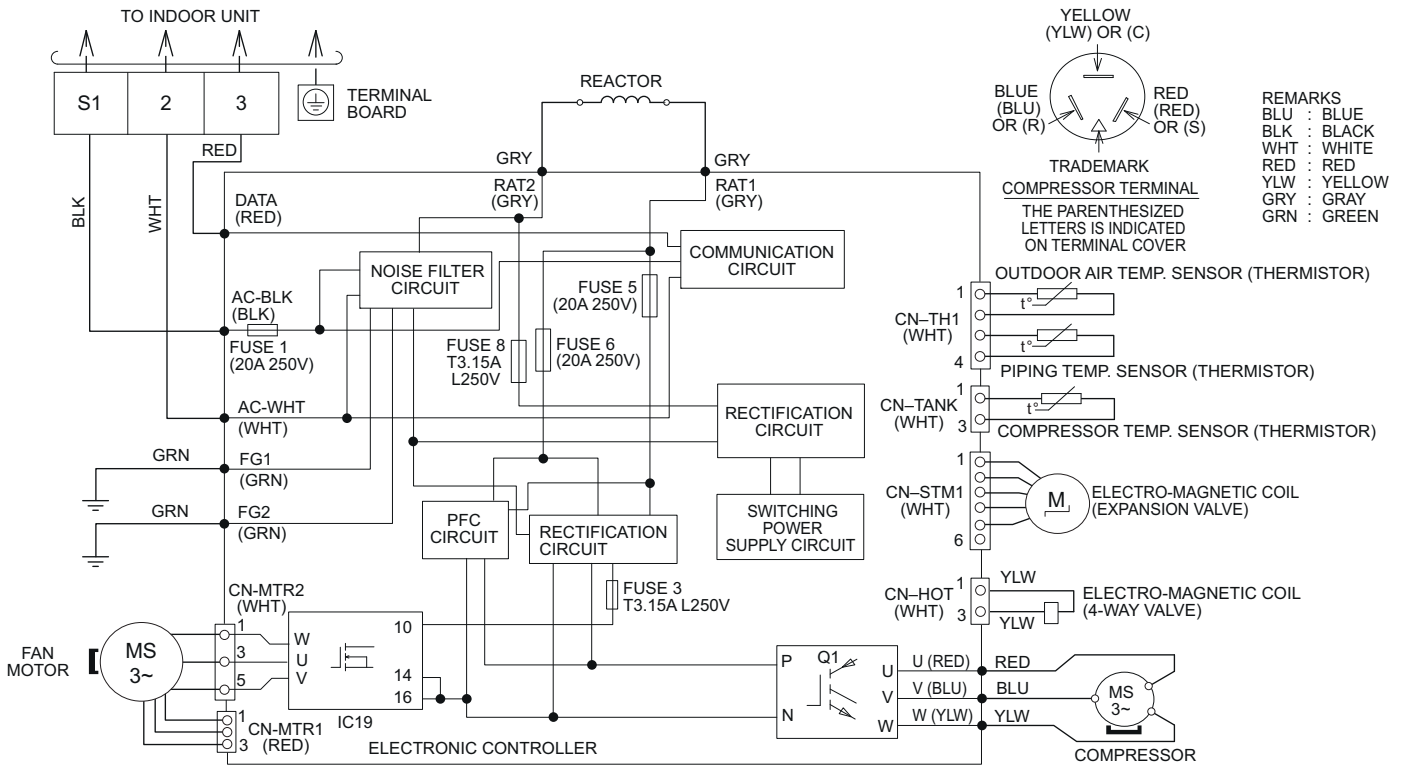

Resistance of Compressor Windings

MODEL	CU-Z35XKE / CU-Z42XKE
CONNECTION	9RS102XRA21 (Ω)
U-V	2.389
U-W	2.389
V-W	2.389

Note: Resistance at 20°C of ambient temperature.

10. Electronic Circuit Diagram

10.1 Indoor Unit

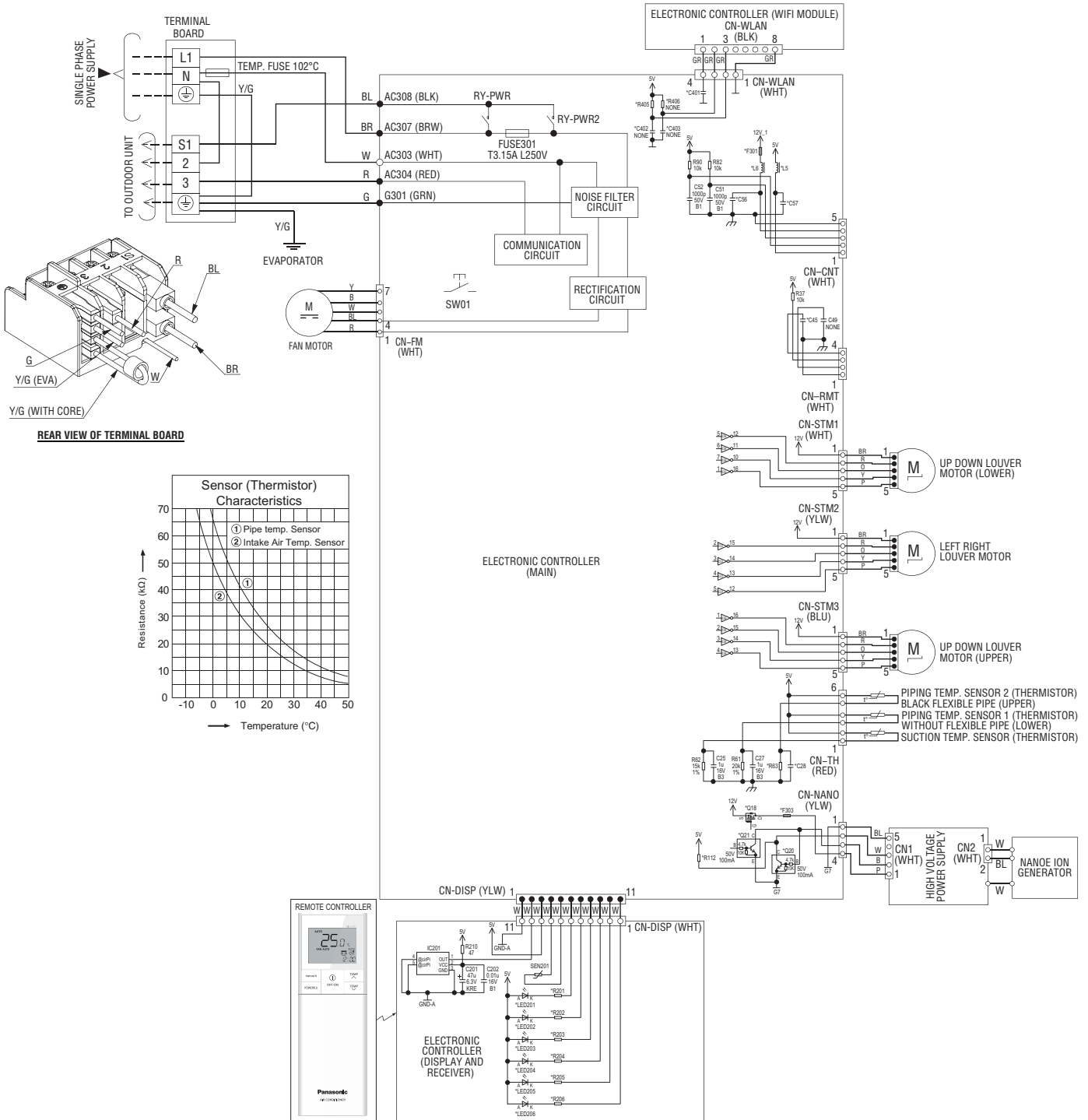

10.2 Outdoor Unit

10.2.1 CU-Z20XKE CU-Z25XKE

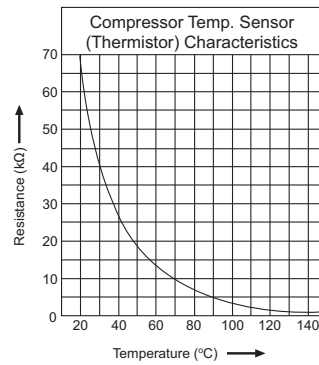
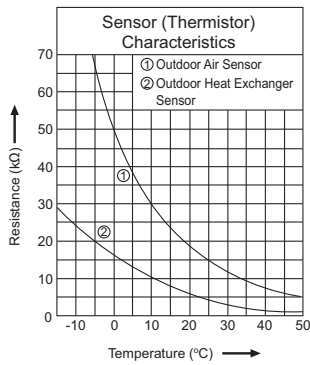
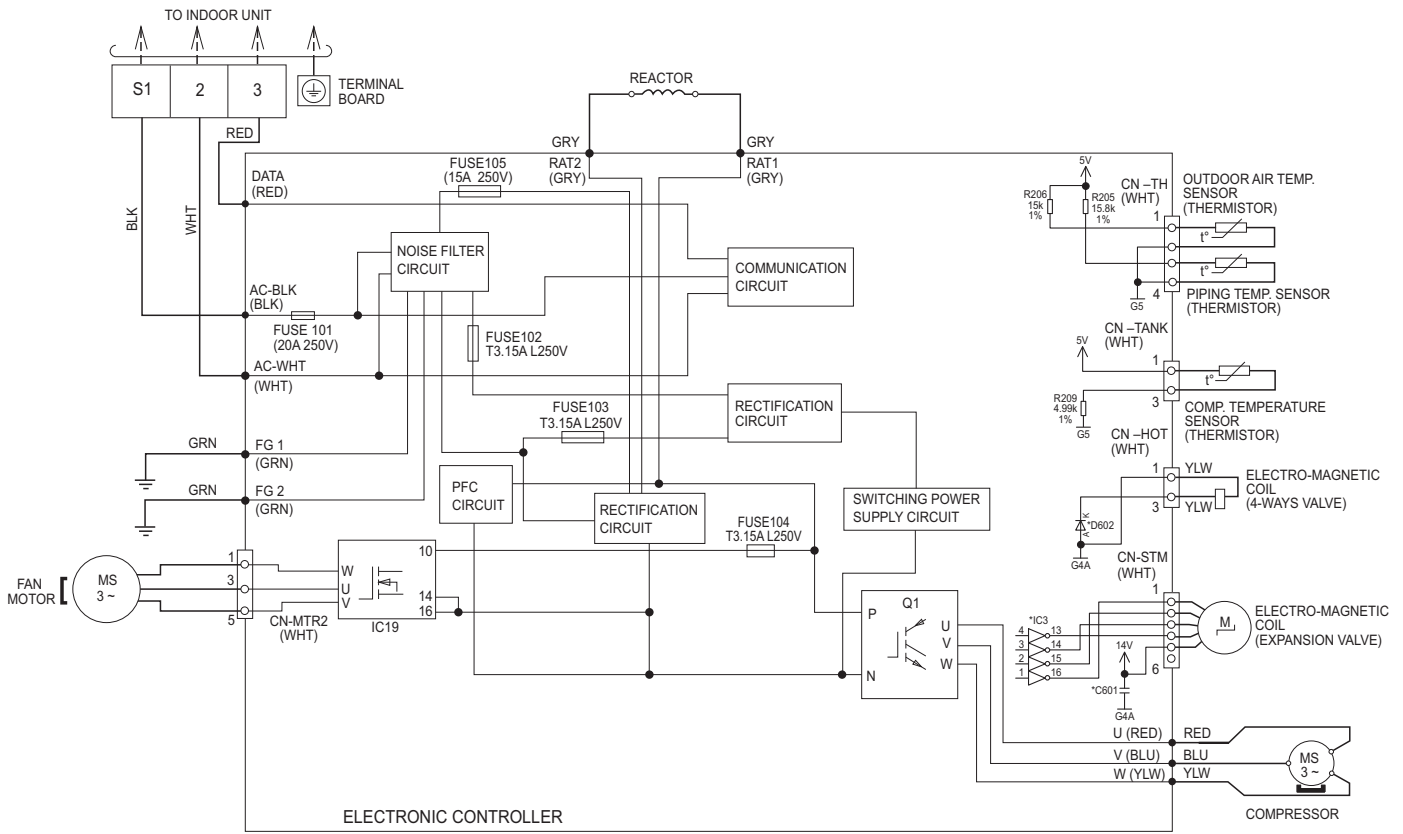

10.2.2 CU-Z35XKE CU-Z42XKE

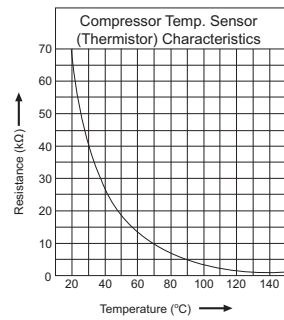
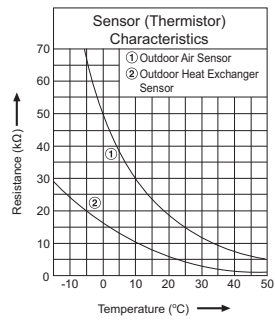
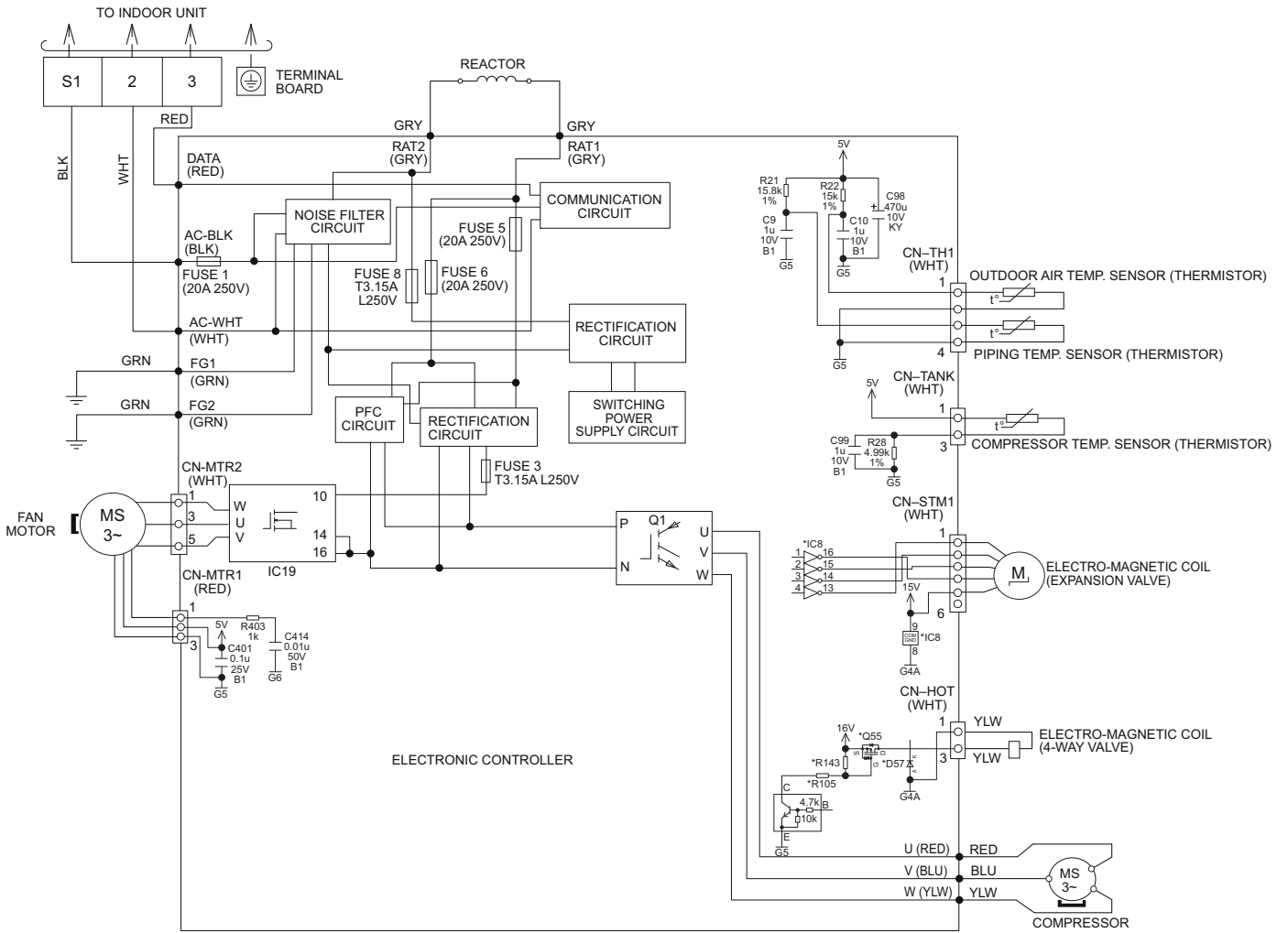

11. Printed Circuit Board

11.1 Indoor Unit

11.1.1 Main Printed Circuit Board

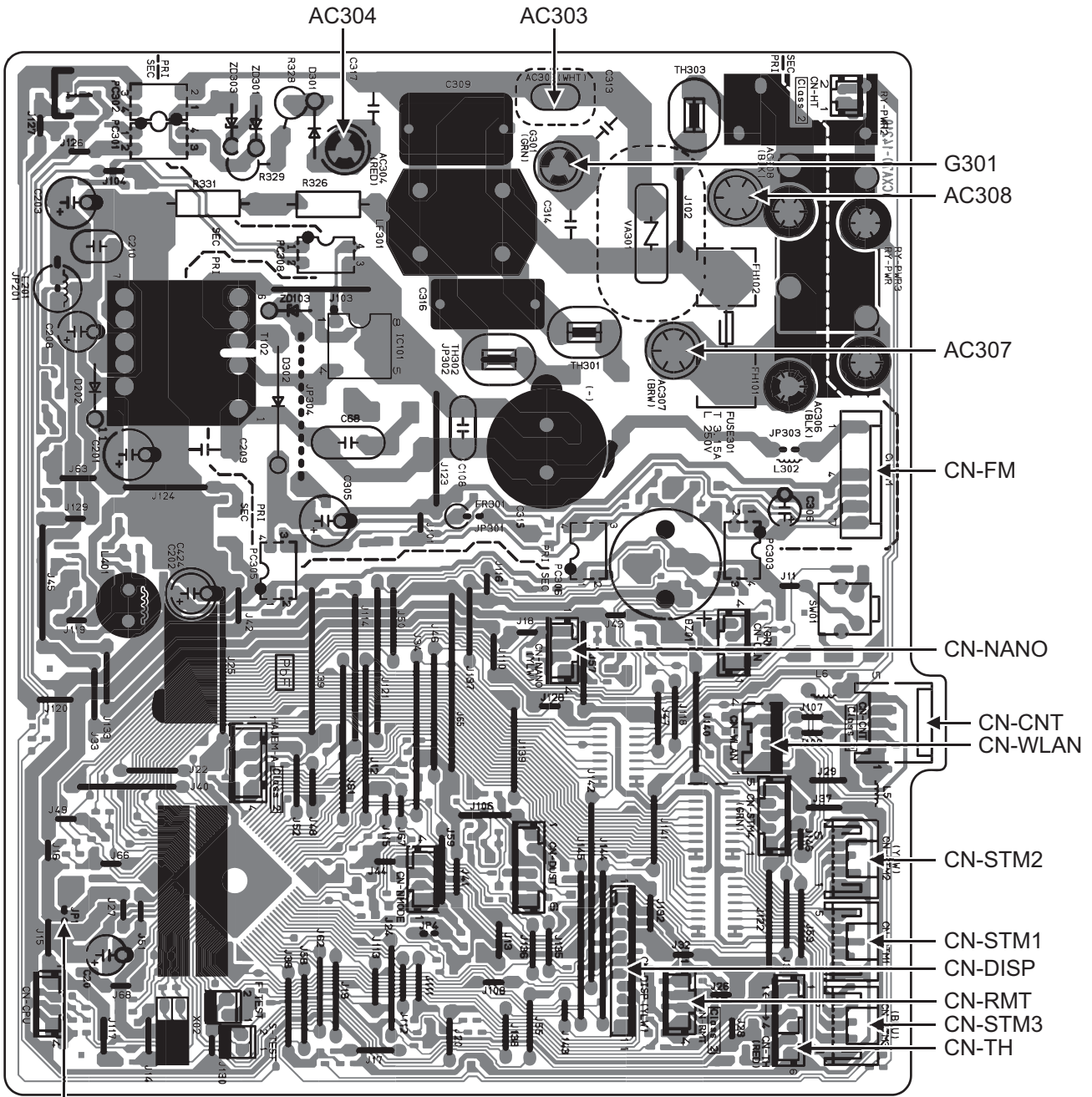

JP1 (Random Auto Restart enable/disable)

11.1.2 Indicator Printed Circuit Board

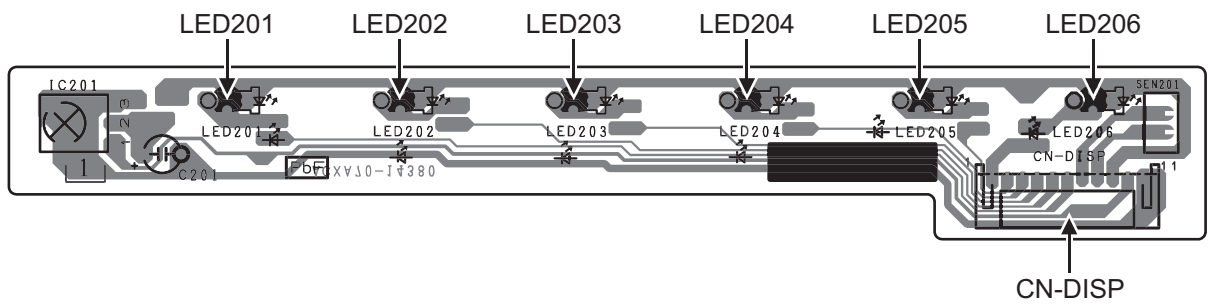

11.1.3 nanoeX

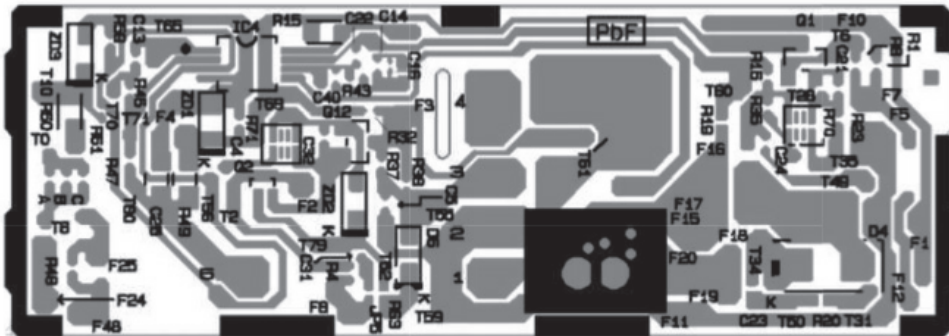

11.1.4 Wireless LAN Module Printed Circuit Board (Network Adapter)

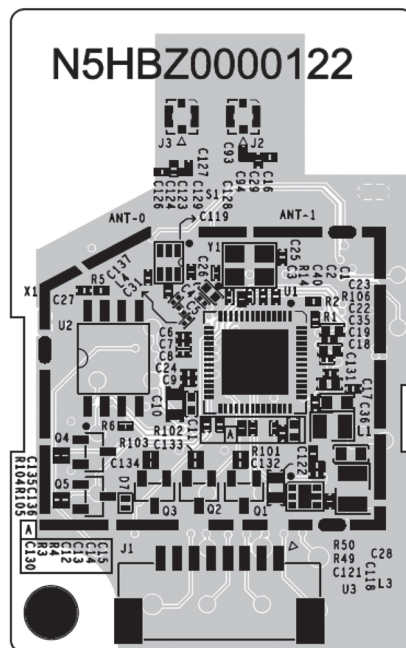

11.2 Outdoor Unit

11.2.1 Main Printed Circuit Board

11.2.1.1 CU-Z20XKE CU-Z25XKE

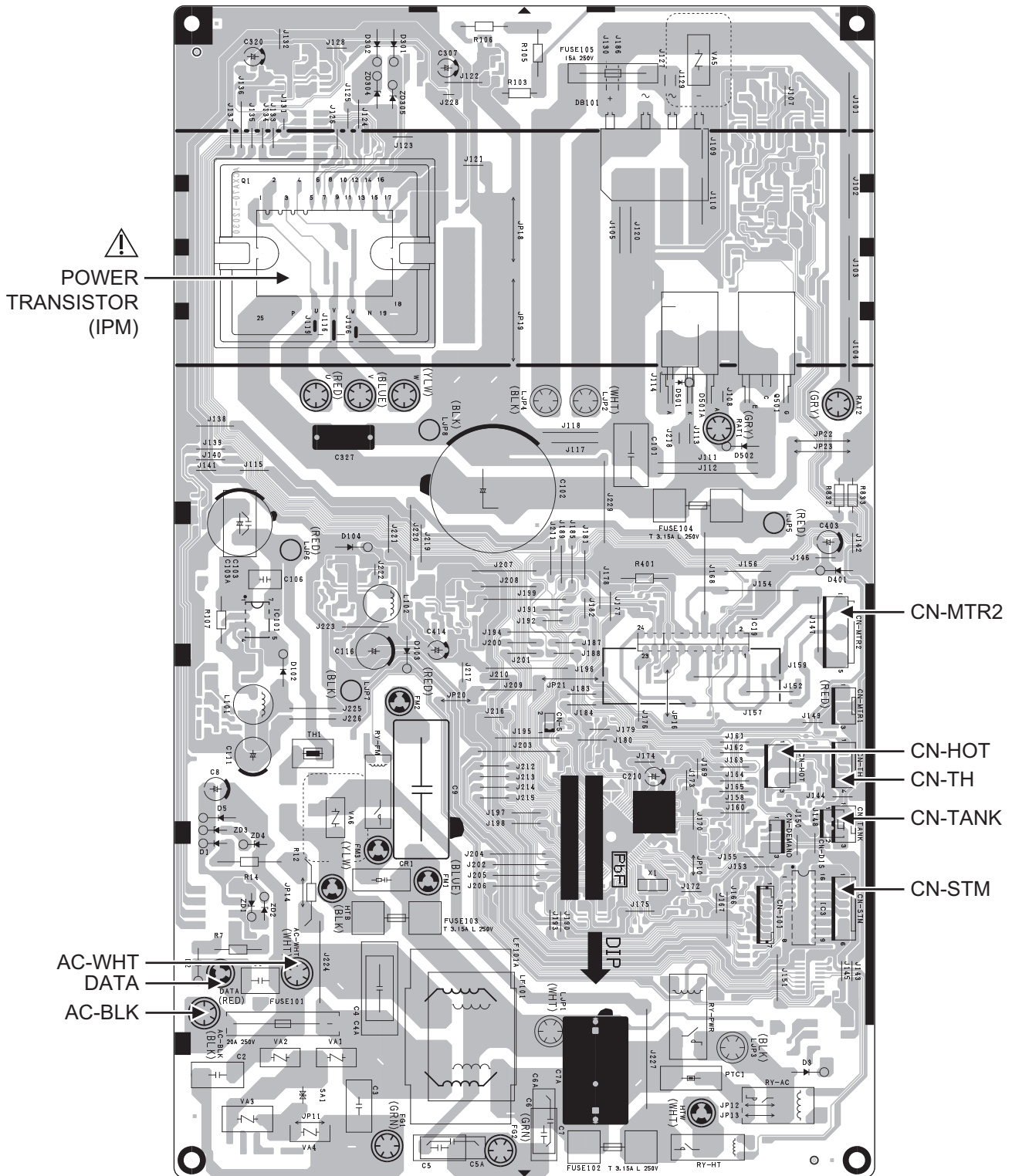

11.2.1.2 CU-Z35XKE CU-Z42XKE

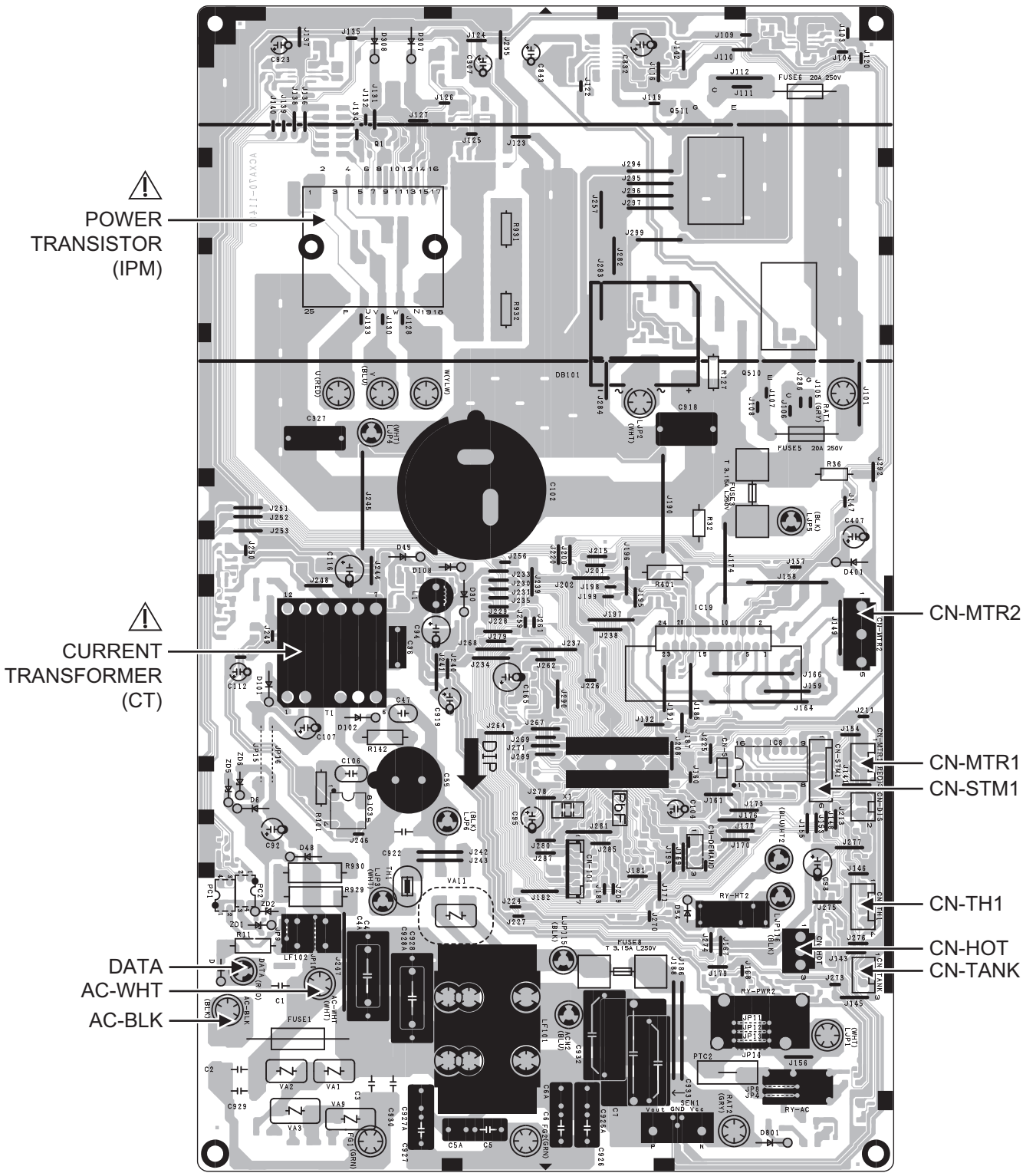

12. Installation Instruction

12.1 Select the Best Location

12.1.1 Indoor Unit

- Do not install the unit in excessive oil fume area such as kitchen, workshop and etc.
- There should not be any heat source or steam near the unit.
- There should not be any obstacles blocking the air circulation.
- A place where air circulation in the room is good.
- A place where drainage can be easily done.
- A place where noise prevention is taken into consideration.
- Do not install the unit near the door way.
- Ensure the spaces indicated by arrows from the wall, ceiling, fence or other obstacles.
- Indoor unit of this air conditioner shall be installed in a height of at least 1.8 m.

Table A

Model	Capacity W (HP)	Max. Refrigerant Charge (kg)	Indoor A_{min} (m ²)
Z20***, XZ20***	3/4HP	0.75	Not applicable (*)
Z25***, XZ25***	1.0HP	0.88	Not applicable (*)
Z35***, XZ35***	1.5HP	0.97	Not applicable (*)
Z42***	1.75HP	1.03	Not applicable (*)
Z50***, XZ50***	2.0HP	1.47	Not applicable (*)
Z71***	2.5HP	1.85	4.46

(*) Systems with total refrigerant charge, m_c , lower than 1.84kg are not subjected to any room area requirements.

* Table "A" only applicable for single split connection.

* In case of connection to outdoor multi inverter, refer to installation manual at outdoor unit.

$$A_{min} = (m_c / (2.5 \times (LFL)^{5/4} \times h_0))^2$$

** not less than safety factor margin

- A_{min} = Required minimum room area, in m²
- m_c = Refrigerant charge in appliance, in kg
- LFL = Lower flammability limit (0.307 kg/m³)
- h_0 = Installation height of the appliance (1.8 m for wall mounted)
- SF = Safety factor with a value of 0.75

** The required minimum room area, A_{min} , shall also be governed by the safety factor margin formula below :

$$A_{min} = m_c / (SF \times LFL \times h_0)$$

The higher value shall be taken when determining the room area.

(*) If holder at the rear of chassis (Refer column "12.2.3 Indoor Unit Installation") need to be used to prop up the unit, this distance shall be 65 mm or more.

12.1.2 Indoor/Outdoor Unit Installation Diagram

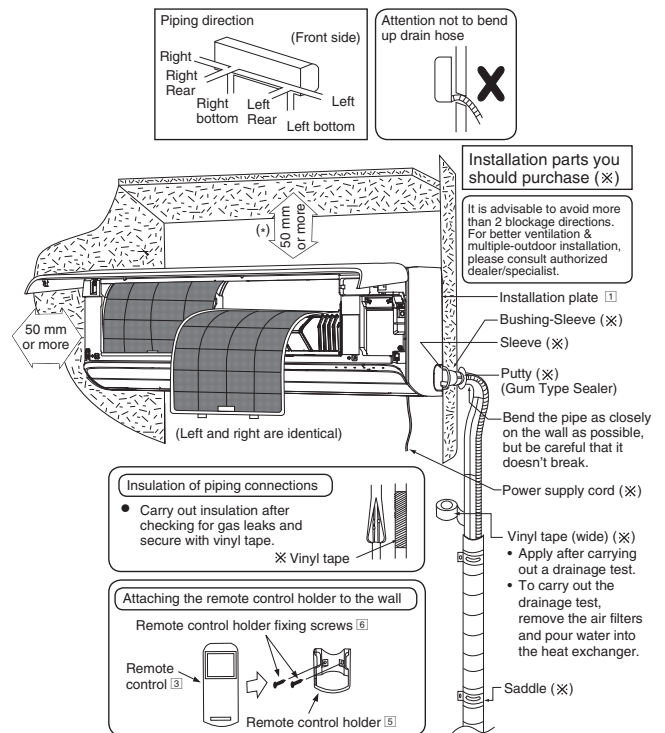

- This illustration is for explanation purposes only. The indoor unit will actually face a different way.

12.2 Indoor Unit

12.2.1 How to Fix Installation Plate

The mounting wall shall be strong and solid enough to prevent it from vibration.

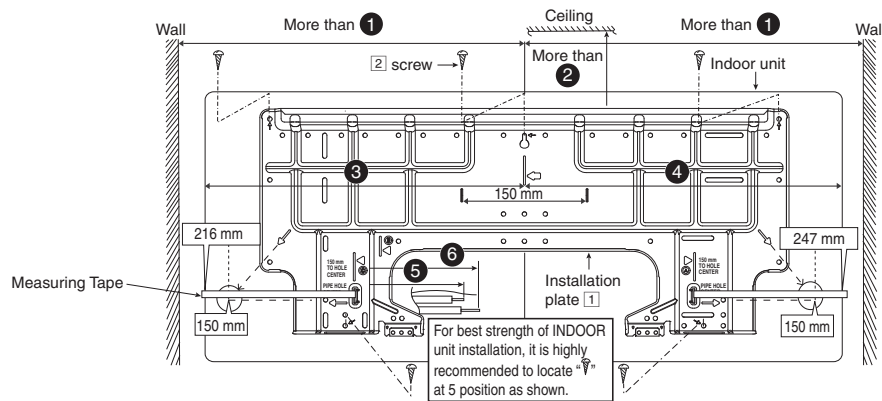

Model	Dimension					
	1	2	3	4	5	6
Z20***, Z25***, Z35***, Z42***, XZ20***, XZ25***, XZ35***	500 mm	70 mm (*)	420 mm	450 mm	113 mm	165 mm

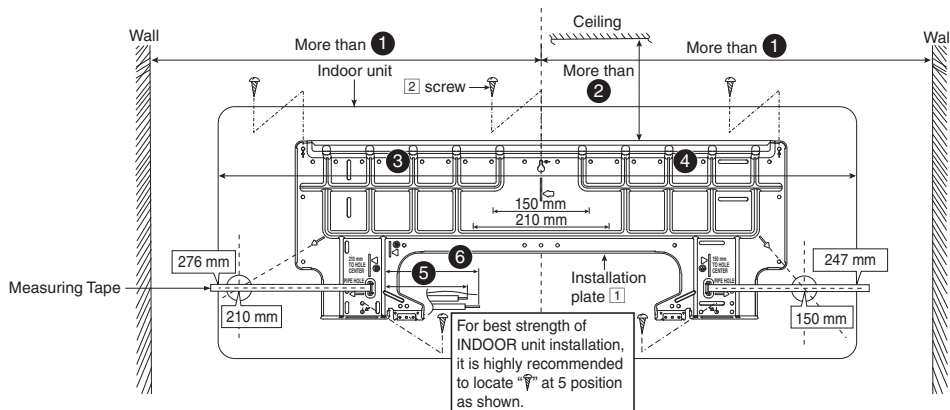

Model	Dimension					
	1	2	3	4	5	6
Z50***, Z71***, XZ50***	587 mm	70 mm (*)	537 mm	503 mm	226 mm	278 mm

The center of installation plate should be at more than ① at right and left of the wall.

The distance from installation plate edge to ceiling should more than ②.

From installation plate center to unit's left side is ③.

From installation plate center to unit's right side is ④.

- Ⓑ : For left side piping, piping connection for liquid should be about ⑤ from this line.
 : For left side piping, piping connection for gas should be about ⑥ from this line.

1 Mount the installation plate on the wall with 5 screws or more (at least 5 screws).
 (If mounting the unit on the concrete wall, consider using anchor bolts.)

- Always mount the installation plate horizontally by aligning the marking-off line with the thread and using a level gauge.
- 2 Drill the piping plate hole with $\varnothing 70$ mm hole-core drill.
 - Line according to the left and right side of the installation plate. The meeting point of the extended line is the center of the hole. Another method is by putting measuring tape at position as shown in the diagram above. The hole center is obtained by measuring the distance namely 150 mm for left and right hole respectively (Z20***, XZ20***, Z25***, XZ25***, Z35***, XZ35***, Z42***) or 210 mm for left hole and 150 mm for right hole (Z50***, XZ50***, Z71***).
 - Drill the piping hole at either the right or the left and the hole should be slightly slanting to the outdoor side.

Dimension ②

(*) :-
 If holder at the rear of chassis (Refer column "12.2.3 Indoor Unit Installation") need to be used to prop up the unit, this distance shall be 85 mm or more.

12.2.2 To Drill a Hole in the Wall and Install a Sleeve of Piping

- 1 Insert the piping sleeve to the hole.
- 2 Fix the bushing to the sleeve.
- 3 Cut the sleeve until it extrudes about 15 mm from the wall.

 **CAUTION**

 When the wall is hollow, please be sure to use the sleeve for tube assembly to prevent dangers caused by mice biting the connection cable.

- 4 Finish by sealing the sleeve with putty or caulking compound at the final stage.

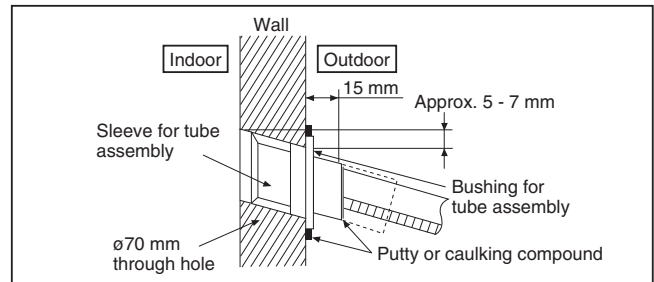

12.2.3 Indoor Unit Installation

Pull out the Indoor piping

- Do not turn over the unit without it's shock absorber during pull out the piping. It may cause intake grille damage.
- Use shock absorber during pull out the piping to protect the intake grille from damage.

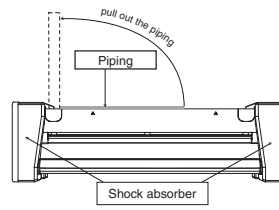
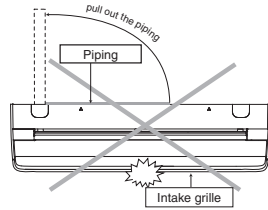

12.2.3.1 For the Right Rear Piping

- Step-1** Pull out the Indoor piping
- Step-2** Install the Indoor Unit
- Step-3** Secure the Indoor Unit
- Step-4** Insert the power supply cord and connection cable
- Insert the cables from bottom of the unit through the control board hole until terminal board area.

12.2.3.2 For the Right and Right Bottom Piping

- Step-1** Pull out the Indoor piping
- Step-2** Install the Indoor Unit
- Step-3** Insert the power supply cord and connection cable
- Insert the cables from bottom of the unit through the control board hole until terminal board area.
- Step-4** Secure the Indoor Unit

12.2.3.3 For the Embedded Piping

- Step-1** Change the drain hose position
- Step-2** Bend the embedded piping
- Use a spring bender or equivalent to bend the piping so that the piping is not crushed.
- Step-3** Pull the connection cable into Indoor Unit
- The power supply cord and indoor unit and outdoor unit connection cable can be connected without removing the front grille.
- Step-4** Cut and flare the embedded piping
- When determining the dimensions of the piping, slide the unit all the way to the left on the installation plate.
 - Refer to the column "Cutting and flaring the piping".
- Step-5** Install the Indoor Unit
- Step-6** Connect the piping
- Please refer to "Connecting the piping" column in outdoor unit section. (Below steps are done after connecting the outdoor piping and gas-leakage confirmation.)
- Step-7** Insulate and finish the piping
- Please refer to "Insulation of piping connection" column as mentioned in indoor/outdoor unit installation.
- Step-8** Secure the Indoor Unit

- Fasten the chassis to the installation plate with screws (Self purchase, Screw size: M4, max. length 10mm) to provide a neat appearance of indoor unit.

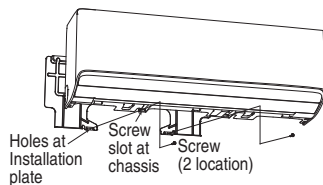

Right Rear piping

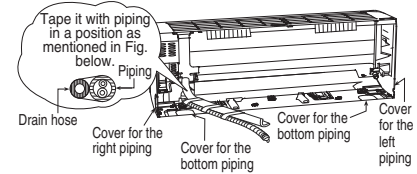

How to keep the cover

In case of the cover is cut, keep the cover at the rear of chassis as shown in the illustration for future reinstallation. (Left, right and 2 bottom covers for piping.)

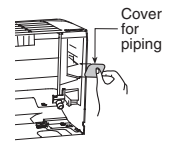

Right and Right bottom piping

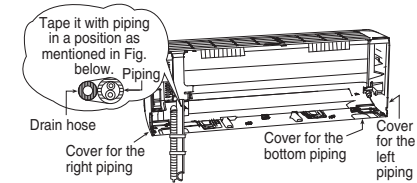

Install the indoor unit

Hook the indoor unit onto the upper portion of installation plate. (Engage the indoor unit with the upper edge of the installation plate). Ensure the hooks are properly seated on the installation plate by moving it in left and right.

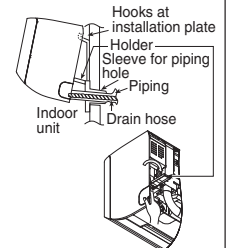

There is an option to use the holder at the rear of chassis to prop up the indoor unit as shown in the illustration for ease of installation. Push the holder back to original position before secure the indoor unit.

Alternatively, bottom plate of the indoor unit can be removed to enlarge the space for installation. Please refer column "How to take out front grille".

- Press the area of orange color to release holder.
- 1 holder (Z20***, XZ20***, Z25***, XZ25***, Z35***, XZ35***, Z42***) or 2 holder (Z50***, XZ50***, Z71***)

Secure the Indoor Unit

Press the lower left and right side of the unit against the installation plate until hooks engages with their slot (sound click).

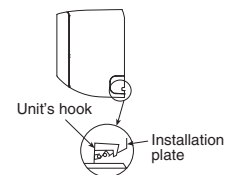

Insert the connection cable

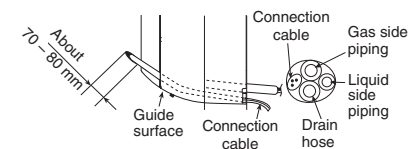

To take out the unit, push the ∇ marking at the bottom unit, and pull it slightly towards you to disengage the hooks from the unit.

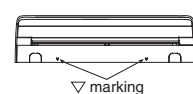

(This can be used for left rear piping also.)

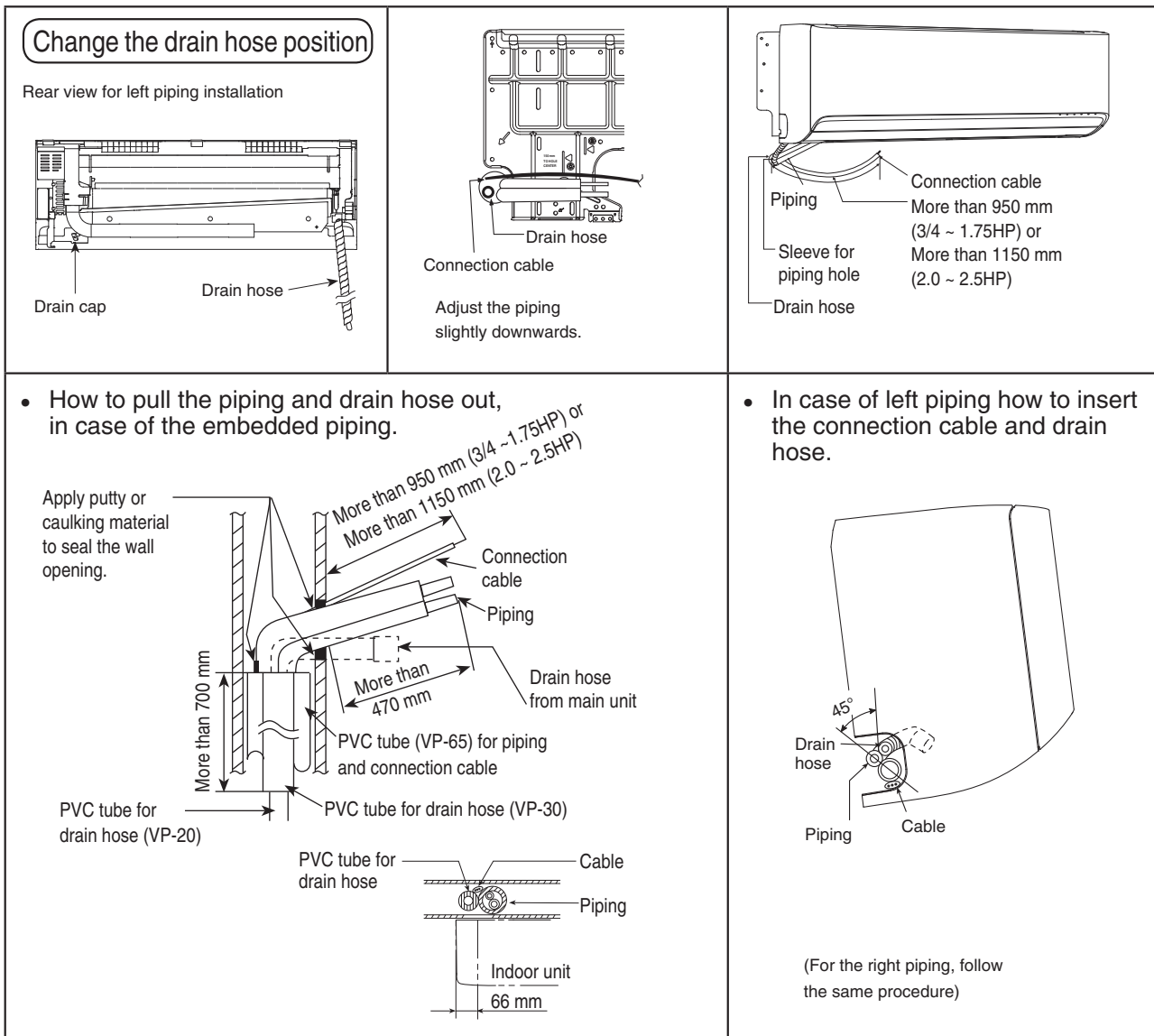

12.2.4 Connect the Cable to the Indoor Unit

The power supply cord, indoor and outdoor unit connection cable can be connected without removing the front grille.

- 1 Install the indoor unit on the installing holder that mounted on the wall.
- 2 Open the front panel and grille door by loosening the screw.
- 3 Cable connection to the power supply through Isolating Devices (Disconnecting means).
 - Connect the approved polychloroprene sheathed **power supply cord** $3 \times 1.5 \text{ mm}^2$ (3/4 ~ 1.75HP) or $3 \times 2.5 \text{ mm}^2$ (2.0 ~ 2.5HP), type designation 60245 IEC 57 or heavier cord to the terminal board, and connect the other end of the cable to Isolating Devices (Disconnecting means).
 - Do not use joint power supply cord. Replace the wire if the existing wire (from concealed wiring, or otherwise) is too short.
 - In unavoidable case, joining of power supply cord between isolating devices and terminal board of air conditioner shall be done socket and plug rated 15/16A (3/4 ~ 1.75HP) or 16A (2.0HP) or 20A (2.5HP). Wiring work to both socket and plug must follow to national wiring standard.
- 4 Bind all the **power supply cord** lead wire with tape and route the power supply cord via the left side escapement.
- 5 **Connection cable** between indoor unit and outdoor unit shall be approved polychloroprene sheathed $4 \times 1.5 \text{ mm}^2$ (3/4 ~ 1.75HP) or $4 \times 2.5 \text{ mm}^2$ (2.0 ~ 2.5HP) flexible cord, type designation 60245 IEC 57 or heavier cord.
- 6 Bind all the indoor and outdoor **Connection cable** with tape and route the connection cable via the right side escapement.
- 7 Remove the tapes and connect the power supply cord and connection cable between indoor unit and outdoor unit according to the diagram below.

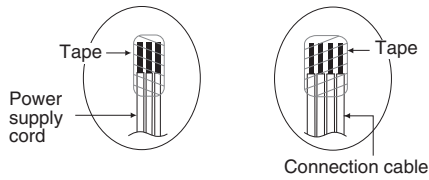

Terminals on the outdoor unit
Colour of wires (connection cable)
Terminals on the indoor unit (Power supply cord)
Terminals on the isolating devices (Disconnecting means)

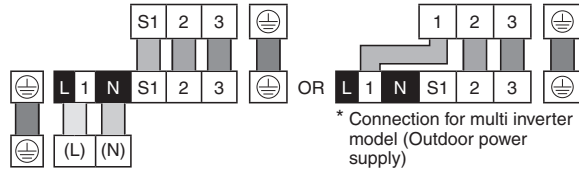

Recommended length (mm) refer table below

⚠ WARNING

This equipment must be properly earthed.

Recommended length (mm)	a	b	c	d	e	f	g
	30	30	60	45	40	35	55

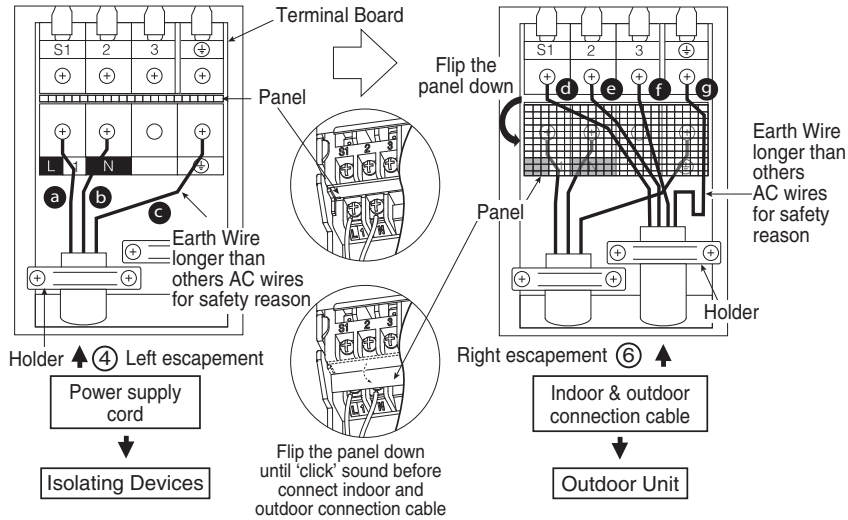

- 8 Secure firmly the power supply cord and connecting cable onto the control board with the holder. Do not overtighten holder screw, as this may damage the holder.
- 9 Close grille door by tighten with screw and close the front panel.

Note:

- Isolating Devices (Disconnecting means) should have minimum 3.0 mm contact gap.
- Ensure the colour of wires of outdoor unit and the terminal Nos. are the same to the indoor's respectively.
- Earth wire shall be Yellow/Green (Y/G) in colour and longer than other AC wires as shown in the figure for the electrical safety in case of the slipping out of the cord from the anchorage.

12.2.4.1 Wire Stripping Connecting and Requirement

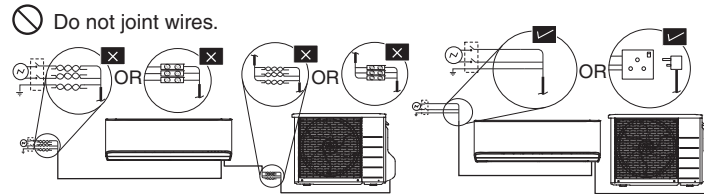
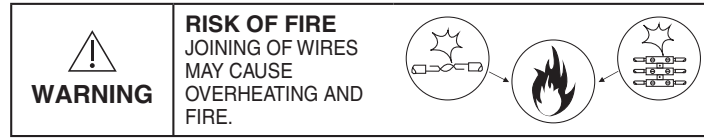
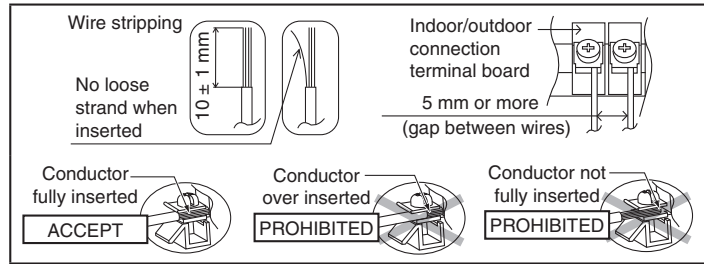

- ❗ Use complete wire without joining.
- ❗ Use approved socket and plug with earth pin.
- ❗ Wire connection in this area must follow to national wiring rules.

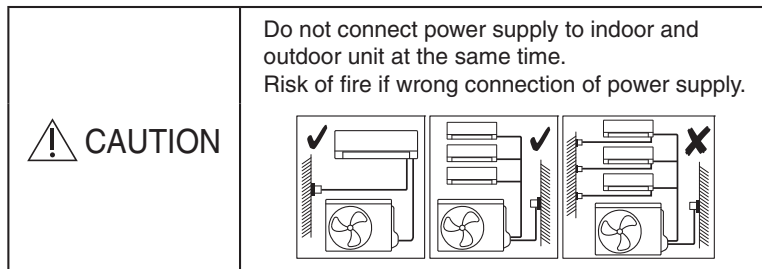

12.2.5 Connect the Piping

12.2.5.1 Connecting the Piping to Indoor

For connection joint of all model

Please make flare after inserting flare nut (locate at joint portion of tube assembly) onto the copper pipe. (In case of using long piping)

Connect the piping

- Align the center of piping and sufficiently tighten the flare nut with fingers.
- Further tighten the flare nut with torque wrench in specified torque as stated in the table.

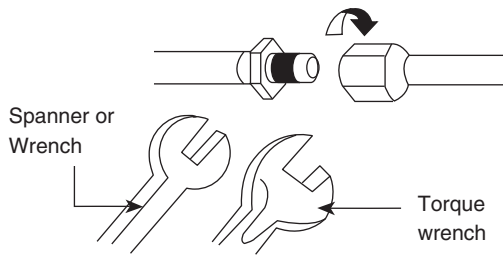

Additional Precautions For R32 Models when connecting by flaring at indoor side

⚠ Ensure to do the re-flaring of pipes before connecting to units to avoid leaking.

Seal sufficiently the flare nut (both gas and liquid sides) with neutral cure (Alkoxy type) & ammonia-free silicone sealant and insulation material to avoid the gas leak caused by freezing.

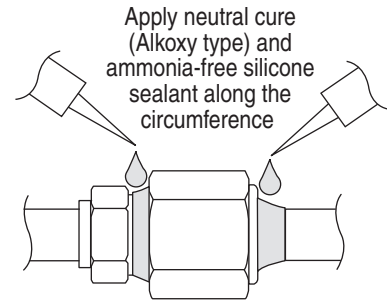

Neutral cure (Alkoxy type) & ammonia-free silicone sealant is only to be applied after pressure testing and cleaning up by following instructions of sealant, only to the outside of the connection. The aim is to prevent moisture from entering the connection joint and possible occurrence of freezing. Curing sealant will take some time. Make sure sealant will not peel off when wrapping the insulation.

12.2.5.2 Connecting the Piping to Outdoor

Decide piping length and then cut by using pipe cutter. Remove burrs from cut edge.

Make flare after inserting the flare nut (locate at valve) onto the copper pipe. Align center of piping to valve and then tighten with torque wrench to the specified torque as stated in the table.

⚠ Do not overtighten, overtightening may cause gas leakage.

Piping size	Torque
6.35 mm (1/4")	[18 N•m (1.8 kgf•m)]
9.52 mm (3/8")	[42 N•m (4.3 kgf•m)]
12.7 mm (1/2")	[55 N•m (5.6 kgf•m)]
15.88 mm (5/8")	[65 N•m (6.6 kgf•m)]
19.05 mm (3/4")	[100 N•m (10.2 kgf•m)]

12.2.5.3 Connecting the Piping to Outdoor Multi

Decide piping length and then cut by using pipe cutter. Remove burrs from cut edge. Make flare after inserting the flare nut (locate at valve) onto the copper pipe. Align center of piping to valve and then tighten with torque wrench to the specified torque as stated in the table.

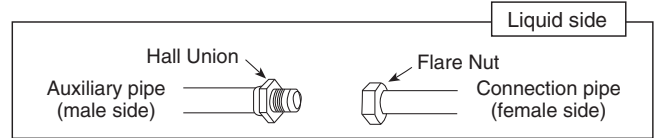

* For Gas side piping please refer table and diagram below

Outdoor Multi Combination Model		Pipe size (refer to diagram)
R32 Model		
CS-Z20*** CS-XZ20*** CS-Z25*** CS-XZ25*** CS-Z35*** CS-XZ35***	CU-2Z35*** CU-2Z41*** CU-2Z50*** CU-3Z52*** CU-3Z68*** CU-4Z68*** CU-4Z80*** CU-5Z90***	①
CS-Z42*** CS-Z50*** CS-XZ50***	CU-2Z50*** CU-3Z52*** CU-3Z68*** CU-4Z68*** CU-4Z80*** CU-5Z90***	② (CZ-MA1P)
CS-Z71***	CU-4Z80*** CU-5Z90***	③ (CZ-MA2P) & (CZ-MA3P)

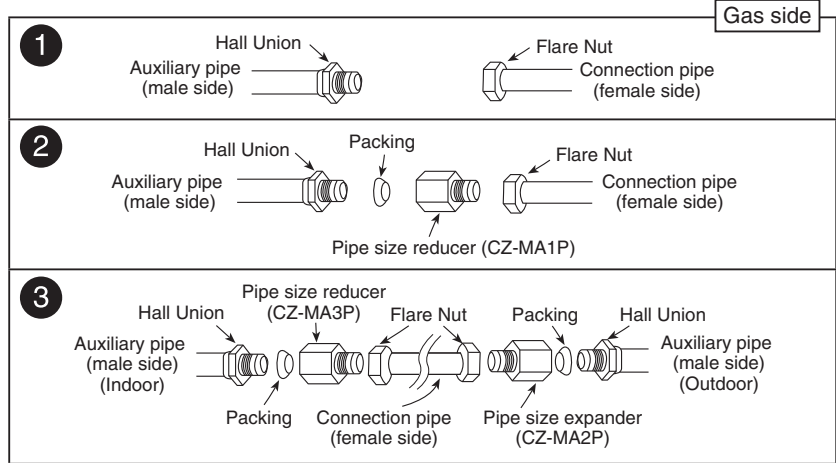

12.2.5.4 Cutting and Flaring the Piping

- 1 Please cut using pipe cutter and then remove the burrs.
- 2 Remove the burrs by using reamer. If burrs is not removed, gas leakage may be caused. Turn the piping end down to avoid the metal powder entering the pipe.
- 3 Please make flare after inserting the flare nut onto the copper pipes.

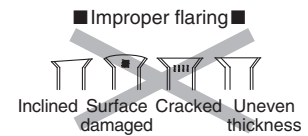
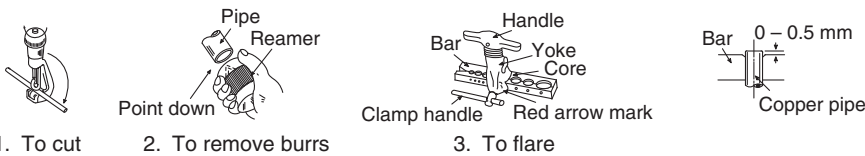

When properly flared, the internal surface of the flare will evenly shine and be of even thickness. Since the flare part comes into contact with the connections, carefully check the flare finish.

12.2.6 How to Take Out Front Grille

Please follow the steps below to take out front grille if necessary such as when installing or servicing.

Model	Z20***, Z25***, Z35***, Z42***, XZ20***, XZ25***, XZ35***
-------	--

- 1 Pull down 3 caps at the bottom, then remove 3 mounting screws.
- 2 Cling finger around screw area slot, pull the bottom plate downward until a click sound indicates hook is unleashed. Move the bottom plate forward carefully.
- 3 Open front panel.
- 4 Remove 3 mounting screws on the front grille.
- 5 Slide the 3 lock knobs on the upside of front grille to unlock position.
- 6 Set the upper vane to horizontal position. Set the lower vane to slightly below horizontal position.
- 7 Pull the front grille towards you to remove the front grille.

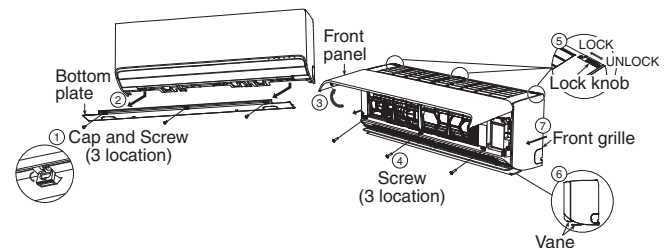

Upper vane: Set to horizontal;
Lower vane: Set to slightly below horizontal

Model	Z50***, Z71***, XZ50***
-------	-------------------------

- 1 Pull down 3 caps at the bottom, then remove 3 mounting screws.
- 2 Open front panel.
- 3 Remove 3 mounting screws on the front grille.
- 4 Slide the 4 lock knobs on the upside of front grille to unlock position
- 5 Pull the front grille towards you to remove the front grille.

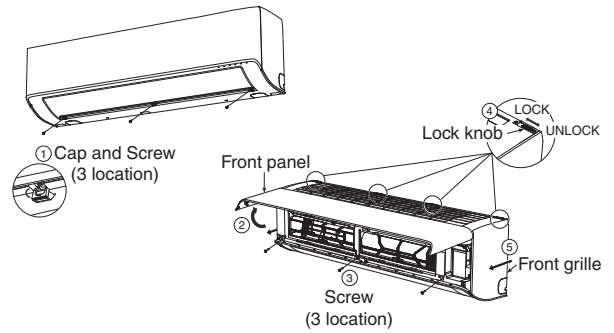

12.2.7 Auto Switch Operation

The below operations will be performed by pressing the “AUTO” switch.

- 1 **AUTO OPERATION MODE**
The Auto operation will be activated immediately once the Auto Switch is pressed and release within 5 sec..
- 2 **TEST RUN OPERATION (FOR PUMP DOWN/SERVICING PURPOSE)**
The Test Run operation will be activated if the Auto Switch is pressed continuously for more than 5 sec. to below 8 sec..
A “pep” sound will occur at the fifth sec., in order to identify the starting of Test Run operation.
- 3 **HEATING TRIAL OPERATION**
Press the “AUTO” switch continuously for more than 8 sec. to below 11 sec. and release when a “pep pep” sound is occurred at eight sec. (However, a “pep” sound is occurred at fifth sec..) Then press Remote controller “AC Reset” button once.
Remote controller signal will activate operation to force heating mode.
- 4 **REMOTE CONTROLLER RECEIVING SOUND ON/OFF**
The ON/OFF of Remote controller receiving sound can be change over by the following steps:
 - a) Press “AUTO” switch continuously for more than 16 sec. to below 21 sec..
A “pep”, “pep”, “pep”, “pep” sound will occur at the sixteenth sec..
 - b) Press the “AC Reset” button once, “pep” sound will occur indicates that Remote controller receiving sound setting mode is activated.
 - c) Press “AUTO” switch again. Everytime “AUTO” switch is pressed (within 60 sec. interval), Remote controller receiving sound status will be reversed between ON and OFF.
Long “peep” sound indicates that Remote controller receiving sound is ON.
Short “pep” sound indicates that Remote controller receiving sound is OFF.

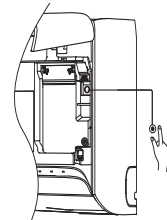

12.2.8 Heating Only Operation

- 1 Use remote controller to set heating only operation. When the unit in standby mode, follow the steps below:
 - a) Press continuously for more than 5 seconds to enter special setting mode.
 - b) Press to choose function 61, and then press or to set “01”.
 - c) Press to activate “Heating only operation”.

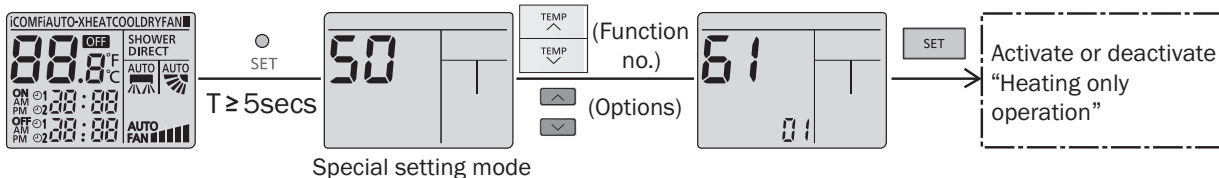

12.2.9 How to Replace Network Adapter

- Remove the front grille (refer how to take out front grille) from the unit.
- Remove the indicator piece by releasing the hook.
- Remove 1 mounting screw, then remove the network adaptor holder.
- After that, network adaptor can be easily replaced.

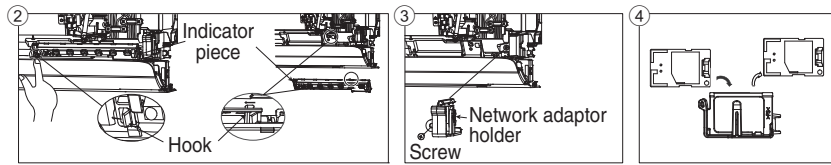

12.2.10 Check the Drainage

- Open front panel and remove air filters. (Drainage checking can be carried out without removing the front grille.)
- Pour a glass of water into the drain tray-styrofoam.
- Ensure that water flows out from drain hose of the indoor unit.

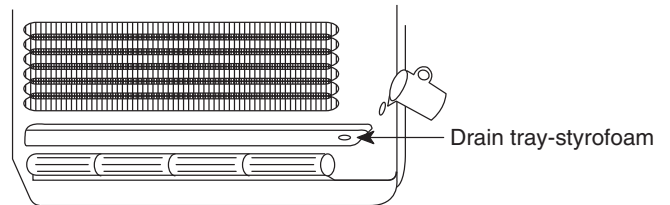

12.2.11 Evaluation of the Performance

- Operate the unit at cooling/heating operation mode for fifteen minutes or more.
- Measure the temperature of the intake and discharge air.
- Ensure the difference between the intake temperature and the discharge is more than 8°C during Cooling operation or more than 14°C during Heating operation.

Note:

- During extremely cold winter, turn on the power supply and standby the unit for at least 15 minutes before test run. Allow sufficient time to warm up refrigerant and prevent wrong error code judgement.

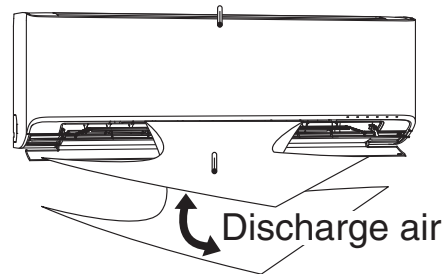

12.3 Select the Best Location

12.3.1 Outdoor Unit

- If an awning is built over the unit to prevent direct sunlight or rain, be careful that heat radiation from the condenser is not obstructed.
- There should not be any animal or plant which could be affected by hot air discharged.
- Keep the spaces indicated by arrows from wall, ceiling, fence or other obstacles.
- Do not place any obstacles which may cause a short circuit of the discharged air.
- If piping length is over the [piping length for additional gas], additional refrigerant should be added as shown in the table.

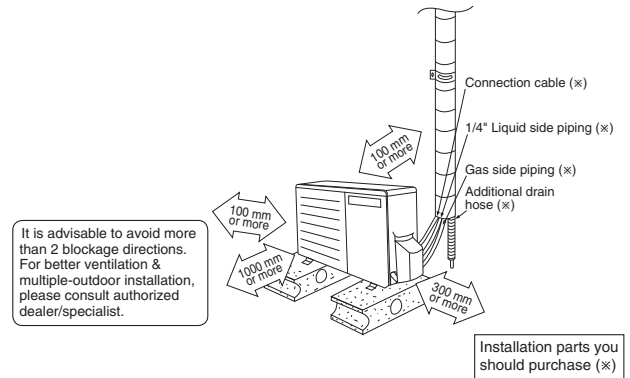

- This illustration is for explanation purposes only.

Table A

Model	Capacity W (HP)	Piping size		Std. Length (m)	Max Elevation (m)	Min. Piping Length (m)	Max. Piping Length (m)	Additional Refrigerant (g/m)	Piping Length for add. gas (m)	Max. Refrigerant Charge (kg)	Indoor A_{min} (m ²)	
		Gas	Liquid									
Z20***, XZ20***	3/4HP	9.52 mm (3/8")	6.35 mm (1/4")	5	15	3	15	10	7.5	0.75	Not applicable (*)	
Z25***, XZ25***	1.0HP				15	3	15	10	7.5	0.88	Not applicable (*)	
Z35***, XZ35***	1.5HP				15	3	15	10	7.5	0.97	Not applicable (*)	
Z42***	1.75HP				12.7 mm (1/2")	15	3	15	10	7.5	1.03	Not applicable (*)
Z50***, XZ50***	2.0HP				15	3	30	15	7.5	1.47	Not applicable (*)	
Z71***	2.5HP	15.88 mm (5/8")			20	3	30	25	10	1.85	4.46	

(*) Systems with total refrigerant charge, m_c lower than 1.84kg are not subjected to any room area requirements.

Example: For Z20***

If the unit is installed at 10 m distance, the quantity of additional refrigerant should be 25 g $(10-7.5) \text{ m} \times 10 \text{ g/m} = 25 \text{ g}$.

$$A_{min} = (m_c / (2.5 \times (LFL)^{(5/4)} \times h_0))^2 \quad \text{** not less than safety factor margin}$$

A_{min} = Required minimum room area, in m²

m_c = Refrigerant charge in appliance, in kg

LFL = Lower flammability limit (0.307 kg/m³)

h_0 = Installation height of the appliance (1.8 m for wall mounted)

SF = Safety factor with a value of 0.75

** The required minimum room area, A_{min} , shall also be governed by the safety factor margin formula below :

$$A_{min} = m_c / (SF \times LFL \times h_0)$$

The higher value shall be taken when determining the room area.

12.4 Outdoor Unit

12.4.1 Install the Outdoor Unit

- After selecting the best location, start installation to Indoor/Outdoor Unit Installation Diagram.
 - Fix the unit on concrete or rigid frame firmly and horizontally by bolt nut ($\phi 10$ mm).
Make sure unit install in balance level to ensure that water flow out from unit drainage hole.
 - When installing at roof, please consider strong wind and earthquake.
Please fasten the installation stand firmly with bolt or nails.

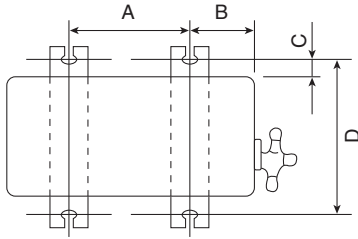

Model	A	B	C	D
Z20***, XZ20***	570 mm	105 mm	18.5 mm	320 mm
Z25***, XZ25***				
Z35***, XZ35***				
Z42***	613 mm	131 mm	24 mm	360.5 mm
Z50***, XZ50***				
Z71***				

12.4.2 Connect the Piping

12.4.2.1 Connecting the Piping to Indoor

For connection joint location at outside building
Please make flare after inserting flare nut (locate at joint portion of tube assembly) onto the copper pipe.
(In case of using long piping)

Connect the piping

- Align the center of piping and sufficiently tighten the flare nut with fingers.
- Further tighten the flare nut with torque wrench in specified torque as stated in the table.

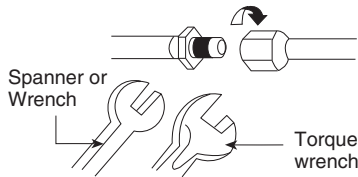

12.4.2.2 Connecting the Piping to Outdoor

Decide piping length and then cut by using pipe cutter.
Remove burrs from cut edge.

Make flare after inserting the flare nut (locate at valve) onto the copper pipe. Align center of piping to valve and then tighten with torque wrench to the specified torque as stated in the table.

For connection joint location at inside building

- Refer to indoor installation instruction.

⊘ Do not overtighten, overtightening may cause gas leakage	
Piping size	Torque
6.35 mm (1/4")	[18 N•m (1.8 kgf•m)]
9.52 mm (3/8")	[42 N•m (4.3 kgf•m)]
12.7 mm (1/2")	[55 N•m (5.6 kgf•m)]
15.88 mm (5/8")	[65 N•m (6.6 kgf•m)]
19.05 mm (3/4")	[100 N•m (10.2 kgf•m)]

12.4.3 Air Tightness Test on the Refrigerating System

Do not purge the air with refrigerants but use a vacuum pump to vacuum the installation.

There is no extra refrigerant in the outdoor unit for air purging.

- Before system is charged with refrigerant and before the refrigerating system is put into operation, below site test procedure and acceptance criteria shall be verified by the certified technicians, and/or the installer.
- Be sure to check whole system for gas leakage.

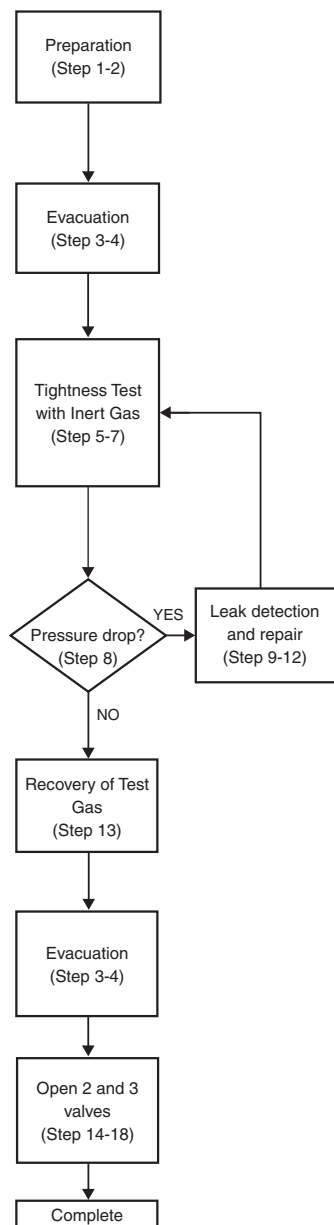

- 1 Connect a charging hose with a push pin to the Low side of a charging set and the service port of the 3-way valve.
- 2 Attach the gauge manifold set correctly and tightly. Make sure that both valves of the manifold gauge (low pressure and high pressure) is in close position.
- 3 Connect the center hose of the manifold gauge to a vacuum pump.
- 4 Turn on the power switch of the vacuum pump, then turn open the low side manifold gauge valve and make sure that the needle in the gauge moves from 0cmHg (0 MPa) to -76 cmHg (-0.1 MPa) or vacuum until 500 microns is achieved. This process continues for approximately ten minutes. Then close the low side manifold gauge valve.
- 5 Remove the vacuum pump from the centre hose and connect the center hose to cylinder of any applicable inert gas as test gas.
- 6 Charge test gas into the system and wait until the pressure within the system to reach min. 1.04MPa (10.4barg).
- 7 Wait and monitor the pressure reading on the gauges. Check if there is any pressure drop.
Waiting time depends on the size of the system.
- 8 If there is any pressure drop, perform step 9-12. If there is no pressure drop, perform step 13.
- 9 Use Gas Leak Detector to check for leaks. Must use the detection equipment with a sensitivity of 5 grams per year of test gas or better.
- 10 Move the probe along the air conditioning system to check for leaks, and mark for repair.
- 11 Any leak detected and marked shall be repaired.
- 12 After repair, repeat evacuation steps 3-4 and tightness test steps 5-7. Check the pressure drop as in step 8.
- 13 If no leak, Recover the test gas. Perform evacuation of steps 3-4. Then proceed to step 14.
- 14 Disconnect the charging hose from the service port of the 3-way valve.

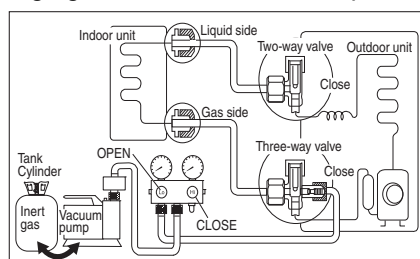

- 15 Tighten the service port caps of the 3-way valve at a torque of 18 N•m with a torque wrench.
- 16 Remove the valve caps of both of the 2-way valve and 3-way valve.
- 17 Open both of the valves, using a hexagonal wrench (4mm).
It is recommended to allow refrigerant slowly flow into the refrigerant system to prevent refrigerant freezing. Slightly open 2-way valve for 5 seconds then close the valve. Repeat this action for 3 cycles then fully open the valve.
- 18 Mount back the valve caps onto the 2-way valve and the 3-way valve to complete this process.

Notes:

Recommended use of any of the following leak detector,

- I) Universal Sniffer leak detector
- II) Electronic halogen leak detector
- III) Ultrasonic Leak Detector

12.4.4 Connect the Cable to the Outdoor Unit

- 1 Remove the control board cover from the unit by loosening the screw.
- 2 **Connection cable** between indoor unit and outdoor unit shall be approved polychloroprene sheathed 4 x 1.5 mm² (3/4 ~ 1.75HP) or 4 x 2.5 mm² (2.0 ~ 2.5HP) flexible cord, type designation 60245 IEC 57 or heavier cord. Do not use joint connection cable. Replace the wire if the existing wire (from concealed wiring, or otherwise) is too short.

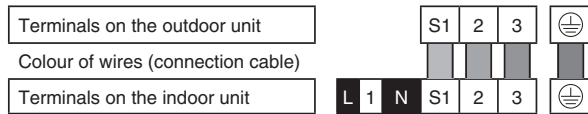

- 3 Secure the cable onto the control board with the holder (clammer).
- 4 Attach the control board cover back to the original position with screw.
- 5 For wire stripping and connection requirement, refer to instruction 12.2.4 of indoor unit.

⚠ WARNING

⊕ This equipment must be properly earthed.

- Earth wire shall be Yellow/Green (Y/G) in colour and longer than other AC wires for safety reason.

12.4.5 Piping Insulation

- 1 Please carry out insulation at pipe connection portion as mentioned in Indoor/Outdoor Unit Installation Diagram. Please wrap the insulated piping end to prevent water from going inside the piping.
- 2 If drain hose or connecting piping is in the room (where dew may form), please increase the insulation by using POLY-E FOAM with thickness 6 mm or above.

12.4.6 Disposal of Outdoor Unit Drain Water

- If a drain elbow is used, the unit should be placed on a stand which is taller than 3 cm.
- If the unit is used in an area where temperature falls below 0°C for 2 or 3 days in succession, it is recommended not to use a drain elbow, for the drain water freezes and the fan will not rotate.

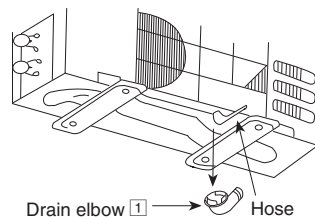

Install the hose at an angle so that the water smoothly flows out.

12.4.7 In Case of Reusing Existing Refrigerant Piping

Observe the followings to decide reusing the existing refrigerant piping.
Poor refrigerant piping could result in product failure.

- In the circumstances listed below, do not reuse any refrigerant piping. Instead, make sure to install a new piping.
 - Heat insulation is not provided for either liquid-side or gas-side piping or both.
 - The existing refrigerant pipe has been left in an open condition.
 - The diameter and thickness of the existing refrigerant piping does not meet the requirement.
 - The piping length and elevation does not meet the requirement.Perform proper pump down before reuse piping.
- In the circumstances listed below, clean it thoroughly before reuse.
 - Pump down operation cannot be performed for the existing air-conditioner.
 - The compressor has a failure history.
 - Oil color is darken. (ASTM 4.0 and above).
 - The existing air-conditioner is gas/oil heat pump type.
- Do not reuse the flare to prevent gas leak. Make sure to install a new flare.
- If there is a welded part on the existing refrigerant piping, conduct a gas leak check on the welded part.
- Replace deteriorated heat insulating material with a new one.
Heat insulating material is required for both liquid-side and gas-side piping.

12.4.8 Proper Pump Down Method

- ① Operate air conditioner at cooling mode for 10 ~ 15 minutes.

Most Important Process
Purpose: To make the oil & refrigerant mix together. They are in separated condition when air conditioner is stopped.

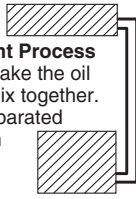

- ② After 10 ~ 15 minutes of pre operation, close 2 way valve. After 3 minutes, close 3 way valve.

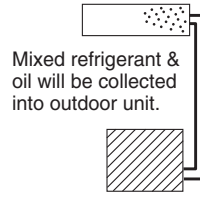
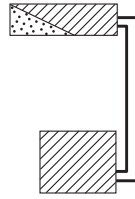

Mixed refrigerant & oil will be collected into outdoor unit.

- ③ Take out air conditioner unit.

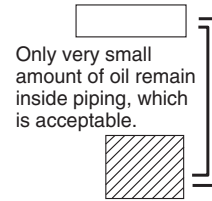

Only very small amount of oil remain inside piping, which is acceptable.

- ④ Install New Refrigerant air conditioner.

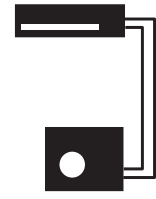

13. Installation and Servicing Air Conditioner using R32

13.1 About R32 Refrigerant

For air conditioning refrigerants such as R410A, the refrigerants were collected back in order to prevent their air dissipation, to curbe the global warming impact, in case they were released into the atmosphere. In the “4th Environmental Basic Plan”, 80% reduction of greenhouse gas emissions by 2050 is required, and due to this requirement, further reduction in the emission of high greenhouse effect gas, such as CFCs, is required. Therefore, the conversion of air conditioning refrigerant into the ones who has smaller greenhouse effect, even if it is dissipated into the atmosphere, became our responsibility.

Nevertheless, in case of air conditioning refrigerant, it would be the best if there is a refrigerant which has smaller impact on global warming, but ensures good energy efficiency and performance, and is safe; however, there is no such refrigerant which satisfies all these conditions. As a result, we have been considering the practical usage, within the safety frame-work, of R32 refrigerant which has short lifetime in the atmosphere, and has smaller effect of global warming, but is slightly flammable.

In 2004, due to the revision of air conditioner safety standards by the International Electro-safety Commission (IEC), the safety standards of air conditioners using slightly flammable refrigerant was issued. In 2010, the regulations of American Society of Heating, Refrigerating and Air-Conditioning Engineers in the United States (ANSI/ASHRAE34) was issued adopting the grades for refrigerants which are difficult to inflame due to their slow burning rates, and as a result have smaller damages in cases of fire. The burning rate of R32 is lower by 10cm / per second, and safety standardization for various usage is now being processed.

13.2 Characteristics of R32 Refrigerant

1. Chemical Characteristics

R32 is one of the refrigerants used in R410A, has almost no toxicity, and chemically stable compound formed by hydrogen, carbon and fluorine.

R32 has short lifetime of 4 to 9 years in case of being released into the atmosphere; therefore, it has smaller greenhouse gas effect but has slight inflammability because of the large proportion of hydrogen.

Chemical Characteristic Table of R32, R410A and R22.

	R32	R410A	R22
Chemical Formula	CH ₂ F ₂	CH ₂ F ₂ / CHF ₂ CF ₃	CH ₂ ClF
Composition (mixture ratio wt.%)	Single Composition	R32 / R125A (50 / 50 wt.%)	Single Composition
Boiling Point (°C)	-51.7	-51.5	-40.8
Pressure (physical) *1	3.14	3.07	1.94
Capacity (physical) *2	160	141	100
COP (physical) *3	95	91	100
Ozone Depletion Potential (ODP)	0	0	0.055
Global Warming Potential (GWP) *4	675	2090	1810
Inflammability *5	Slightly Inflammable (A2L)	Non-inflammable (A1)	Non-inflammable (A1)
Toxicity	None	None	None

*1 : Physical property of temperature condition 50°C

*2 : Relative value of temperature condition 0/50°C, providing R22=100

*3 : Te/Tc/SC/SH=5/50/3/0°C

*4 : GWP=Global Warming Potential, each figure is based on “4th IPCC4 Report”

*5 : Based on ANSI / ASHRAE std. 34-2010

2. Characteristic of Pressure

As shown in Table 2, R32 does not have much difference in vapor pressure at the same refrigerant temperature comparing to R410A, but comparing to R22, it is higher at 1.6 times more. Thus, the same as in case of R410A, it is necessary to do installation and service using high-pressure tools and components.

Table 2. Saturated vapor pressure comparison table

(Unit: MPa)

Temperature	Refrigerant		
	R32	R410A	R22
-20	0.30	0.30	0.14
0	0.71	0.70	0.40
20	1.37	1.35	0.81
40	2.38	2.32	1.43
60	3.84	3.73	2.33
65	4.29	4.17	2.60

Reference : Thermal properties table of Japan Society of Refrigerating and Air Conditioning Engineers (60, 65°C)
NIST REFPROP V8.0 (-20 ~ 40°C)

13.3 Refrigerant piping installation • Tools used in services

13.3.1 Required Tools

R32 refrigerant air conditioners use the common parts as R410A air conditioners for two-way valves and three-way valves (diameters of service ports); thus, they maintain commonality in the maintenance of the compressive strength, the size of pipe flaring, and the size of flare nuts as R410A. Therefore, for refrigerant pipe installation and services, you can use tools for R410A.

However, mixing of refrigerants is not allowed, so that you have to separate the cylinders for the recovery of refrigerants.

Tools used for installation • relocation • replacement of air conditioning units

Works	R32	R410A	R22
Flaring	Flare tools for R410A (clutch type)		Flare tools for R22 (clutch type)
Connection of pipes	Torque wrench (diameter 1/4 3/8)		
	Torque wrench (diameter 1/2 5/8) *1		Toque wrench (diameter 1/2 5/8)
Manifold gauge charging hose	R32 & R410A Common (As at November 2013)		R22 Only
Air purging	Vacuum pump + Reducer / expander		Vacuum pump
Gas leakage test	Detection liquid or soup water, HFC detector		

*1. Nut diameters of 1/2 5/8, the size of torque wrench common with R410A

For other installation, you can use general tools such as screw drivers (+, -), metal saws, electric drills, long-nose pliers, hole core drills ($\varnothing 70$ or $\varnothing 65$), linen tape, levels, temperature gauges, clamp meters, electric knives, nippers, pipe cutters, reamers or scrapers, spring benders, (diameters 1/4 3/8 1/2 5/8), monkey wrenches, fixing wrenches (17 or 12 mm), feeler gauges, hexagon wrenches (4 mm), testers, megohm testers, etc.

Tools used for services

Works	R32	R410A	R22
Insertion of refrigerant	Digital scale for refrigerant charging, refrigerant cylinders, cylinder adopters and packing *a		
Recovery of refrigerant	Refrigerant recovery devices, refrigerant cylinders, manifold gauges, charging hoses *b		

*a. Use cylinder for each refrigerant, cylinder adopter and packing.

*b. Use refrigerant recovery cylinder separately for each refrigerant (**no mixture of refrigerant allowed**). Please be aware that there are some refrigerant collection devices which do not have self-certification.

13.3.2 Tools for R32 (common with R410A)

1. Flare gauges

Use flare gauges when you perform flaring with flare tools (crutch type). Flare gauges are used to set the pipe ends at 0.5 ~ 1.5 mm from clump bars of flare tools.

Flare gauges



2. Flare tools (clutch type)

Flare tools have larger holes of clump bars in order to set the pipe end at 0 ~ 0.5 mm, and have stronger springs inside to ensure solid flaring torques. These flare tools can be used commonly for R22.

Flare tools (clutch type)



3. Torque wrenches (diameters 1/2, 5/8)
 In order to strengthen the compressive strength, the diameters of wrenches change depending on the flare nut sizes.

Torque wrenches

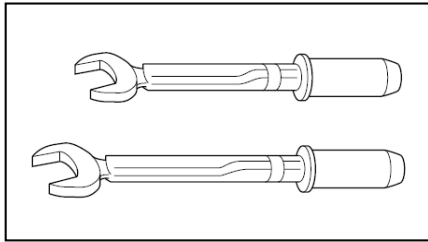

Differences in torque wrenches

	R32 (common R410A)	R22
1/2 (diameter × torque)	26 mm × 55 N•m (550 kgf•cm)	24 mm × 55 N•m (550 kgf•cm)
5/8 (diameter × torque)	29 mm × 65 N•m (650 kgf•cm)	27 mm × 65 N•m (650 kgf•cm)

4. Manifold gauges

R22 gauges cannot be used because of the high pressures.

Each port of manifold has different shapes in order to prevent inserting wrong refrigerant.

*However, the port shape for R410A and R32 is the same; therefore, attention need to be paid not to insert wrong refrigerant.

Differences in high/low pressure gauges

	R32 (common R410A)	R22
High pressure gauges (red)	-0.1 ~ 5.3 MPa -76 cmHg ~ 53 kgf / cm ²	-76 cmHg ~ 35 kgf / cm ²
Low pressure gauges (blue)	-0.1 ~ 3.8 MPa -76 cmHg ~ 38 kgf / cm ²	-76 cmHg ~ 17 kgf / cm ²

Difference in manifold port sizes

	R32 (common R410A)	R22
Port sizes	1/2 UNF20	7/16 UNF20

5. Charging hoses

The pressure resistance of charge hoses is increased. At the same time, the material is changed to HFC resistant, and the size of each manifold adopter is changed, as the port size of manifold gauge itself. Further, some hoses are with anti-gas pressure backflow valves placed near the adopters. (hoses with the valves recommended)

Manifold gauges / Charging hoses

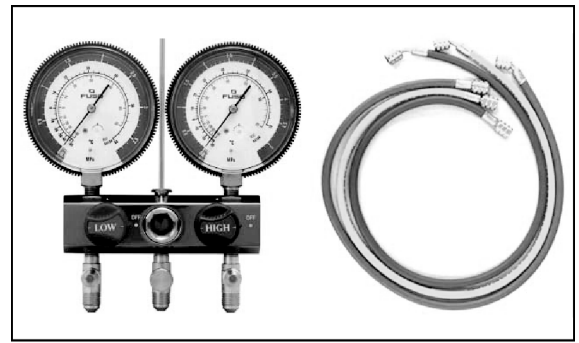

Differences in charging hoses

		R32 (common R410A)	R22
Pressure Resistance	Normal operation pressure	5.1 MPa (52 kgf / cm ²)	3.4 MPa (35 kgf / cm ²)
	Burst pressure	27.4 MPa (280 kgf / cm ²)	17.2 MPa (175 kgf / cm ²)
Material		HNBR rubber Internal nylon coating	NBR rubber

6. Vacuum pump and Vacuum pump adopter

When using a vacuum pump, it is necessary to set a solenoid valve in order to prevent backflow of vacuum pump oil into the charge hoses, and use a vacuum pump with oil backflow prevention function, or use the vacuum pump with vacuum pump adopter.

If vacuum pump oil (mineral oil-based) mixes with R410A (R32), it may cause damage to the machine.

Vacuum pump

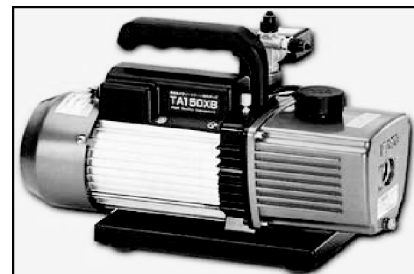

Vacuum pump adopter



7. HFC refrigerant_Electric gas leakage tester
 R32 refrigerant is often used for other mixed refrigerant (R410A, R404A, R407C etc.). Therefore, the usage of existing HFC detectors is possible, but in order to detect more accurately, we recommend to use detectors specially set and adjusted for R32 detection.

HFC refrigerant_Electric gas leakage tester



8. Digital scale for refrigerant charging
 R32 and R410A have high pressure level and their evaporation speed is high. Thus, if you recover the refrigerant by cylinder charging method, the refrigerant evaporates within the weighing scale glass, which makes reading the scale difficult, rather than liquidating the refrigerant into the cylinder. (Charging cylinders for R22 have different pressure resistance, scale, connection port size; therefore, they are not usable) At the same time, the digital scale for refrigerant charging is strengthened by receiving the weight of the refrigerant cylinders with four pillars at the corners. The connection ports of charging hoses have two separate ports for R22 (7/16 UNF20) and R32/R410A (1/2 UNF20) therefore, they can be used for the insertion of the existing refrigerants.

Digital scale for refrigerant charging



9. Refrigerant cylinders
 Refrigerant cylinders for R410A are painted in pink, and the ones for R32 are painted in other colors that might subject to change according to the international standards. R32 is a single refrigerant, so that both liquid and gas insertion are possible. Additional charging is also possible. (R410A is a mixed refrigerant, so only liquid insertion is possible)

Refrigerant cylinders



10. Connection ports of refrigerant cylinders and packing
 Charging ports which fit to the charging hose connection port size (1/2 UNF20) is needed. At the same time, the packing has to be of HFC resistant materials.

Connection ports and packing



11. Tools used for refrigerant piping installations and services

	Tools for R410A	Common with R32	Possibility of usage for R22
1.	Pipe cutters, reamers or scrapers	○	○
2.	Flare tools (clutch type)	○	○
3.	Torque wrench (1/4, 3/8)	○	○
4.	Torque wrench (1/2, 5/8)	○	✕
5.	Manifold gauges · charging hoses	○	✕
6.	Vacuum pumps, vacuum pump adopters	○ Connection 5/16	○ Connection 1/4
7.	Electric gas leakage testers for HFC *1	○	△
8.	Digital scale for refrigerant charging	○	○
9.	HCF recovery devices (connection port 5/16) *2	○ Connection 5/16	○ Connection 1/4
10.	Refrigerant cylinders (pressure resistant: FC3)	Same specs ✕	✕
11.	Refrigerant cylinders (pink)	Other (colors that might subject to change according to the international standards).	✕
12.	Refrigerant cylinder connection ports and packing	○	✕
13.	Allen wrench (4 mm) Electric knives	○	○
*1	Those testers only for HCFC22 (R22), but not for HCF32 (R32) and HCF410A (R410A) cannot be for common use.		
*2	Recovery devices which are self-certified for each HCF type can be used.		
	<p>[Knowledge for the common usage of tools for R410A & R32]</p> <ul style="list-style-type: none"> • R410A and R32 machines use different compressor oils. • If unregulated compressor oil gets mixed into, it may cause damage to the machine function. • Careful pump down will ensure the recovery of compressor oil, and it will minimize the remaining amount of the oil in the manifold gauge and charging hose. • If you only perform the recovery of refrigerant and not be able to perform pump down, <u>you have to dispose the compressor oil in the charging hose.</u> 		
	<p>[Precaution of repairing refrigerant cycle]</p> <ul style="list-style-type: none"> • In the brazing, open 2-way and 3-way valves, and make sure the refrigerant is completely recovered back and not remaining the system. • When repairing outside, make sure no refrigerant is in the air, ensure good air flow, and perform the brazing. 		
	<p>[Inserting wrong refrigerant]</p> <ul style="list-style-type: none"> • It may cause "not cooling" and "not heating" customer claims because each component (expansion valve, compressor, PCB) of the refrigeration cycle is specially adjusted for R32. • At the same time, it is not subject to product warranty, if wrong refrigerant was inserted into the system. 		

13.4 New installation, Relocation, Repairing of Refrigerant Cycle System The Procedures

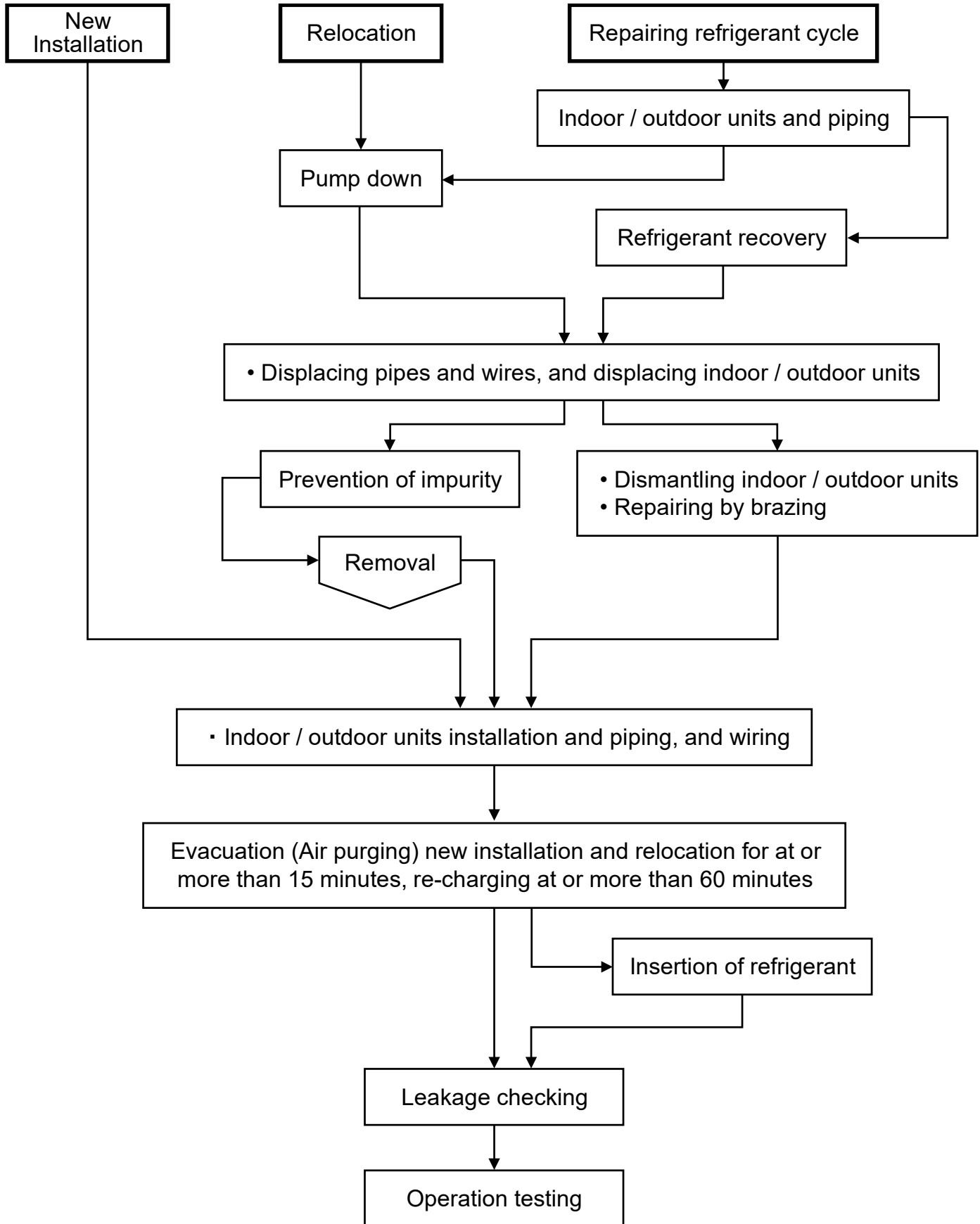

13.5 Piping installation of R32

13.5.1 Pipe materials used and flaring

Copper pipes are used for refrigerant piping. Pipes which comply with JIS Regulations need to be used. Room air conditioners which use R410A and R32 have higher pressure; thus, using pipes which comply with the Regulations is important.

The pipe thickness is regulated by revised JIS B 8607 "Flaring and brazing fittings for refrigerant" and the pipe thickness for R410A, R32 is shown in the table.

Pipe thickness

O and OL materials		Thickness (mm)		
Diameter	Diameter (mm)	R410A	R32	R22
1/4	6.35	0.80		
3/8	9.52	0.80		
1/2	12.70	0.80		
5/8	15.88	1.00		

Caution

- For connection piping, use copper phosphate seamless pipes (1220T) as regulated in "JIS H 3300" and the pipe thickness is 0.8 mm.
- In the market, there are some pipes of 0.7 mm thickness, but do not use these pipes (0.8 mm thickness has to be strictly followed).
- It is recommended to use pipes whose adhesion amount of oil is at or less than 40 mg / 10 m. At the same time, do not use pipes with dent, de-shape, and color change (especially inside).

13.5.2 Processing and connection of pipes

For refrigerant pipe installation, be aware of moisture and dirt do not get into the pipes, and make sure of no refrigerant leakage.

◎ The procedure of flaring and precautions

- Cutting of pipes : use pipe cutter and cut the pipe slowly not to de-shape the pipe.
- Removal of burrs on the edge of pipe (reamer or scraper)
If the condition of pipe edge after the deburring is no good or if burrs attaches on the flaring, it may cause refrigerant leakage. Turn the pipe end down and perform deburring carefully.
- Insert the flare nut (use the nut which is a part of the CZ parts)
- Flaring
Ensure the cleanliness of clump bar and pipe, and perform flaring carefully.
Use the existing flare tools or flare tools for R410A. Be aware that the sizes and dimensions of flaring is different in each flaring tool. If you use the existing flaring tools, use flaring gauge to measure the length of the flaring part.

Piping size (mm)	Dimensions "a" (mm) R22			Dimensions "a" (mm) R410A/R32		
	Flare tools		Flare tools for R410A	Flare tools		Flare tools for R410A
	Clutch type	Wing nut type	Clutch type	Clutch type	Wing nut type	Clutch type
6.35 (1/4")	0.5 ~ 1.0	1.0 ~ 1.5	0 ~ 0.5	1.0 ~ 1.5	1.5 ~ 2.0	0 ~ 0.5
9.52 (3/8")	0.5 ~ 1.0	1.0 ~ 1.5	0 ~ 0.5	1.0 ~ 1.5	1.5 ~ 2.0	0 ~ 0.5
12.70 (1/2")	0.5 ~ 1.0	1.5 ~ 2.0	0 ~ 0.5	1.0 ~ 1.5	2.0 ~ 2.5	0 ~ 0.5
15.88 (5/8")	0.5 ~ 1.0	1.5 ~ 2.0	0 ~ 0.5	1.0 ~ 1.5	2.0 ~ 2.5	0 ~ 0.5

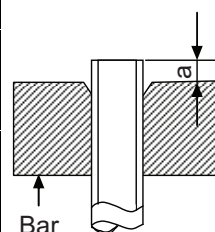

Nut outer diameter (mm)	
R22	R410A
	R32
17	17
22	22
24	26
27	29

13.6 Installation, Relocation, and Service

13.6.1 Air purge and gas leak test for new installation (using new refrigerant pipes) using vacuum pump

(From the point of view of global environment protection, do not release CFCs into the atmosphere during installation work)

1. Connect the charging hose of manifold gauge to the service port of 3-way valve (pushing insect pin).
2. Fully open the handle Lo of manifold gauge and operate vacuum pump.
(If the needle of the low-pressure gauge reaches the vacuum immediately, check 1 procedure again)
3. Perform vacuuming 15 minutes or more, and make sure low pressure gauge reaches to -0.1 MPa (-76 cmHg). When the vacuuming completes, fully open the handle Lo of manifold gauge and stop the operation of vacuum pump, and leave it for 1 ~ 2 minutes. Then, remove the connection side of the charging hose of vacuum pump adopter after checking the needle of manifold gauge does not turn back.
4. Open the stem of 2-way valve to 90° in anti-clock wise, and close the 2-way valve after 10 seconds, and perform gas leakage test.
5. Remove the charge hose from the service port of 3-way valve, and open the stems of 2-way and 3-way valves (open the valves to anti-clock wise carefully, do not use full strength to open)
6. Tighten the service port cap with torque wrench $18 \text{ N}\cdot\text{m}$ ($1.8 \text{ kgf}\cdot\text{m}$)
Tighten the caps of 2-way and 3-way valves with torque wrench $18 \text{ N}\cdot\text{m}$ ($1.8 \text{ kgf}\cdot\text{m}$)
7. After the tightening of each cap, check gas leakage around the cap.

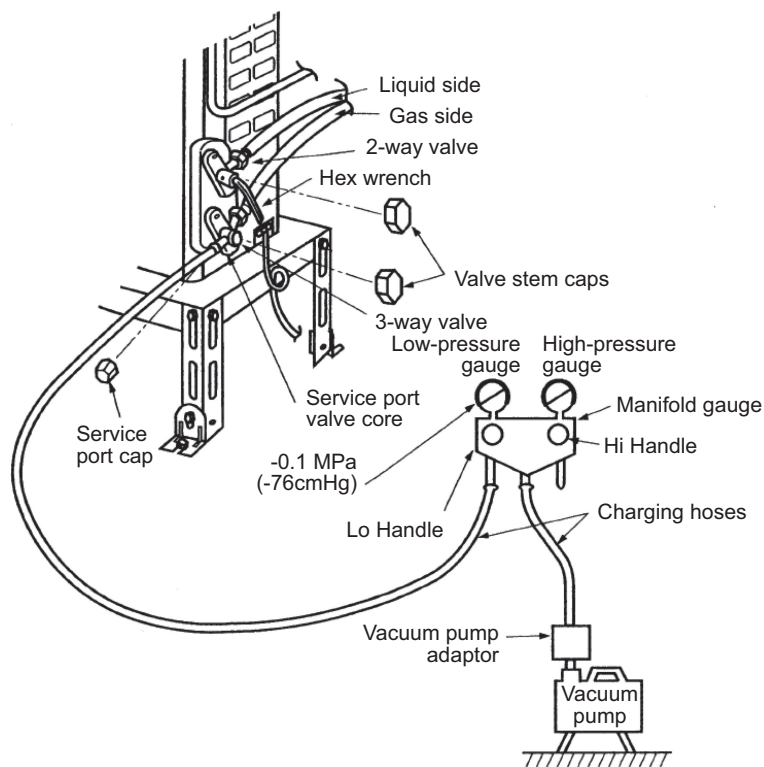

13.6.2 Process of refrigerant recovery

1. Connect the center charging hose of manifold gauge to the in-let side of recovery device.
2. Connect the valves of the discharge side of recovery device and liquid side of refrigerant cylinder with red hose (charging hose).
3. Connect the yellow float switch cable of the recovery device to the refrigerant cylinder.
4. Open the low pressure side valve of manifold gauge.
5. Insert electric plug of recovery device into electrical outlet (the fan operation starts).
6. Turn the valve 1 and 2 of recovery device to pressure equalization point.
7. After a few seconds, turn back the valve 1 and 2 to the original position.
8. Turn the switch of the recovery device to "ON". (the compressor operation starts)
9. When the low pressure of manifold gauge is close to "0", close the low pressure side valve, turn "OFF" the recovery device switch.
10. Remove the center charging hose of manifold gauge from the recovery device.

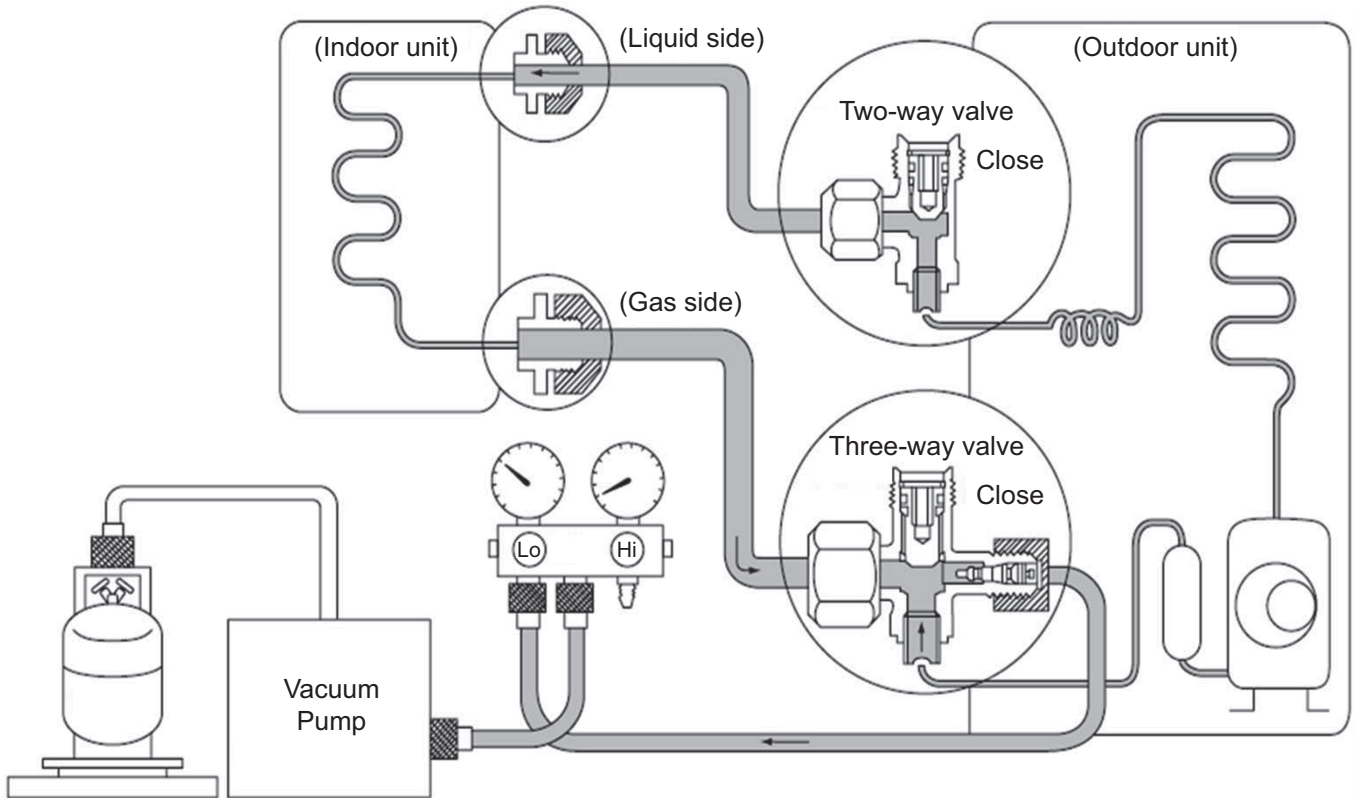

13.6.3 Relocation

1. Removing the air conditioning unit

a) Recovery of outdoor unit refrigerant by pumping down

Press “forced cooling button” (as a general rule, since 1998 the name of cooling testing button is changed, and this name is unified within the air conditioning industry), and then you are able to start cooling operation in which the room temperature is low, and you can recover the refrigerant from the outdoor unit.

1. Check the valve stems of two-way and three-way valves are open by being turned to anti-clockwise (Remove the caps, and confirm the bars are fully open. Use hexagon wrench <4 mm> to open and close the valves).
2. Press the “Emergency Operation” button of the indoor units for five seconds and release [Forced cooling operation] (for old models, press “forced cooling” button). Then, operate the air conditioning unit for about 10 minutes.
3. Turn the stem of the two-way valve to the clock-wise and close the valve.
4. After about 2 ~ 3 minutes, turn the stem of the three-way valve quickly to the clock-wise, and stop the operation.

Caution: In the pump down operation, stop the compressor before removing the refrigerant pipes.

If you do not stop the compressor operation, and if the valve is open and remove the refrigerant pipes, the air may be sucked into the system and causes extreme high temperature in the refrigerant cycle. This may result in rupture or injury, etc.

5. Attach and tighten the caps of two-way and three-way valves with torque wrench.
6. Remove the connecting pipes (liquid side and gas side).

b) Removal of indoor and outdoor units

1. Remove the connecting pipes and wires between the indoor and outdoor units.
2. Attach capping flare nuts on the edges of the pipes, connecting the indoor and outdoor units, in order to prevent dust and moisture get into the pipes.
3. Remove the indoor and outdoor units.

2. Unit installation

Use new refrigerant pipes for the installation, and perform air purging using vacuum pump and gas leakage testing stated in 13.5.1.

13.6.4 Replacement of air conditioning units and evacuation (when re-using the existing pipes)

When replacing the air conditioning units, you might use the existing pipes, but it is recommended to perform flaring again. In case of unit replacement, even if the unit is new refrigerant air conditioner, if the refrigerant oil is different, it may cause problem. Further, when re-using the existing refrigerant pipes, it is recommended to evacuate the pipes as much as possible, due to the reason that much refrigerant oil may be attached on the surface of the pipes. If the pipes are used without evacuation, the remaining refrigerant oil may cause under-performance and abnormal refrigerant cycle caused by non-compatibility of those oils.

13.6.5 Inter-changeability of refrigerant

Do not operate air conditioning units inserting wrong (or mixed) refrigerant (R22, R410A, R32). It may cause malfunction of the units, and at the same time, may cause serious incident such as rupture of the refrigerant cycle.

13.6.6 Re-insertion of refrigerant in service

When re-insertion is needed, follow the procedures to ensure the insertion of new refrigerant at correct amount.

1. Attach charging hose (blue) to the service port of the outdoor unit.
2. Attach charging hose (red) to the vacuum pump. Fully open the 2-way and 3-way valves.
3. Place the refrigerant cylinder on the digital scale for refrigerant charging and connect the charge hose (yellow) to the connection port of the vacuum pump and the digital scale. Leave the cylinder valve fully open.
4. Fully open the handles Lo and Hi of the manifold gauge, and switch on the vacuum pump, and then perform evacuation for at or more than one hour.
5. Confirm the compound gauge of -0.1 MPa (-76cmHg) and fully open the handles of Lo and Hi, and switch off the vacuum pump. Leave it for about 1 ~ 2 minutes and confirm the needle of the compound gauge does not turn back.

Refer to the picture below to follow the procedures below.

6. Remove the charging hose (red) of the manifold gauge from the vacuum pump adaptor.
7. After adjusting the digital scale to zero, open the cylinder valve and the valve Lo of the manifold gauge, and insert the refrigerant.
8. If it is not possible to insert the refrigerant at regulated amount at once, operate the cooling mode and gradually insert the refrigerant (recommended amount approx. 150 g / 1 time)
*Do not insert much refrigerant at once.
9. Close the open/close valve and insert the refrigerant in the charging hose to the outdoor unit.
*Perform this procedure during operating cooling operation. Close the stem of the two-way valve, and when the pressure of the manifold gauge becomes zero (0), quickly remove the charging hose (blue). Immediately open the 2-way valve, and stop the cooling operation.
10. Final checking • • • Confirm the 2-way and 3-way valves are fully open.
Attach the caps of the service port and control valve, and then check the gas leakage around the caps.

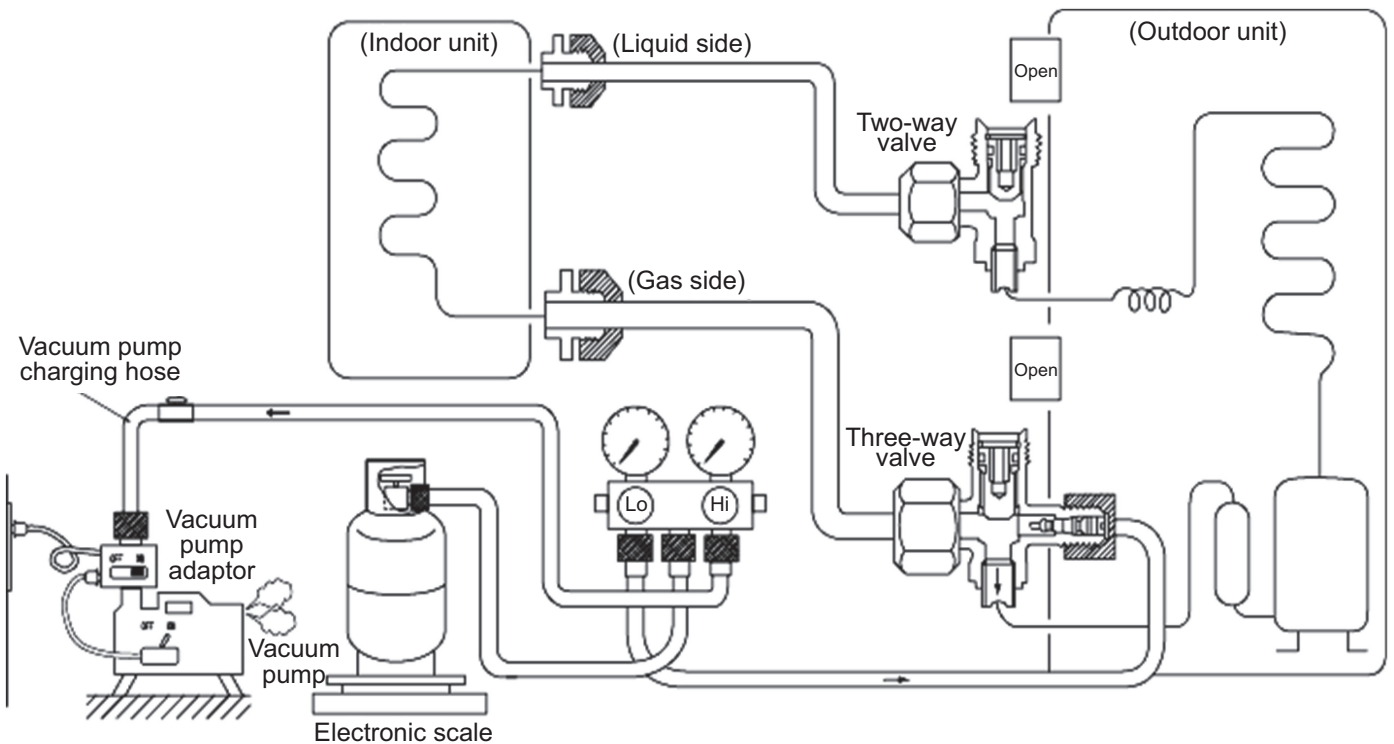

13.7 Repairing of refrigerant cycle / Brazing point

13.7.1 Preparation for repairing of refrigerant cycle / brazing

Brazing which is a technique needed for repairing refrigerant cycle requires advanced technique and experience, and this brazing procedure can only be performed by the workers who completed "Gas Welding Skill Training" regulated by the Occupational Safety and Health Act, and went through the training programs of refrigerant operations. Dismantling and re-connecting (assembling) refrigerant system requires working space, and the space has to ensure good air flow and fire prevention (water bucket and fire extinguisher). Moreover, the worker has to ensure the wearing of goggles, grabs, safety shoes, and long sleeve shirts, and be aware of work safety and attempt to prevent secondary defect (quality assurance of products). For brazing the indoor / outdoor unit structural components (heat exchangers, compressors, expansion valves, four-way valve blocks), after the recovery of all refrigerant, confirm that no refrigerant remains in the system, and fully open the 2-way and 3-way valves. When the brazing is conducted outside, check and make sure no refrigerant is contained in the air (be careful with vaporized refrigerant). Furthermore, protect the compressor terminal with metal plates, and heat but use wet clothes to cool down (releasing the heat) the expansion valves, and four way valves (prevent destruction of parts). In brazing, it is important to pour the brazing material without melting the base metal based on capillary action principle. In case of holes and oxidizing caused by overheating, do not perform re-brazing or alteration but replace the parts.

13.7.2 Adjustment of vacuum pump pressure

1. Cylinder with adjustment handle

1. Check and confirm the adjustment handle of the 1st pressure adjuster is loosen (anticlockwise). If cylinder valve is opened when the 1st gauge pressure adjust handle is closed, the 2nd gauge might get broken.

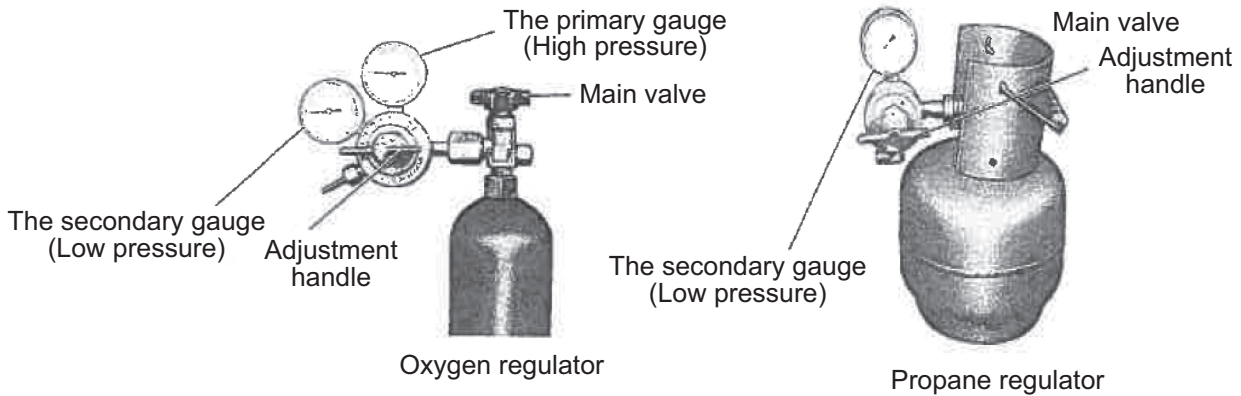

2. Open the cylinder valve, and check the remaining amount with the first side pressure gauge.
3. Check the pressure of 2nd gauge and turn the adjustment handle to clock-wise direction to adjust the pressure.
 - ◎ Oxygen 2nd side gauge pressure 0.5 MPa (5.0 kgf / cm²)
 - ◎ Propane 2nd side gauge pressure 0.05 MPa (0.5 kgf / cm²)

2. Cylinder without adjustment valve
 2nd side gauge pressure is adjusted by the adjuster.
 Check the both side valves of the torch and open the cylinder valve to check the remaining refrigerant in the cylinder.
 Caution: Do not attach oil component on the connection port of the adjuster.
 Especially, use an oxygen cylinder adjuster which is no oil substance type. Do not dismantle or repair the adjuster and pressure gauge.

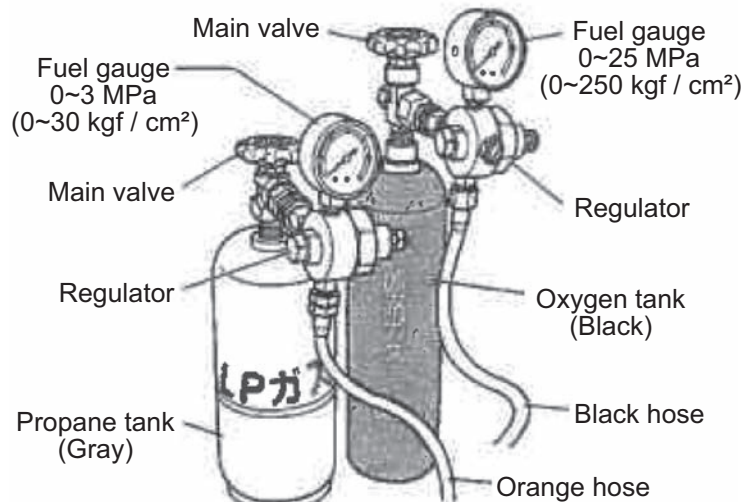

13.7.3 Checking of gas provision

Checking there is no fire around the torch, and then confirm the provision of gas.

1. Slightly open the “propane valve” of the torch, and make sure the gas comes out from the torch crater and then close the “propane valve”.
 2. Slightly open the “oxygen valve” of the torch and make sure the gas comes out from the torch crater and then close the “oxygen valve”.
- Check there is no gas leakage around the hose connection.

13.7.4 Adjustment of flame

1. Slightly open the “propane valve” of the torch and lit with spark lighter.
 This moment, the flame is only by propane and the color is red.
2. Gradually open the “oxygen valve” of the torch to mix oxygen, and adjust the amount of propane and oxygen with the valve to make the flame suitable for brazing work.
 If the white core flame splits into two, the torch crater might be clogged. In this case, remove the crater from the torch and check.

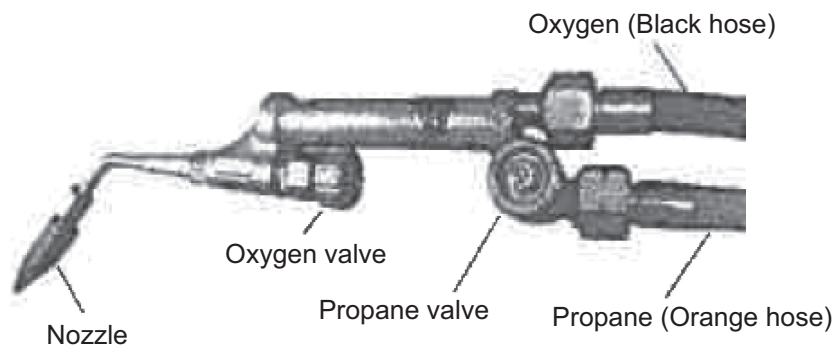

13.7.5 Types of flame

Types of flame change based on the proportion of propane and oxygen.

[Neutral Flame]

Perform brazing with this flame

(This is a flame when oxygen and propane are mixed at proper proportion, and has lesser effect on the brazed metals)

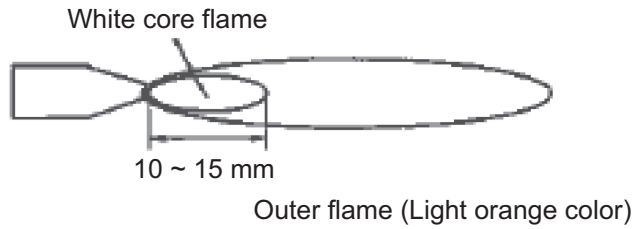

[Carbide Flame]

When propane is excessive, the flame has white color flame in between the white core flame and outer flame. (This is due to the lack of oxygen and the proportion of unburned propane is excessive.)

The black carbon created during the brazing work may contaminate the surface of the brazed metal).

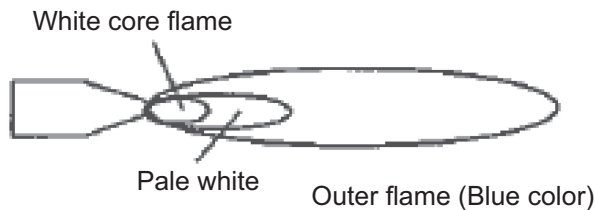

[Oxidizing Flame]

Oxygen is more compared to the neutral flame. Although the flame size is small, this has the highest flame heat. However, due to the excessive oxygen contained in the flame, the brazing point gets oxidized. (This flame may cause holes, due to the high heat. The pipe may get melt)

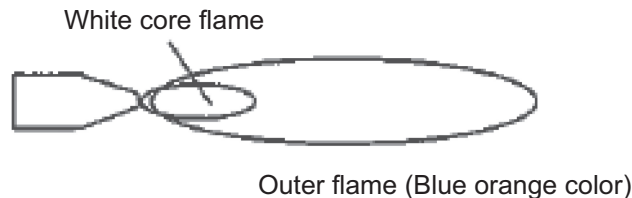

13.7.6 Closing the flame

[In case of short break]

1. Close the "propane valve" of the torch.
2. Close the "oxygen valve" of the torch.

[In case of finishing work]

1. As above, close the flame following the procedure of "In case of short break".
 2. Completely close the valves of oxygen and propane cylinders.
 3. Release the remaining gas inside the hose by opening the "oxygen valve" and "propane valve" of the torch.
- Confirm the 1st and 2nd side gauge pressures of "oxygen" and "propane" cylinder pressure adopter are "zero".

13.7.7 Selection of brazing material

Use BAg brazing material (silver solder) to increase the welding performance.

Category	JIS Standard Number	Composition of ingredients (%)						Temperature (°C)			Tensile strength (Reference)		Characteristics and applications
		Ag	Cu	Zu	Cd	Ni	P	Solidus	Liquidus	Brazing temp	Kgf•cm ²	Base material	
BAg	BAg • 1A	49.0 ~ 51.0	14.5 ~ 16.5	14.5 ~ 18.5	17.0 ~ 19.0	—	—	approx. 625	approx. 635	635 ~ 760	45.5	S20C	Liquidity is good at low temperature, it is preferable to a small junction of the gap in the universal form.
	BAg • 1	44.0 ~ 56.0	14.0 ~ 16.0	14.0 ~ 18.0	23.0 ~ 25.0	—	—	approx. 605	approx. 620	620 ~ 760	45.5	S20C	It has similar performance to the BAg • 1A, and suitable for every base material except the light weight metal.
	BAg • 2	34.0 ~ 36.0	25.0 ~ 27.0	19.0 ~ 23.0	17.0 ~ 19.0	—	—	approx. 605	approx. 700	700 ~ 845	45.5	S20C	It is a brazing filler metal in universal form, suitable for a slightly larger gap junction.
	BAg • 3	48.0 ~ 51.0	14.5 ~ 16.5	13.5 ~ 17.5	15.0 ~ 17.0	2.5 ~ 3.5	—	approx. 630	approx. 690	690 ~ 815	35 ~ 70	SS ~ SUS	It has good corrosion resistance in stainless steel-based brazing, suitable for brazing tungsten carbide, aluminum bronze and copper.
BCuP	BCuP-2	—	remain	—	—	—	6.8 ~ 7.5	approx. 710	approx. 785	690 ~ 815	21 ~ 24.5	Cu	Good liquidity, suitable for brazing copper tube.
	BCuP-3	4.8 ~ 5.2	remain	—	—	—	5.8 ~ 6.7	approx. 645	approx. 815	720 ~ 815	21 ~ 24.5	Cu	Suitable for brazing when the joint spacing is not constant
	BCuP-5	14.5 ~ 15.5	remain	—	—	—	4.8 ~ 5.3	approx. 645	approx. 800	705 ~ 815	21 ~ 24.5	Cu	When brazing of copper and copper, it is used without a flux, but not possible for brazing basic materials

Caution

BCuP (phosphorus copper wax) is easy to react with sulfur, and makes a brittle compound water soluble, and causes gas leakage. In hot spring areas, use other brazing materials or paint the surface for protection.

13.7.8 Need of flux

Use flux to protect the base materials.

1. Remove impurity and oxide film on the metal base, and improve the flow of the brazing material.
2. Prevent oxidation of the metal surface in brazing.
3. Reduce the surface tension of the brazing material.

13.7.9 Need of nitrogen gas

In order to prevent oxidation in the pipe, perform the brazing operation in nitrogen gas flow. Flow rate 0.05 m³ / h, or pressure reducing valve at 0.02 MPa (0.2kgf / cm²) below.

13.7.10 Checking of brazing (insert) points

1. No impurity on the brazing point
If dirt or oil is attached on the brazing point, the brazing filler metal does not reach to junction, and it may cause poor welding.
2. Adequate gap space in the brazing point
The advantage of capillary current situation is used in brazing. If the gap space is too large, this phenomenon may not occur and it may cause poor welding because brazing filler metal does not flow to join the front part.
3. Appropriate size for insertion
The guideline for pipe insertion dimensions is to three times the diameter of the base material, but you need to decide the insertion size in consideration of the clogging of the brazing material. Generally, for thin pipes, you need to increase the insert size, and for thick pipe vice versa.
4. Brazing material to flow from top to bottom
Brazing filler metal will easily flow to the connecting portion by capillary action. Further, by bending the brazing portion of [dryer side] of the capillary tube at 120°, you can prevent the damage of dryer inside and the clogging of brazing material caused by the excessive insertion of capillary tube.

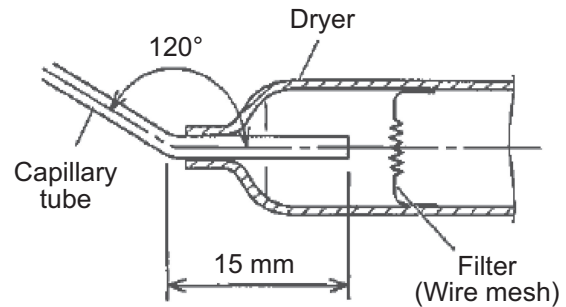
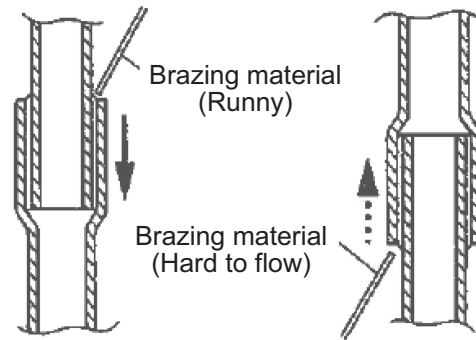
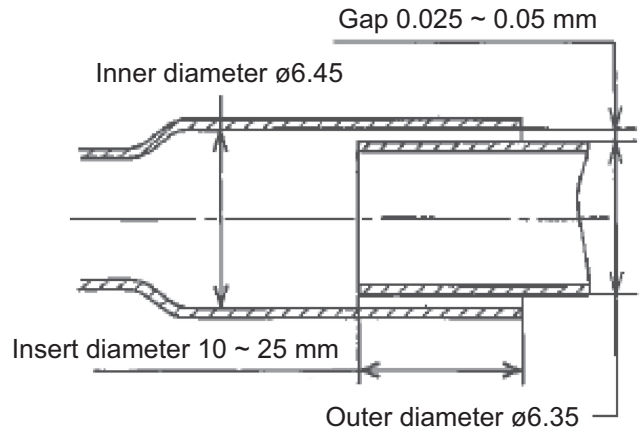

13.7.11 Brazing and heating

1. Place the flame to a pipe which has more heat capacity in order to let the brazing material melt by the pipe heat. Heat the pipe up to the melting temperature of the brazing material, but when it is overheating, assess the temperature by pipe color in order not to melt the pipe.

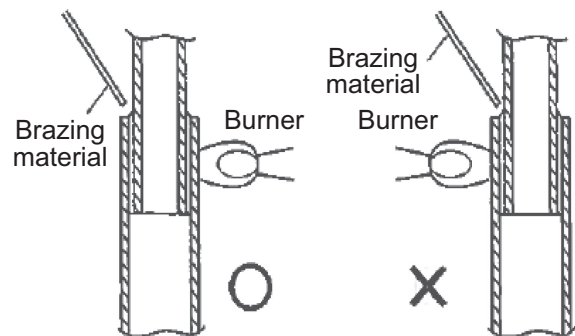

The pre-heating is to heat the base material until the melting temperature, and requires certain training to distinguish the color of the heated base material in order not to melt the material.

- The color and temperature of copper tube
- Becoming red color •••••••• 480°C
 - Dull red •••••••• 650°C
 - Cherish red •••••••• 760°C
 - Brightening cherish red •••••••• 870°C

(Reference)

Melting temperature of copper ••••••• Approx. 1083°C

Maximum temperature obtained in propane and oxygen ••••••• Approx. 1083°C

The important point is to heat the bonding part uniformly within a short period of time until reaching to the brazing temperature in the following manner.

2. Apply the flame on to the side with better heat transmission. If the pipe thickness is consistent, by heating like 30% iron and 70% copper, the copper pipe inside reaches to brazing temperature. Iron pipes have low heat transmission and only the part the flame is applied get high temperature, and this causes oxidization of the pipe. The flow of the brazing filler is affected negatively.
3. Apply the flame on to the side of larger heat capacity.
When brazing a thin tubes such as capillary tube and dryer, etc., caution has to be taken to apply the flame to the dryer side (thick pipe side), in order to prevent burn out by the heat.
4. When brazing the compressor connection pipes (suction and discharge), remove the sound insulation plate and the fan, and place the compressor stand vertically (to prevent the leakage of compressor refrigerating machine oil), and apply the flame from the compressor body side.

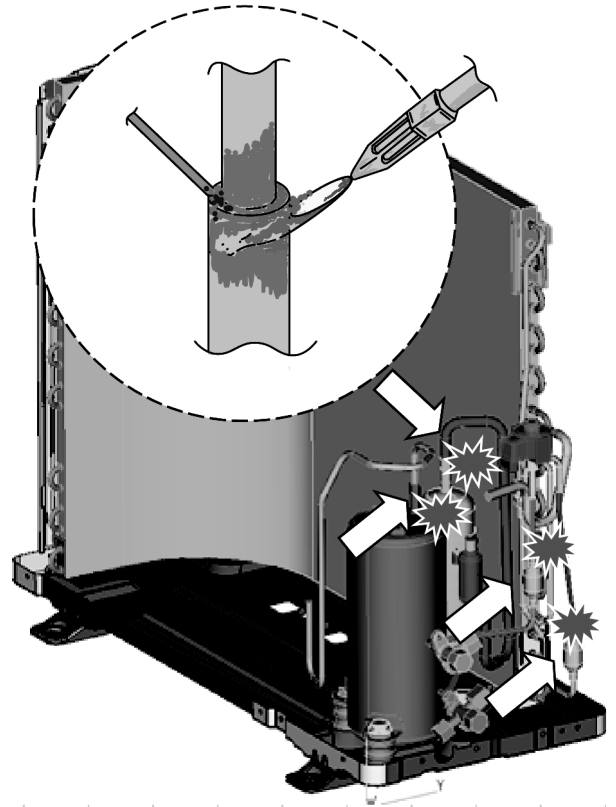

13.7.12 Terminologies of brazing

Pin holes → Small holes are generated on the surface of the brazing metal.

Wet temperature → Liquidus temperature at which the brazing material starts flowing out by heating, generally it is the liquidus-line temperature.

Blow holes → Hollows made by gas in the brazing material of brazing portion (gas reservoirs).

Pits → As a result of blow holes, small dents generated on the outside surface of welding.

Voids → The brazing material does not reach completely to the brazing part. It cannot be identified from outside.

13.8 <Reference> Analysis method for no error code, no cooling / no warming

13.8.1 Preparation for appropriate diagnosis

In order to obtain appropriate operation characteristics, minimum 15 minutes or more operation time [testing operation (rated operation)] is required.

1. Method of rated operation (rated operation)

For the models which have two buttons of “emergency operation and forced cooling operation”, press forced cooling button once. For the models which have only emergency operation button, press the button once for 5 seconds and when hear “beep” sound, release the button. Then, cooling operation starts.

2. Checking the mal-functions of indoor / outdoor units

- 1) Any obstacles against heat release and air suction? (short circuit)
(Forget to remove the outdoor unit cover or fallen leaves blocking the outdoor unit)
- 2) Are the indoor unit air filters clean? (obstructing heat suction)
- 3) Is the setting temperature on the remote controller correct? (is the setting temperature set at lower/higher than the room temperature?)

13.8.2 Understanding and verification of refrigerant cycle

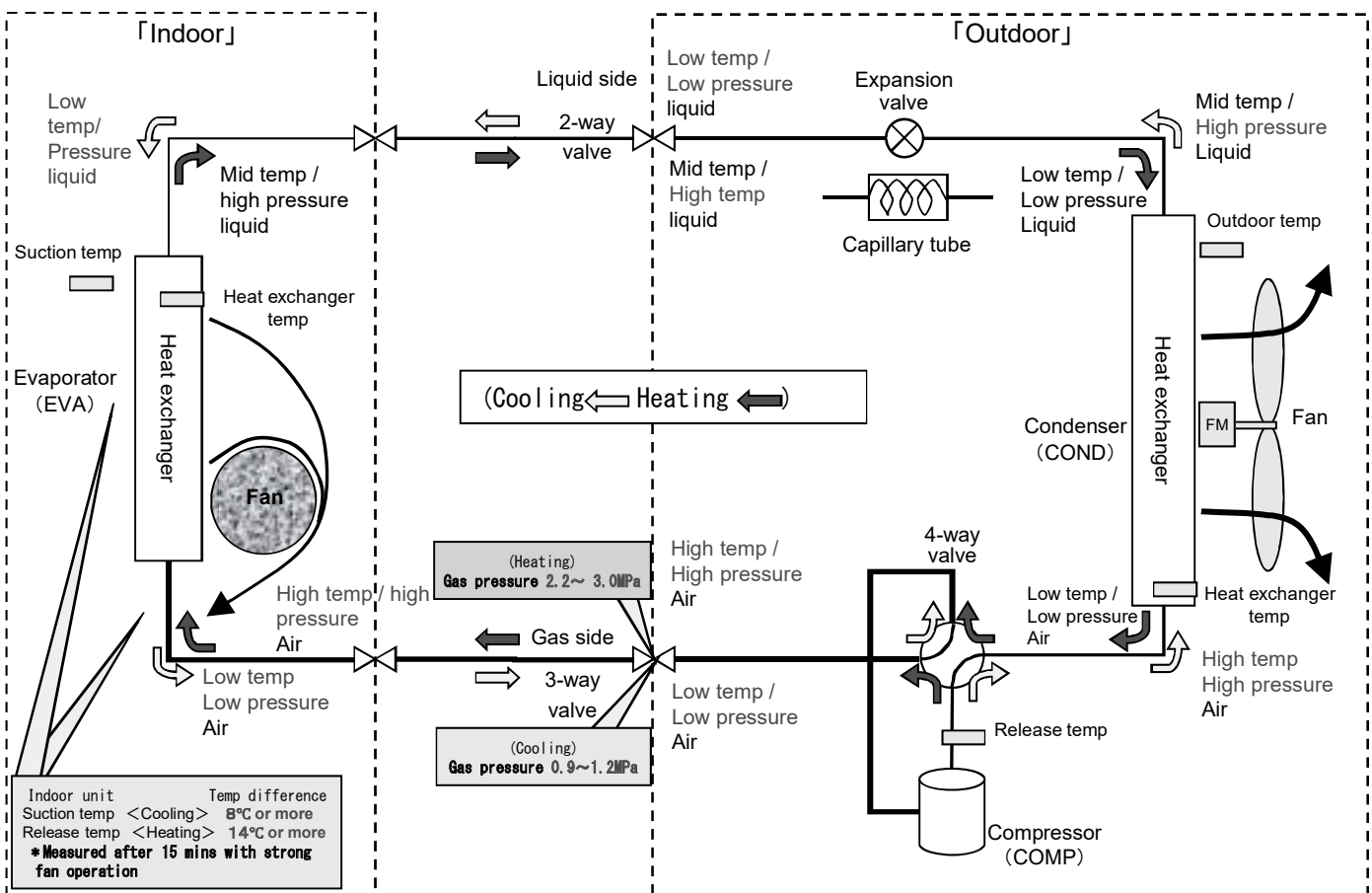

1. Measuring temperature
 - 1) Indoor unit suction temperature, release temperature, temperature difference, → Measure by thermometer
 - 2) 2-way valve pipe temperature in cooling mode is low temperature (benchmark : 5 ~ 10°C), in heating mode is medium temperature (benchmark : 25 ~ 35°C).
 - 3) 3-way valve pipe temperature in cooling mode is low temperature (benchmark : 7 ~ 15°C) in heating mode is high temperature (benchmark : 38 ~ 50°C).
2. Measuring electric current
 - Measuring electric current in operation → check by clamp meter (refer to table of technical characteristic guideline)
3. Measuring pressure
 - Measuring gas pressure → check the pressure by manifold gauge (refer to table of technical characteristic guideline)
4. Any sound from the expansion valve?
(when starting the operation and the outdoor unit is turned on, the expansion valve is re-set, check if there is any edged sound or clack sound)

13.8.3 Guidance for diagnosis of refrigerant cycle

Comparison with normal operation	Cooling mode	
	High	Low
Refrigerant pressure	Excess insertion of refrigerant	Clogged capillary, expansion valve malfunction
	Heat releasing obstruction	Clog by moisture
	Dirty condenser, attachment of impurity	Lack of refrigerant gas
	Compressor malfunction	
Operation electric current	Excess insertion of refrigerant	Lack of refrigerant gas
	Heat releasing obstruction	Compressor malfunction
	Dirty condenser, impurity	Mixture of air
		(Insufficient evacuation)
2-way valve temperature	Excess insertion of refrigerant	Clogged capillary, expansion valve malfunction
	Compressor malfunction	Lack of refrigerant gas
3-way valve temperature	Lack of refrigerant gas • Compressor malfunction	Excess insertion of refrigerant
	Clogged capillary, expansion valve malfunction	

Suction temperature & Release air temperature	Temperature difference at or less than 8°C in cooling operation • • • Causes		
	• Heat releasing obstruction	• Dirty condenser	• Attachment of impurity
	• Lack of refrigerant gas	• Excess insertion of refrigerant	
	• Mixture of air	• Mixture of moisture	
	• Clogged capillary	• Expansion valve malfunction	• Compressor malfunction

◎ Above all are based on the condition that the installation work is properly performed (no issues in indoor / outdoor pipe connections, etc.)

14. Operation Control

14.1 Basic Function

Inverter control, which equipped with a microcomputer in determining the most suitable operating mode as time passes, automatically adjusts output power for maximum comfort always. In order to achieve the suitable operating mode, the microcomputer maintains the set temperature by measuring the temperature of the environment and performing temperature shifting. The compressor at outdoor unit is operating following the frequency instructed by the microcomputer at indoor unit that judging the condition according to internal setting temperature and intake air temperature.

14.1.1 Internal Setting Temperature

Once the operation starts, remote control setting temperature will be taken as base value for temperature shifting processes. These shifting processes are depending on the air conditioner settings and the operation environment. The final shifted value will be used as internal setting temperature and it is updated continuously whenever the electrical power is supplied to the unit.

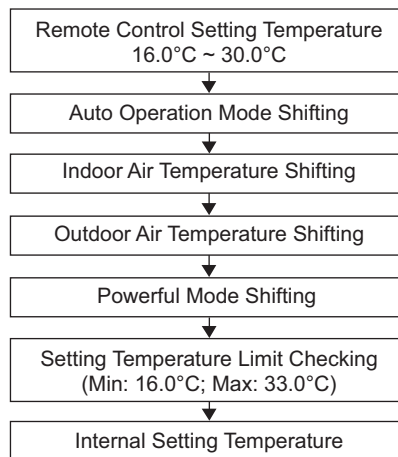

14.1.2 Cooling Operation

14.1.2.1 Thermostat control

- Compressor is OFF when Intake Air Temperature - Internal Setting Temperature < -1.5°C continue for 3 minutes.
- When compressor is OFF (Thermostat OFF) and AUTO FAN is set, the fan will stop periodically.
- Compressor is ON after waiting for 3 minutes, if the Intake Air Temperature - Internal Setting Temperature > Compressor OFF point.

14.1.3 Soft Dry Operation

14.1.3.1 Thermostat control

- Compressor is OFF when Intake Air Temperature - Internal Setting Temperature < -2.0°C continue for 3 minutes.
- When compressor is OFF (Thermostat OFF) and AUTO FAN is set, the fan will stop periodically.
- Compressor is ON after waiting for 3 minutes, if the Intake Air Temperature - Internal Setting Temperature > Compressor OFF point.

14.1.4 Heating Operation

14.1.4.1 Thermostat control

- Compressor is OFF when Intake Air Temperature - Internal Setting Temperature > +1.5°C (Z20~42XK), *2.0°C (Z50/71XK) continue for 3 minutes.
- Compressor is ON after waiting for 3 minutes, if the Intake Air Temperature - Internal Setting Temperature < Compressor OFF point.

14.1.5 Automatic Operation

- This mode can be set using remote control and the operation is decided by remote control setting temperature, remote control operation mode and indoor intake air temperature.
- During operation mode judgment, indoor fan motor (with speed of Lo-) is running for 30 seconds to detect the indoor intake air temperature.
- Every 10 minutes, the indoor temperature is judged.
- For the 1st judgment
 - If indoor intake temperature - remote control setting temperature $\geq 2.0^{\circ}\text{C}$, COOL mode is decided.
 - If $-2.0^{\circ}\text{C} \leq$ indoor intake temperature - remote control setting temperature $< 2.0^{\circ}\text{C}$, DRY mode is decided.
 - If indoor intake temperature - remote control setting temperature $< -2.0^{\circ}\text{C}$, HEAT mode is decided.

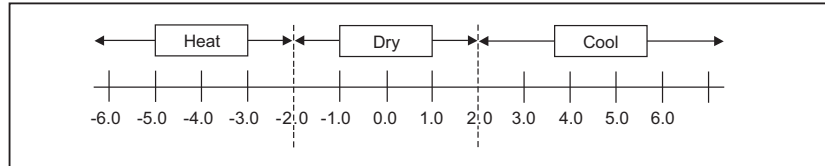

- For the 2nd judgment onwards
 - If indoor intake temperature - remote control setting temperature $\geq 3.0^{\circ}\text{C}$, if previous operate in DRY mode, then continue in DRY mode, otherwise COOL mode is decided.
 - If $-2.0^{\circ}\text{C} \leq$ indoor intake temperature - remote control setting temperature $< 3.0^{\circ}\text{C}$, maintain with previous mode.
 - If indoor intake temperature - remote control setting temperature $< -2.0^{\circ}\text{C}$, HEAT mode is decided.

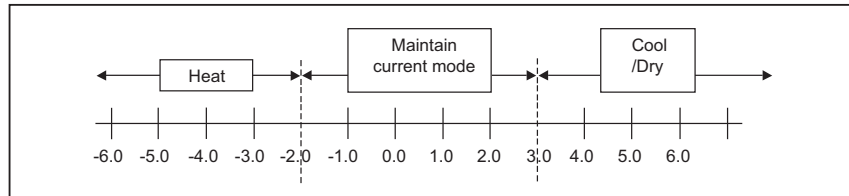

14.2 Indoor Fan Motor Operation

14.2.1 Basic Rotation Speed (rpm)

A. Basic Rotation Speed (rpm)

i. Manual Fan Speed

[Cooling, Dry]

- Fan motor's number of rotation is determined according to remote control setting.

Remote control	○	○	○	○	○
Tab	Hi	Me+	Me	Me-	Lo

- When thermostat off, the fan speed will be limited to max Me fan.
- In COOL mode, when the room temperature reaches near the set temperature, the compressor stops, then the indoor unit fan speed reduced.
- To prevent the room humidity rising, the indoor fan will resume running according to the set fan speed when room temperature increase.

[Heating]

- Fan motor's number of rotation is determined according to remote control setting.

Remote control	○	○	○	○	○
Tab	SHi	Me+	Me	Me-	Lo

ii Auto Fan Speed

[Cooling, Dry]

- According to room temperature and setting temperature, indoor fan speed is determined automatically.
- When set temperature is not achieved, the indoor fan will operate according to pattern below.

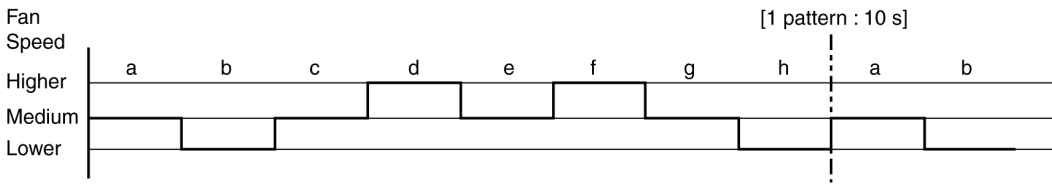

- When set temperature achieved, the indoor fan speed will be fixed. When thermostat off, the fan stop periodically.
- [Heating]

- According to indoor pipe temperature, automatic heating fan speed is determined as follows.

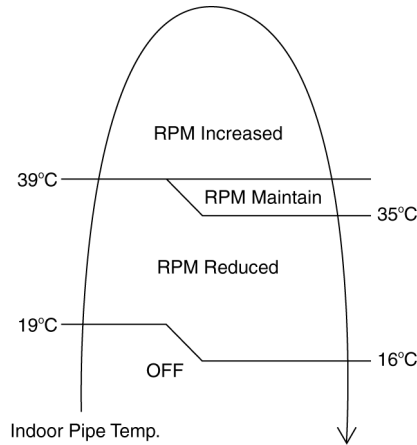

B. Feedback control

- Immediately after the fan motor started, feedback control is performed once every second.
- During fan motor on, if fan motor feedback ≥ 2550 rpm or < 50 rpm continue for 10 seconds, then fan motor error counter increase, fan motor is then stop and restart. If the fan motor counter becomes 7 times, then H19 - fan motor error is detected. Operation stops and cannot on back.

14.3 Outdoor Fan Motor Operation

- It starts when compressor starts operation and it stops 30 seconds after compressor stops operation.

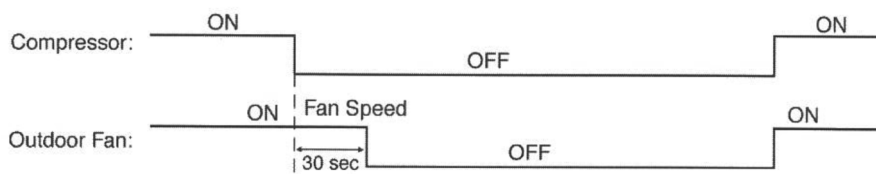

- During cooling operation, and outdoor ambient temperature is below 8°C, outdoor fan speed will be controlled according to outdoor piping temperature as following:

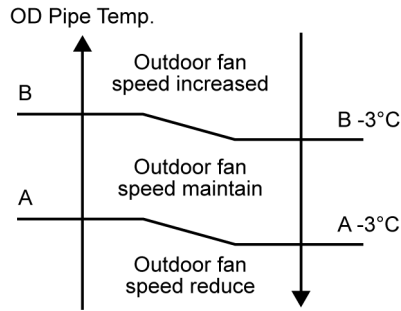

	OD Pipe Temperature
A	26°C
B	33°C

- During above condition, when indoor heat exchanger temperature is below 5°C, the outdoor fan will stop according to outdoor piping temperature as following:

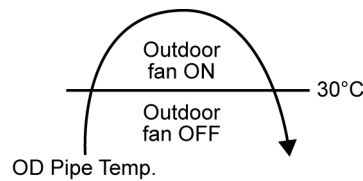

14.4 Airflow Direction

- There are two types of airflow, vertical airflow (directed by horizontal vane) and horizontal airflow (directed by vertical vanes).
- Control of airflow direction can be automatic (angles of direction is determined by operation mode, heat exchanger temperature and intake air temperature) and manual (angles of direction can be adjusted using remote control).

14.4.1 Vertical Airflow

Z20/25/35/42XKEW & XZ20/25/35XKEW

Operation Mode	Airflow Direction		Inner Vane Angle (°)					Outer Vane Angle (°)				
			1	2	3	4	5	1	2	3	4	5
Cooling/Dry	Auto	Not yet achieve set temperature	7 ~ 40					4 ~ 45				
		Achieve set temperature	7					4				
	Auto Swing		7 ~ 40					4 ~ 45				
	Manual		7	15	20	30	40	4	14	25	34	45
Heating	Manual		15	20	35	50	56	19	25	34	43	49
	Auto	A	15					19				
		B	54					43				
		C	20					25				
	Auto Swing		20 ~ 56					25 ~ 49				

Z50/71XKEW & XZ50XKEW

Operation Mode	Airflow Direction		Inner Vane Angle (°)					Outer Vane Angle (°)				
			1	2	3	4	5	1	2	3	4	5
Cooling/Dry	Auto	Not yet achieve set temperature	13 ~ 52					6 ~ 34				
		Achieve set temperature	13					6				
	Auto Swing		13 ~ 52					6 ~ 34				
	Manual		13	20	31	42	52	6	17	23	28	34
Heating	Manual		20	27	35	53	65	17	25	34	39	49
	Auto	A	20					17				
		B	35					34				
		C	20					17				
	Auto Swing		35 ~ 65					34 ~ 49				

- Automatic vertical airflow direction can be set using remote control; the vane swings up and down within the angles as stated above. For heating mode operation, the angle of the vane depends on the indoor heat exchanger temperature as Figure 1 below. It does not swing during fan motor stop. When the air conditioner is stopped using remote control, the vane will shift to close position.
- Manual vertical airflow direction can be set using remote control; the angles of the vane are as stated above and the positions of the vane are as Figure 2 below. When the air conditioner is stopped using remote control, the vane will shift to close position.
- If automatic control (AUTO) or automatic swing (AUTO SWING) vane is selected, the inputs of the control are: mode of operation, inlet temperature, and heat exchanger temperature.
- If manual vane is selected, the inputs are: Up-and-down vane actual signal.

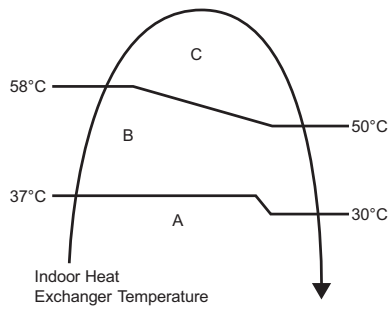
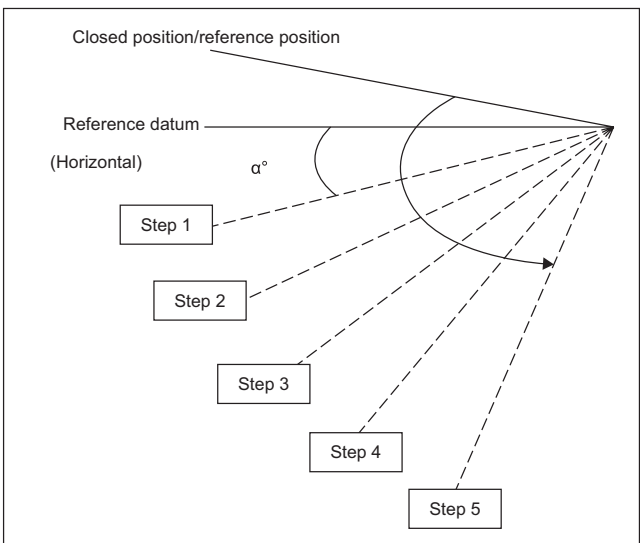
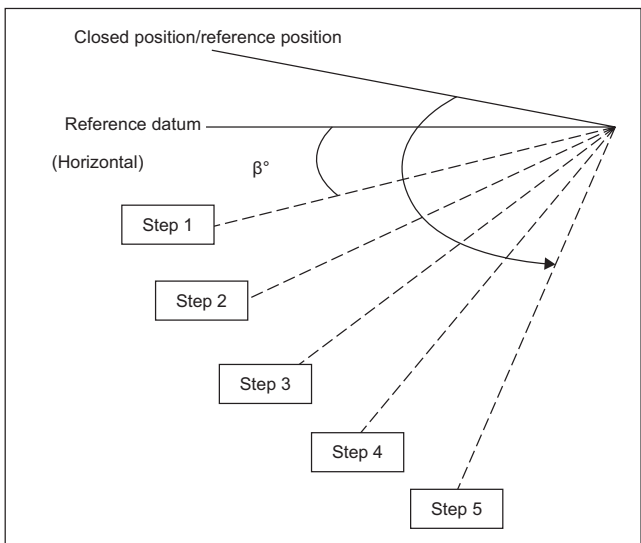
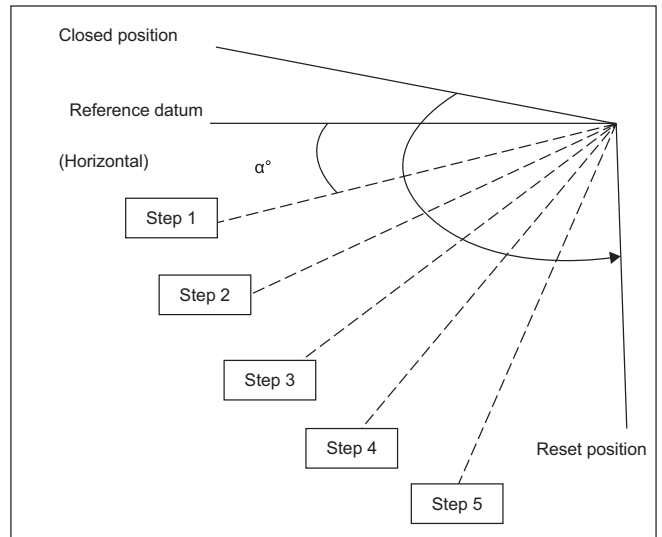
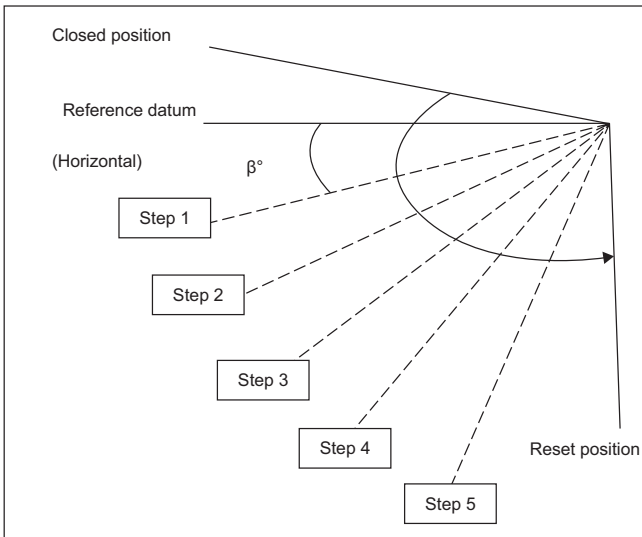

Figure 1

For Z20/25/35/42XKEW





* The horizontal vane angle tolerance is within +/- 5 degree.

14.4.2 Horizontal Airflow

- Automatic horizontal airflow direction can be set using remote control; the vane swings left and right within the angles as stated below. For heating mode operation, the angle of the vane depends on the indoor heat exchanger temperature as Figure 1 below. It does not swing during fan motor stop.

Operation Mode		Vane Angle (°)
Heating, with heat exchanger temperature	A	60 ~120
	B	90
Cooling and soft dry		60 ~120

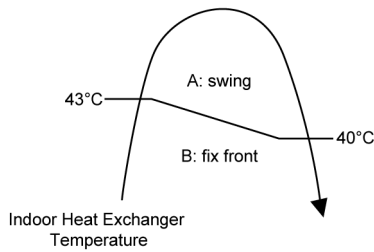

Figure 1

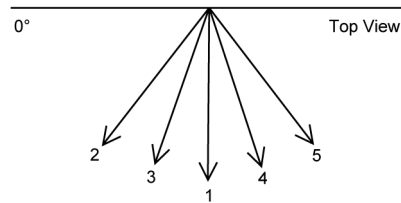

Figure 2

- Manual horizontal airflow direction can be set using remote control; the angles of the vane are as stated below and the positions of the vane are as Figure 2 above.

Pattern	1	2	3	4	5
Airflow Direction Patterns at Remote Control					
Vane Angle (°)	90	60	75	105	120

* The vertical vane angle tolerance is within +/- 5 degree.

14.5 Quiet Operation (Cooling Mode/Cooling Area of Dry Mode)

- Purpose
 - To provide quiet cooling operation compare to normal operation.
- Control condition
 - Quiet operation start condition
 - When “FAN SPEED/QUIET” button at remote control is pressed continuously until QUIET will be shown on remote control display.
 - Quiet operation stop condition
 - When one of the following conditions is satisfied, quiet operation stops:
 - POWERFUL button is pressed.
 - Stop by OFF/ON switch.
 - Timer “off” activates.
 - When FAN SPEED/QUIET button is pressed again and fan speed is change to Low.
 - Sleep mode timer delay OFF.
 - When quiet operation is stopped, operation is shifted to normal operation with previous setting.
 - When operation mode is changed, quiet operation is shifted to quiet operation of the new mode.
 - During quiet operation, if timer “on” activates, quiet operation maintains.
 - After off, when on back, quiet operation is not memorized.
- Control contents
 - Fan speed is changed to QLo.

14.6 Quiet Operation (Heating)

- Purpose
 - To provide quiet heating operation compare to normal operation.
- Control condition
 - Quiet operation start condition
 - When “FAN SPEED/QUIET” button at remote control is pressed continuously until QUIET will be shown on remote control display.
 - Quiet operation stop condition
 - When one of the following conditions is satisfied, quiet operation stops:
 - POWERFUL button is pressed.
 - Stop by OFF/ON switch.
 - Timer “off” activates.
 - When FAN SPEED/QUIET button is pressed again and fan speed is change to Low.
 - Sleep mode timer delay OFF.
 - When quiet operation is stopped, operation is shifted to normal operation with previous setting.
 - When operation mode is changed, quiet operation is shifted to quiet operation of the new mode.
 - During quiet operation, if timer “on” activates, quiet operation maintains.
 - After off, when on back, quiet operation is not memorized.
- Control contents
 - Fan speed is changed to QLo.

14.7 Powerful Mode Operation

- When the powerful mode is selected, the internal setting temperature will shift lower up to 2.0°C (for Cooling/Soft Dry) or higher up to 3.5°C (for Heating) than remote control setting temperature for 20 minutes to achieve the setting temperature quickly.

14.8 Timer Control

- There are 2 sets of ON and OFF timer available to turn the unit ON or OFF at different preset time.
- If more than one timer had been set, the upcoming timer will be displayed and will activate in sequence.

14.8.1 ON Timer Control

- ON timer 1 and ON timer 2 can be set using remote control, the unit with timer set will start operate earlier than the setting time.
This is to provide a comfortable environment when reaching the set ON time.
- 60 minutes before the set time, indoor (at fan speed of Lo-) and outdoor fan motor start operate for 30 seconds to determine the indoor intake air temperature and outdoor air temperature in order to judge the operation starting time.
- From the above judgment, the decided operation will start operate earlier than the set time as shown below.

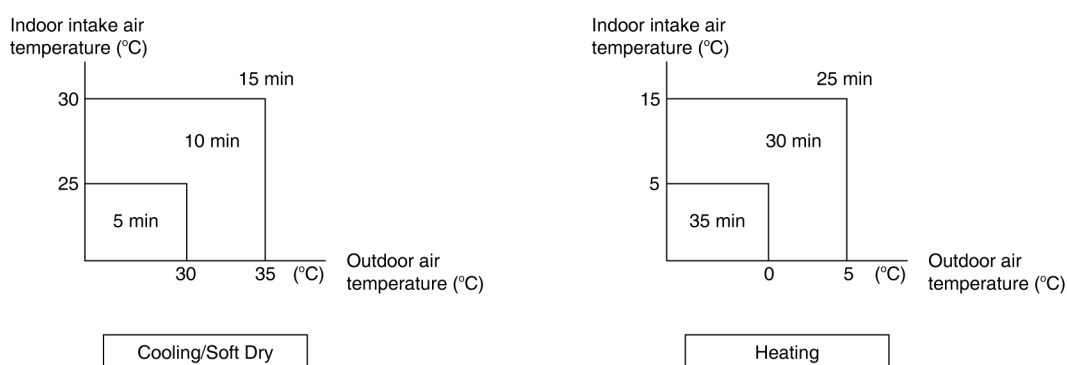

14.8.2 OFF Timer Control

OFF timer 1 and OFF timer 2 can be set using remote control, the unit with timer set will stop operate at set time.

14.9 Sleep Mode Operation

This operation provide comfortable environment while sleeping. It will automatically adjust the sleep pattern temperature during the activation period.

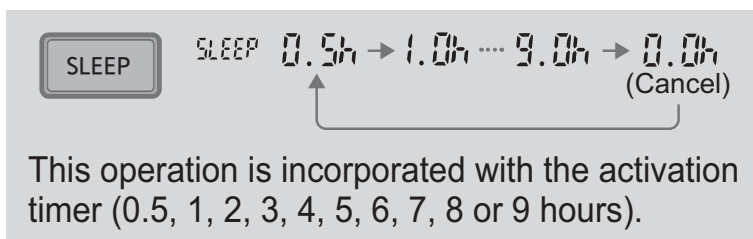

Start Condition:

- Sleep button on remote controller is pressed.
- Select OFF timer: 0.5, 1, 2, 3, 4, 5, 6, 7, 8, 9 hours.

Control content:

- Sleep function maximum running hour is 9 hours.
- When Sleep off timer running out, unit will automatically OFF.
- When unit resume from power failure, Sleep function will not resume.
- Sleep operation can be set together with Timer operation. Sleep operation has priority over OFF Timer.
- Indicator shall be dimmed when this operation is activated.

Control pattern:

- Cooling mode

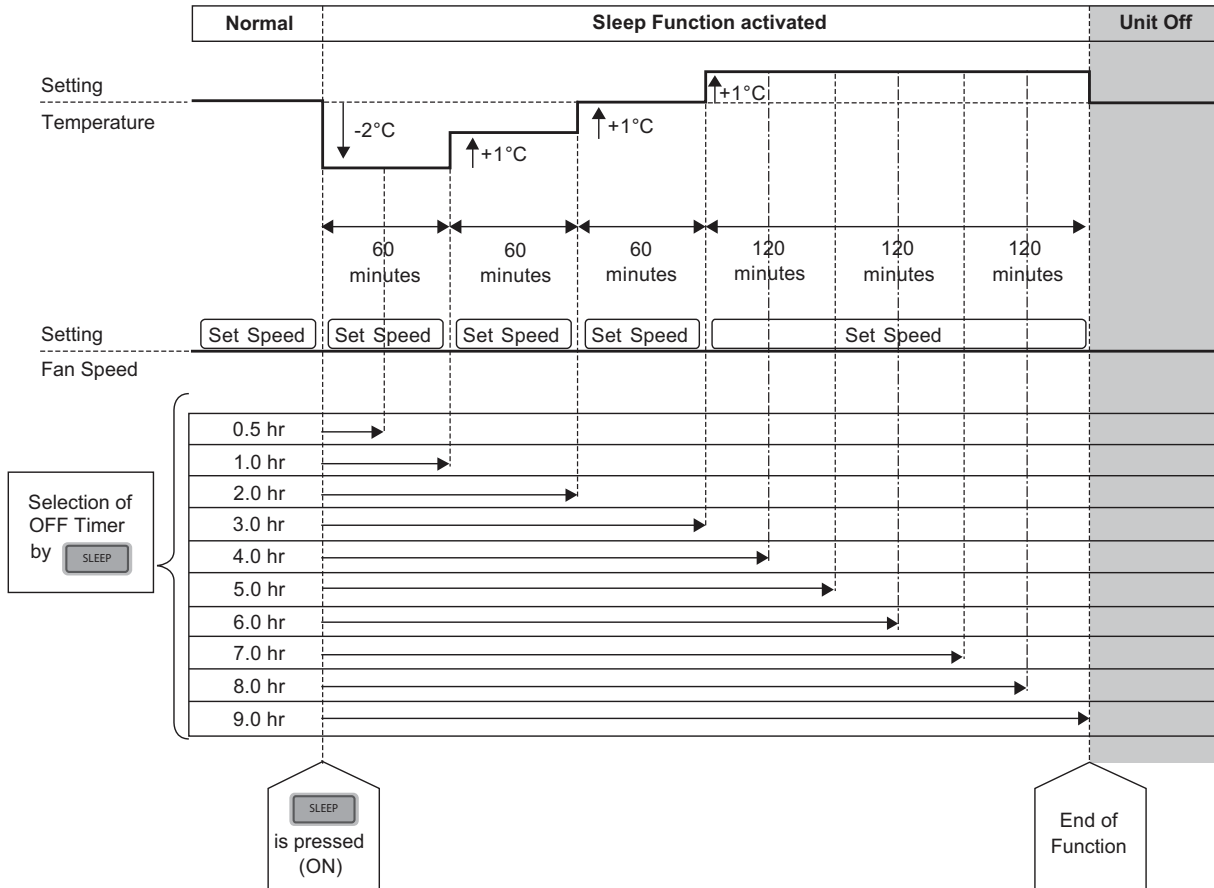

- Heating mode

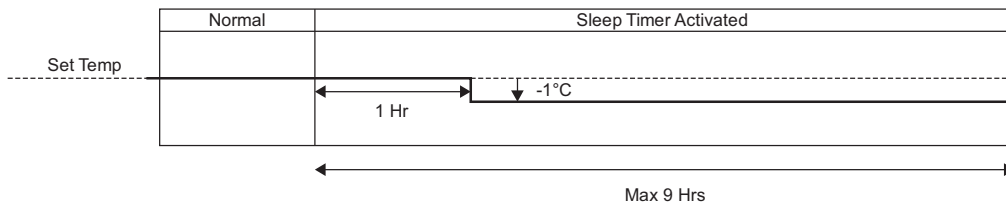

- Sleep operation will not undergo temperature shift when it collaborate with below operation. However, it will execute the delay timer.
 - Powerful mode operation
 - Quiet mode operation
 - Mild dry operation

Stop Condition:

- When sleep operation is cancel by pressing respective button until sleep timer reaches 0.0h.
- ON/OFF button is pressed.
- When sleep operation ends.

14.10 Auto Restart Control

- When the power supply is cut off during the operation of air conditioner, the compressor will re-operate within three to four minutes (there are 10 patterns between 2 minutes 58 seconds and 3 minutes 52 seconds to be selected randomly) after power supply resumes.
- This type of control is not applicable during ON/OFF Timer setting.
- This control can be omitted by open the circuit of JP1 at indoor unit printed circuit board.

14.11 Indication Panel

LED	POWER	TIMER	nanoe X	📶
Color	White	White	White	White
Light ON	Operation ON	Timer Setting ON	nanoe ON	Wireless LAN Mode ON
Light OFF	Operation OFF	Timer Setting OFF	nanoe OFF	Wireless LAN Mode OFF

Note:

- If POWER LED is blinking, the possible operation of the unit are Hot Start, during Deice operation, operation mode judgment, or ON timer sampling.
- If Timer LED is blinking, there is an abnormality operation occurs.

14.12 nanoe™ X Operation

- Generate nanoe™ X (water wrapped ion particle) to moisturize skin, provide deodorization & sterilization effect.
- nanoe™ X operation start condition
 - During unit running at any operation mode, if nanoe™ X operation is activated, combination operation (operation mode + nanoe™ X operation) starts.
 - During unit is OFF, if nanoe™ X operation is activated, nanoe™ X individual operation starts.
- nanoe™ X operation stop condition
 - When OFF/ON button is pressed to stop the operation.
 - When nanoe™ X button is pressed.
 - When OFF Timer activates.
- nanoe™ X operation pause condition
 - When indoor fan stop (during deice, odor cut control, thermostat off, etc.). nanoe™ X operation resume after indoor fan restarts.
 - When indoor intake temperature $\geq 35^{\circ}\text{C}$ and $\leq 5^{\circ}\text{C}$. nanoe™ X operation resume after indoor intake temperature $< 35^{\circ}\text{C}$ or $\geq 5^{\circ}\text{C}$ continuously for 6 minutes.
- Indoor fan control
 - During any operation mode combines with nanoe™ X operation, fan speed follows respective operation mode. However, nanoe™ X system enabled when fan speed ≥ 360 rpm to ensure proper negative ion distribution, nanoe™ X system disabled when fan speed < 360 rpm.
 - During nanoe™ X individual operation, fan speed follow remote control setting. Auto Fan Speed for nanoe™ X individual operation is cooling medium fan. Powerful & Quiet is disabled during nanoe™ X.
- Airflow direction control
 - During any operation mode combines with nanoe™ X operation, airflow direction follows respective operation mode.
 - During nanoe™ X individual operation, Air Swing follow remote control setting.
- Timer control
 - When ON Timer activates when unit stops, previous operation resumes and restored last saved nanoe™ X operation status.
 - When ON Timer activates during any operation, no change on current operation.
 - When OFF Timer activates during any operation, all operation stops and the latest nanoe™ X operation status is saved.
- Indicator
 - When nanoe™ X starts, nanoe™ X indicator ON.
- Remote control receiving sound
 - Normal Operation → nanoe™ X Operation : Beep
 - nanoe™ X Operation → Normal Operation : Beep
 - Stop → nanoe™ X individual Operation : Beep
 - nanoe™ X individual Operation → Stop : Long Beep

- Power failure
 - During nanoe™ X individual operation, if power failure occurs, after power resumes, nanoe™ X individual operation resumes immediately.
 - During combination operation, if power failure occurs, after power resumes, combination operation resume immediately.
- nanoe™ X check mode
 - To enable nanoe™ X check mode, during nanoe™ X operation ON:

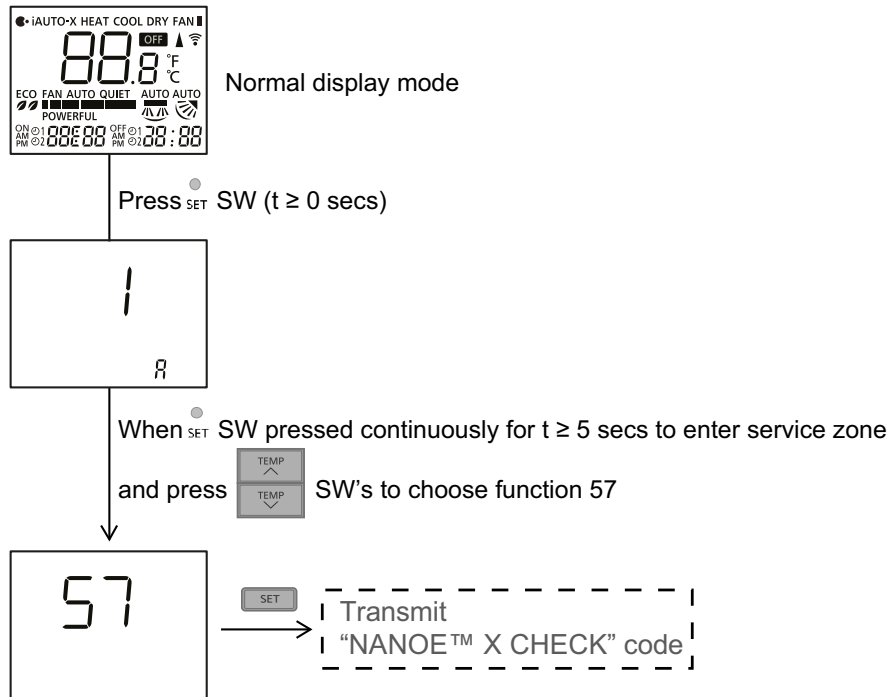

- During nanoe™ X check mode, H67 is judged when disconnection detected. Timer LED blinks.
- nanoe™ X Abnormal Detection
 - Disconnection Abnormality
 - Abnormal detection condition
 - Start from 1 sec after nanoe™ X power ON, 6 secs has passed and in this 6 secs period, abnormal signal is detected continuously for 5.9 secs.
 - Action after abnormal detection condition fulfilled
 - Disconnection counters +1, nanoe™ X power OFF for 5 minutes and then restart. However, according to action mode and disconnection counter, below will be implemented:
 - During nanoe™ X Check Mode: Disconnection abnormality will judged when disconnection counter ≥ 1 . Abnormal code: H67 will memorized in EEPROM, Timer LED blinking and nanoe™ X LED Off.
 - Other Than Above: Disconnection abnormality will judged when disconnection counter ≥ 3 . Abnormal code: H67 will memorized in EEPROM and nanoe™ X LED OFF, Timer LED not blinking.
 - Disconnection counters clear condition >
 - Disconnection counter will be cleared when operation stop. (Not nanoe™ X Check Mode)
 - nanoe™ X Discharge Abnormality
 - Abnormal detection condition
 - After 30 minutes nanoe™ X power ON, abnormal signal is being detected continuously for 5s.
 - Action after abnormal detection condition fulfilled
 - Abnormal discharge counter +1, nanoe™ X power OFF for 30 minutes and then restart. When abnormal discharge counter ≥ 12 , abnormal code: H67 in analyze area (Area where abnormal code not displayed) will be memorized.
 - Abnormal discharge counters clear condition
 - Discharge counter will be cleared when operation become normal for 50 mins above or when operations stop.

14.13 Mild Dry Cooling Operation

- This operation helps to prevent decreases in room humidity while maintaining the setting temperature.
- During unit running at Cooling operation mode, if “Mild Dry Cooling” button is pressed, Mild Dry Cooling operation starts and Mild Dry Cooling indicators turns ON at remote control display.
- Mild dry cooling operation is unavailable when the unit is operating Auto mode and Soft Dry model operation.
- Mild dry cooling operation is cancelled when the unit turned OFF, Mild Dry Cooling button is pressed again or when the operation mode changed from Cooling to other mode.
- Powerful, Quiet and Mild Dry Cooling mode cannot function at the same time, the unit will follows the operation according to the last signal received.
- During this operation, the compressor frequency changes according to operating condition to prevent room humidity decreases and when AUTO AIR SWING is set, the vertical airflow direction fixed at lower limit position.

14.14 Wireless LAN Control

14.14.1 System Overview.

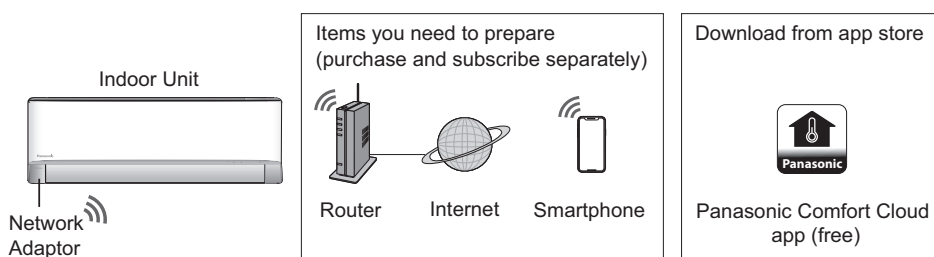

- Requires the APP to work with a smartphone with Android 5.0 and above, or iOS 9 and above. However, there is no guarantee that the APP will work well with all Android OS version.
- The Network Adaptor is designed specifically as a terminal for Panasonic Comfort Cloud app.
- The Wireless LAN network coverage must reach the air conditioner installation location.

Specification

Network Adaptor	Wireless LAN Module (built-in)
Model	DNSK-P11
Input Voltage	DC 5V (From Air Conditioner Indoor Unit)
Current Consumption	Tx/Rx max. 290/100 mA
Wireless LAN standard	IEEE 802.11 b/g/n
Frequency range	2.4 GHz band
Encryption	WPA2-PSK (TKIP/AES)

Precaution

- Do NOT disassemble or alter this Network Adaptor in any way.
- Do NOT remove this Network Adaptor from the appliance product's during operations.
- Data transmitted and received over radio waves may be intercepted and monitored.

Maximum radio-frequency power transmitted in the frequency bands

Type of wireless	Frequency band	Max. EIRP (dBm)
WLAN	2412 - 2472 MHz	20 dBm



14.14.2 Connecting Network

- Press to communicate with the home wireless LAN access point.
- Wireless LAN LED blinks to indicate the connection status to home access point.

Fast blink	The unit is establishing the connection.
Slow blink	The unit is not securing the connection.
No blink (stays on)	The unit is has established the connection.

- It can establish the connection to the unit even If the unit turned OFF.

14.14.3 Application Installation

<p>For Android user (Android 5.0 and above)</p> <ul style="list-style-type: none"> • Open  . • Search for Panasonic Comfort Cloud app. • Download and install. 	<p>For iOS user (iOS 9 and above)</p> <ul style="list-style-type: none"> • Open  . • Search for Panasonic Comfort Cloud app. • Download and install.
--	--

- Note
- The app user interface image may change for version upgrade without notification.
 - There is no charge for using this application. However, other charges may be incurred for connection and operation.

14.14.4 To Disconnect Wireless LAN (Off Wireless LAN LED)

- Press and release one time at the Remote Control Wireless LAN button and the LED will turn off. (LED ON -> LED OFF).

14.14.5 To Delete Wireless LAN Information

- If Wireless LAN is off (LED is Off), turn on Wireless LAN first by press and release one time the Wireless LAN button. (LED OFF -> LED ON).
- Push Wireless LAN button for 5 seconds.
- In the Remote Control Operation select “5” and push for 3 seconds.
- Initialization is finish and Wireless LAN LED will off automatically.

14.14.6 To Check Wireless LAN Signal Strength

- Confirm the air conditioner operation is stopped and press the Wireless LAN button for 5 seconds.
- Select “4” in the remocon then press set button and operation stops.
- After 5 seconds, the signal strength is shown on the indoor unit Wireless LAN LED.
 Strong Signal: Blink 3 times with an interval.
 Moderate Signal: Blink 2 times with an interval.
 Weak Signal: Blink once with an interval.
 No Signal: OFF.
- It will stop automatically after 10 minutes. To stop immediately, press Wireless LAN button.

14.14.7 Wireless LAN Failure Diagnosis

14.14.7.1 Between ID Micon and Wireless LAN Module Failure Detect Condition

- When module and ID micon (CN-LAN) communication is following below condition.
 - No response against sending data.
 - Reply error against sending data.
 - Regularly sending from AC unit (Every 1 minutes).
- Either one from above condition occur, detection will start.
- If for certain time there is no communication and retry is implemented 3 times continuously confirm the error by following below table.
- When failure diagnosis H85 occur.

	Wireless LAN LED	Timer LED
When error condition check	Light up	No light
When retry	Light up	No light
After confirm failure	No light	Blinking

- Cancel Condition: From the module the reply data or the regularly sending data (normal data) is recognized by ID micon.

	Wireless LAN LED	Timer LED
When failure canceled	Light up	No light

- Failure communication parameter setting.

H85 communication error: time/retry counter	10 min/3 count
Wireless LAN disconnection judgment time	300 sec

14.14.8 Between ID AC and Broadband Router Failure Detect Condition

- Detect condition: Communication with router is interrupted.
- Confirm condition: The interrupted condition continue more than 5 minutes and retry is implemented.
- After confirm the failure operation: Not H85 error display and Wireless LAN LED is blinking.
- Cancel condition: Communication is return between Wireless LAN router.
- After cancel, return to normal operation and Wireless LAN LED is light up.

15. Operation Control (For Multi Split Connection)

During multi split connection, indoor unit's operation controls are same with single split connection unless specified in this chapter.

15.1 Cooling operation

15.1.1 Thermostat control

- Capability supply to indoor unit is OFF (Expansion valve closed) when Intake Air Temperature — Internal setting temperature < -2.0°C.
- Capability resume supply to indoor unit after waiting for 3 minutes, if the Intake Air temperature — Internal setting temperature > Capability supply OFF point.

15.2 Soft Dry Operation

15.2.1 Thermostat control

- Capability supply to indoor unit is OFF (Expansion valve closed) when Intake Air Temperature — Internal setting temperature < -3.0°C.
- Capability resume to indoor unit after waiting for 3 minutes, if the Intake Air temperature — Internal setting temperature > Capability supply OFF point.

15.3 Heating Operation

15.3.1 Thermostat control

- Capability supply to indoor unit is OFF (Expansion valve closed) when Intake Air Temperature — Internal setting temperature > +1.0°C.
- During this condition, the indoor fan is stopped if compressor is ON.
- Capability resume supply to indoor unit after waiting for 3 minutes, if the Intake Air Temperature — Internal setting temperature < Capability supply OFF point.

15.3.2 Temperature Sampling Control

- Temperature sampling is controlled by outdoor unit where room temperature for all power supply ON indoor unit could be obtained.
- When capability supply to the indoor unit is OFF and the compressor is ON, the indoor fan motor is stopped. During this condition, 15 seconds after sampling signal from outdoor unit is received, the indoor fan start operation at low fan speed.
- However, within first 4 minutes of capability stopped supply to the indoor unit, even sampling signal is received, the sampling control is cancelled.

15.4 Automatic Operation

- This mode can be set using remote control and the operation is decided by remote control setting temperature, remote control operation mode, indoor intake and outdoor air temperature.
- During operation mode judgment, indoor fan motor (with speed of -Lo) and outdoor fan motor are running for 30 seconds to detect the indoor intake and outdoor air temperature. The operation mode is decided based on below chart.

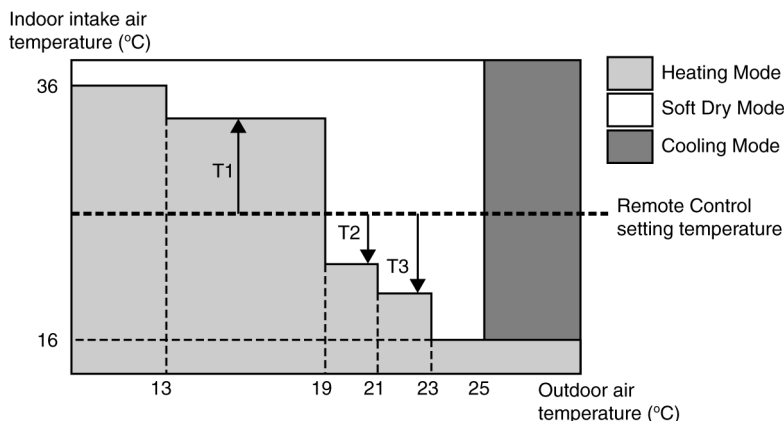

- Every 180 minutes, the indoor and outdoor temperature is judge. Based on remote control setting temperature, the value of T1 will increase up to 10°C, T2 will decrease by 3°C and T3 will decrease up to 8°C.

15.5 Indoor Fan Motor Operation

15.5.1 Residual Heat Removal Control

- To prevent high pressure at indoor unit, when heating mode thermostat-off condition or power supply OFF, indoor fan continue to operate at controlled fan speed for maximum 30 seconds then stop.

15.6 Powerful Mode Operation

- When the power mode is selected, the internal setting temperature will shift lower up to 4.0°C for Cooling/Soft Dry or higher up to 6.0°C for heating than remote control setting temperature, the powerful operation continue until user cancel the Powerful operation by pressing powerful button again.

15.7 Auto Restart Control

- When the power supply is cut off during the operation of air conditioner, the compressor will re-operate between three to four minutes (10 patterns to be selected randomly) after power resume.
- During multi split connection, Indoor unit will resume previous mode, include unit standby mode.

15.8 Indication Panel

LED	POWER	TIMER	nanoe X	Wi-Fi
Color	White	White	White	White
Light ON	Operation ON	Timer Setting ON	nanoe ON	Wireless LAN Mode ON
Light OFF	Operation OFF	Timer Setting OFF	nanoe OFF	Wireless LAN Mode OFF

Note:

- If POWER LED is blinking (0.5 seconds ON, 0.5 second OFF), the possible operation of the unit are during Indoor Residual Heat Removal, Hot Start, during Deice operation, operation mode judgment, or ON timer sampling.
- If POWER LED is blinking (2.5 seconds ON, 0.5 second OFF), the unit is in standby mode.
- If TIMER LED is blinking, there is an abnormality operation occurs.

15.9 Mild Dry Cooling Operation

- During multi split connection, Mild Dry Cooling Operation is disabled.

16. Protection Control

16.1 Protection Control for All Operations

16.1.1 Restart Control (Time Delay Safety Control)

- The Compressor will not turn on within 3 minutes from the moment operation stops, although the unit is turned on again by pressing OFF/ON button at remote control within this period.
- This control is not applicable if the power supply is cut off and on again.
- This phenomenon is to balance the pressure inside the refrigerant cycle.

16.1.2 Total Running Current

- 1 When the outdoor unit total running current (AC) exceeds X value, the frequency instructed for compressor operation will be decreased.
- 2 If the running current does not exceed X value for 5 seconds, the frequency instructed will be increased.
- 3 However, if total outdoor unit running current exceeds Y value, compressor will be stopped immediately for 3 minutes.

Model	Z20XKE		Z25XKE		Z35XKE		Z42XKE	
Operation Mode	X (A)	Y (A)	X (A)	Y (A)	X (A)	Y (A)	X (A)	Y (A)
Cooling / Soft Dry (A)	4.25	15.03	5.13	15.03	6.34	14.66	7.78	14.66
Cooling / Soft Dry (B)	3.74		4.69		5.88		6.88	
Cooling / Soft Dry (C)	3.74		4.69		5.88		6.88	
Heating	4.11		4.99		5.79		7.60	

- 4 The first 30 minutes of cooling operation, (A) will be applied.

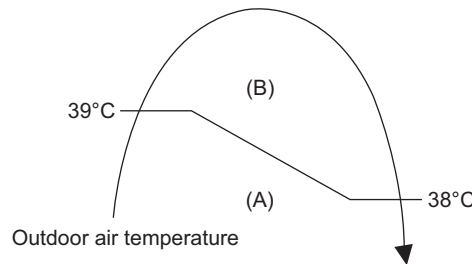

16.1.3 IPM (Power transistor) Prevention Control

- Overheating Prevention Control
 - 1 When the IPM temperature rises to 120°C, compressor operation will stop immediately.
 - 2 Compressor operation restarts after 3 minutes the temperature decreases to 110°C.
 - 3 If this condition repeats continuously 4 times within 20 minutes, timer LED will be blinking ("F96" is indicated).
- DC Peak Current Control
 - 1 When electric current to IPM exceeds set value of 16.0 ± 2.0A (Z20/25/35/42VK) and 30.0 ± 3.0A (Z50/71VK), the compressor will stop operate. Then, operation will restart after 3 minutes.
 - 2 If the set value is exceeded again more than 30 seconds after the compressor starts, the operation will restart after 1 minute.
 - 3 If the set value exceeded again within 30 seconds after the compressor starts, the operation will restart after 1 minute. If this condition repeats continuously for 7 times, all indoor and outdoor relays will be cut off, timer LED will be blinking ("F99" is indicated).

16.1.4 Compressor Overheating Prevention Control

- Instructed frequency for compressor operation will be regulated by compressor temperature. The changes of frequency are as below.
- If compressor temperature exceeds 103°C, compressor will be stopped, occurs 4 times per 20 minutes, timer LED will be blinking. ("F97" is indicated.)

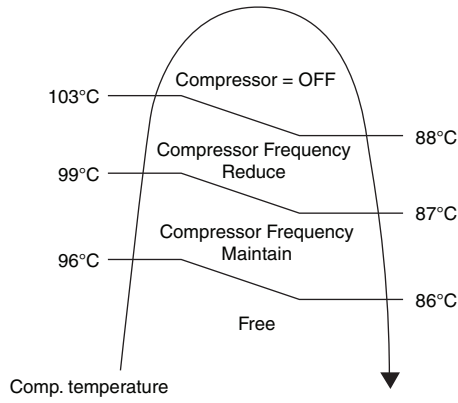

16.1.5 Low Pressure Prevention Control (Gas Leakage Detection)

- Control start conditions
 - For 5 minutes, the compressor continuously operates and outdoor total current is between 0.36A and 0.54A (Z35/42/50/71XKEW), between 0.29A and 0.44A (Z20/25XKEW).
 - During Cooling and Soft Dry operations:
Indoor suction temperature - indoor piping temperature is below 4°C.
 - During Heating operations :
Indoor piping temperature - indoor suction is under 5°C.
- Control contents
 - Compressor stops (and restart after 3 minutes).
 - If the conditions above happen 2 times within 20 minutes, the unit will:
 - Stop operation
 - Timer LED blinks and “F91” indicated.

16.1.6 Low Frequency Protection Control 1

- When the compressor operate at frequency lower than 24 Hz continued for 240 minutes, the operation frequency will be changed to 23 Hz for 2 minutes.

16.1.7 Low Frequency Protection Control 2

- When all the below conditions comply, the compressor frequency will change to lower frequency.

Temperature, T, for:	Cooling/Soft Dry	Heating
Indoor intake air (°C)	T < 14 or T ≥ 30	T < 14 or T ≥ 28
Outdoor air (°C)	T < 13 or T ≥ 38	T < 4 or T ≥ 24
Indoor heat exchanger (°C)	T < 30	T ≥ 0

16.2 Protection Control for Cooling & Soft Dry Operation

16.2.1 Outdoor Air Temperature Control

- The compressor operating frequency is regulated in accordance to the outdoor air temperature as shown in the diagram below.
- This control will begin 1 minute after the compressor starts.
- Compressor frequency will adjust base on outdoor air temperature.

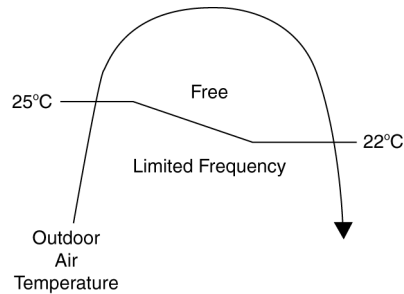

- The compressor will be stopped to avoid compressor overloading.

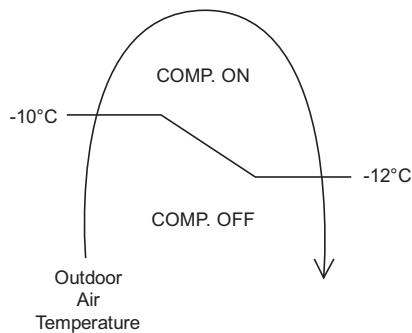

16.2.2 Cooling Overload Control

- Detects the Outdoor pipe temperature and carry out below restriction/limitation (Limit the compressor Operation frequency).
- The compressor stop if outdoor pipe temperature exceeds 60°C.
- If the compressor stops 4 times in 20 minutes, Timer LED blinking (F95 indicated: outdoor high pressure rise protection).

16.2.3 Freeze Prevention Control 1

- When indoor heat exchanger temperature is lower than 0°C continuously for 6 minutes, compressor will stop operating.
- Compressor will resume its operation 3 minutes after the indoor heat exchanger is higher than 5°C.
- At the same time, indoor fan speed will be higher than during its normal operation.
- If indoor heat exchanger temperature is higher than 13°C, the fan speed will return to its normal operation.

16.2.4 Freeze Prevention Control 2

- Control start conditions
 - During Cooling operation and soft dry operation
 - During thermo OFF condition, indoor intake temperature is less than 10°C or
 - Compressor stops for freeze prevention control
 - Either one of the conditions above occurs 5 times in 60 minutes.
- Control contents
 - Operation stops
 - Timer LED blinks and "H99" indicated

16.2.5 Dew Prevention Control 1

- To prevent dew formation at indoor unit discharge area.
- This control will be activated if:
 - Outdoor air temperature and Indoor pipe temperature judgment by microcontroller is fulfilled.
 - When Cooling or Dry mode is operated more than 20 minutes or more.
- This control stopped if:
 - Compressor stopped.
 - Remote control setting changed (fan speed / temperature).
 - Outdoor air temperature and indoor intake temperature changed.
- Fan speed will be adjusted accordingly in this control.

16.2.6 Odor Cut Control

- To reduce the odor released from the unit.
 - Start Condition
 - AUTO FAN Speed is selected during COOL or DRY operation.
 - During freeze prevention control and timer preliminary operation, this control is not applicable.
 - Control content
 - Depends on compressor conditions:
 1. Compressor OFF → Compressor ON.
The indoor unit fan stops temporarily and then starts to blow at minimum airflow for 30 seconds.
 2. Compressor ON → Compressor OFF.
The indoor unit fan stops for 90 seconds and then blows at minimum airflow for 20 seconds.

16.3 Protection Control for Heating Operation

16.3.1 Intake Air Temperature Control

Compressor will operate at limited freq., if indoor intake air temperature is 30°C or above.

16.3.2 Outdoor Air Temperature Control

- The Max current value is regulated when the outdoor air temperature rise above 14°C in order to avoid compressor overloading.

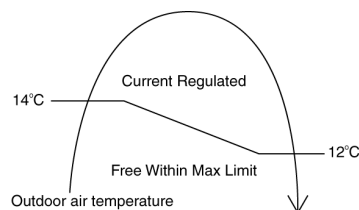

16.3.3 Overload Protection Control

- The compressor operating frequency is regulated in accordance to indoor heat exchanger temperature as shown below.
- If the heat exchanger temperature exceeds 60°C, compressor will stop.

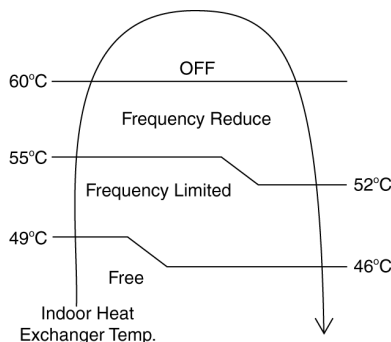

16.3.4 Low Temperature Compressor Oil Return Control

- In heating operation, if the outdoor temperature falls below -10°C when compressor starts, the compressor frequency will be regulated up to 600 seconds.

16.3.5 Cold Draught Prevention Control

- When indoor pipe temperature is low, cold draught operation starts where indoor fan speed will be reduced.

16.3.6 Deice Operation

- When outdoor pipe temperature and outdoor air temperature is low, deice operation start where indoor fan motor and outdoor fan motor stop and operation LED blinks.

16.3.7 Low Pressure Protection Control

- During low ambient heating operation, if the pipe temperature drops below -22°C , the max frequency will be reduced and limited.
- If it does not rises after 3 minutes, the compressor will stop.
- The compressor will start again if the pipe temperature rises above -18°C .

17. Servicing Mode

17.1 Auto OFF/ON Button

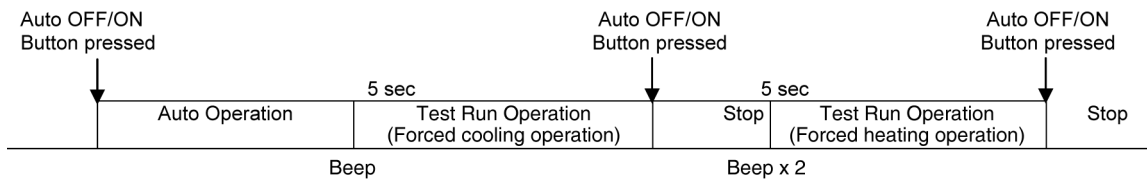

1 AUTO OPERATION MODE

The Auto operation will be activated immediately once the Auto OFF/ON button is pressed. This operation can be used to operate air conditioner with limited function if remote control is misplaced or malfunction.

2 TEST RUN OPERATION (FOR PUMP DOWN/SERVICING PURPOSE)

The Test Run operation will be activated if the Auto OFF/ON button is pressed continuously for more than 5 seconds. A “beep” sound will heard at the fifth seconds, in order to identify the starting of Test Run operation (Forced cooling operation). Within 5 minutes after Forced cooling operation start, the Auto OFF/ON button is pressed for more than 5 seconds. A 2 “beep” sounds will heard at the fifth seconds, in order to identify the starting of Forced heating operation.

The Auto OFF/ON button may be used together with remote control to set / change the advance setting of air conditioner operation.

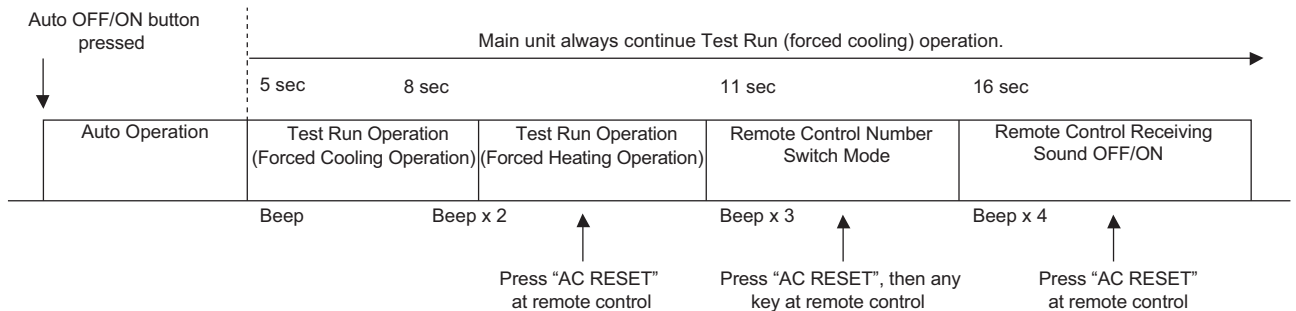

3 REMOTE CONTROL NUMBER SWITCH MODE

The Remote Control Number Switch Mode will be activated if the Auto OFF/ON button is pressed continuously for more than 11 seconds (3 “beep” sounds will occur at 11th seconds to identify the Remote Control Number Switch Mode is in standby condition) and press “AC RESET” button and then press any button at remote control to transmit and store the desired transmission code to the EEPROM.

There are 4 types of remote control transmission code could be selected and stored in EEPROM of indoor unit. The indoor unit will only operate when received signal with same transmission code from remote control. This could prevent signal interference when there are 2 or more indoor units installed nearby together. To change remote control transmission code, short or open jumpers at the remote control printed circuit board.

JA	Remote Control Printed Circuit Board			JB
	Jumper A (J-A)	Jumper B (J-B)	Remote Control No.	
	Short	Open	A (Default)	
	Open	Open	B	
	Short	Short	C	
	Open	Short	D	

- During Remote Control Number Switch Mode, press any button at remote control to transmit and store the transmission code to the EEPROM.

4 REMOTE CONTROL RECEIVING SOUND OFF/ON MODE

The Remote Control Receiving Sound OFF/ON Mode will be activated if the Auto OFF/ON button is pressed continuously for more than 16 seconds (4 “beep” sounds will occur at 16th seconds to identify the Remote Control Receiving Sound Off/On Mode is in standby condition) and press “AC Reset” button at remote control.





Press “Auto OFF/ON button” to toggle remote control receiving sound.

- a) Short “beep”: Turn OFF remote control receiving sound.
- b) Long “beep”: Turn ON remote control receiving sound.

After Auto OFF/ON Button is pressed, the 20 seconds counter for Remote Control Receiving Sound OFF/ON Mode is restarted.

17.2 Heat Only Operation

17.2.1 How to Activate/Deactivate Heat only Operation

- Use remote controller to set heating only operation. When the unit in standby mode, follow the steps below:
 - a) Press  continuously for more than 5 seconds to enter special setting mode.
 - b) Press  to choose function 61, and then press  or  to set “01”. (To enable the “Heat Only” mode) or “00” (To disable the “Heat Only” mode).
 - c) Press  to activate “Heating only operation” or deactivate “Heating only operation”.

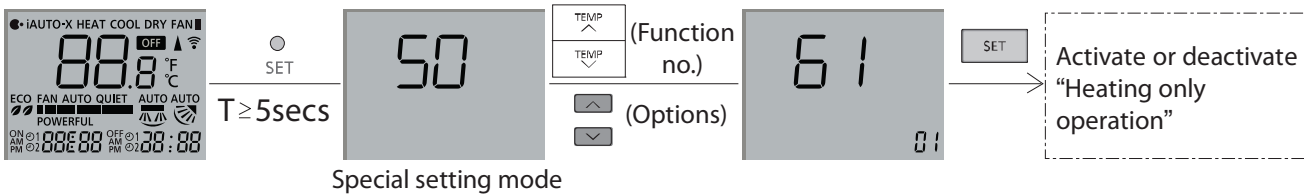

17.2.2 Operation mode during Heating Only Operation

- The table below shows the operation mode comparison when Heating Only Operation Mode Activated and Deactivated.

Operation Mode	Heating Only Operation Mode Activated	Heating Only Operation Mode Deactivated
AUTO	After 30s sampling, regardless of the indoor intake or outdoor intake temperature judgment, the unit will run Heating operation.	After 30s sampling, the unit will judge the operation mode base on remote controller temperature setting and Indoor Intake Sensor (New Auto Mode) or Outdoor Intake Sensor (Old Auto Mode).
HEAT	The unit will run Heating operation.	The unit will run Heating operation.
COOL	The unit will stop and Power LED blinking.	The unit will run Cooling operation.
DRY	The unit will stop and Power LED blinking.	The unit will run Cooling Dry operation.
NANOE Stand-alone	The unit will stop and Power LED blinking.	The unit will run Nanoe Stand-alone operation.
Force Cooling	The unit will run Force Cooling Operation for X_CTRYTM [15] minutes	The unit will run Force Cooling operation.
Force Heating	The unit will run Force Heating operation.	The unit will run Force Heating operation.
AUTO (with Timer)	The unit will turn ON by the timer and run Auto Operation. After 30s sampling, regardless of the indoor intake or outdoor intake temperature judgment, the unit will run Heating operation.	The unit will turn ON by the timer and run Auto Operation. After 30s sampling, the unit will judge the operation mode base on remote controller temperature setting and Indoor Intake Sensor (New Auto Mode) or Outdoor Intake Sensor (Old Auto Mode).
HEAT (with Timer)	The unit will turn ON by the timer and run Heating Operation.	The unit will turn ON by the timer and run Heating Operation.
COOL (with Timer)	The unit will not turn ON by the timer. Power LED blinking.	The unit will turn ON by the timer and run Cooling Operation.
DRY (with Timer)	The unit will not turn ON by the timer. Power LED blinking.	The unit will turn ON by the timer and run Cooling Dry Operation.
Cooling Test Mode	The unit will stop and Power LED blinking.	The unit will operate according to specify Cooling test mode operation parameter.
Heating Test Mode	The unit will operate according to specify Heating test mode operation parameter.	The unit will operate according to specify Heating test mode operation parameter.



17.3 Remote Control Button

17.3.1 SET Button

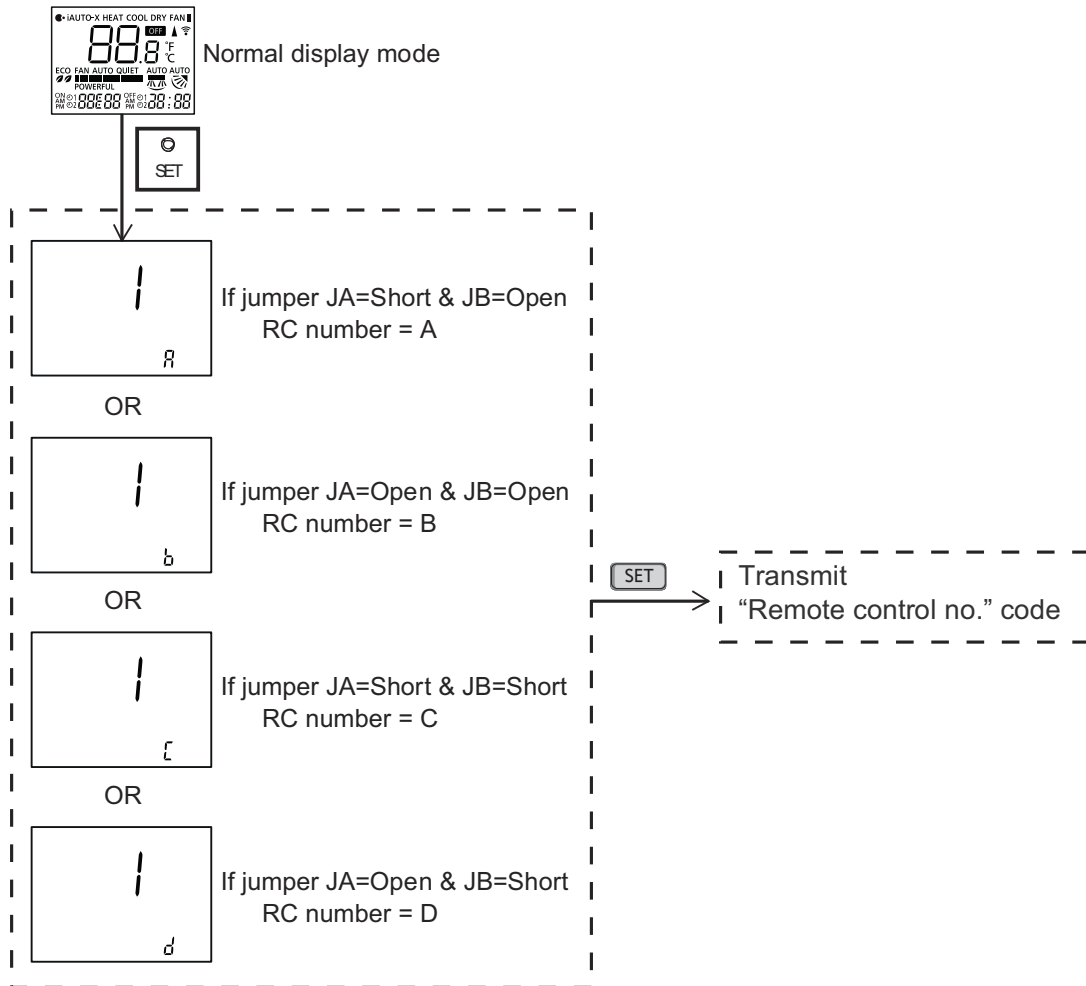
- To check remote control transmission code and store the transmission code to EEPROM.
 - Press "Set" button by using pointer.
 - Press "Timer Set" button until a "beep" sound is heard as confirmation of transmission code change.
 - LCD returns to original display if remote control does not operate for 30 seconds.



- Press **CANCEL** SW, special setting is immediately cancelled and normal mode starts.
- If no SW is pressed for 30 secs, then special setting mode is cancelled and normal mode starts.

- Under this function, only **TEMP**  **TEMP** , **SET**, **CANCEL** and **RC**  SW's are effective.

- To limit set temperature range for COOL & DRY, HEAT, AUTO mode.
 - Press "Set" button by using pointer.
 - Press TEMP increment or decrement button to choose No. 3.
 - Press Timer increment or decrement button to select desired temperature low limit of set temperature for COOL & DRY mode.

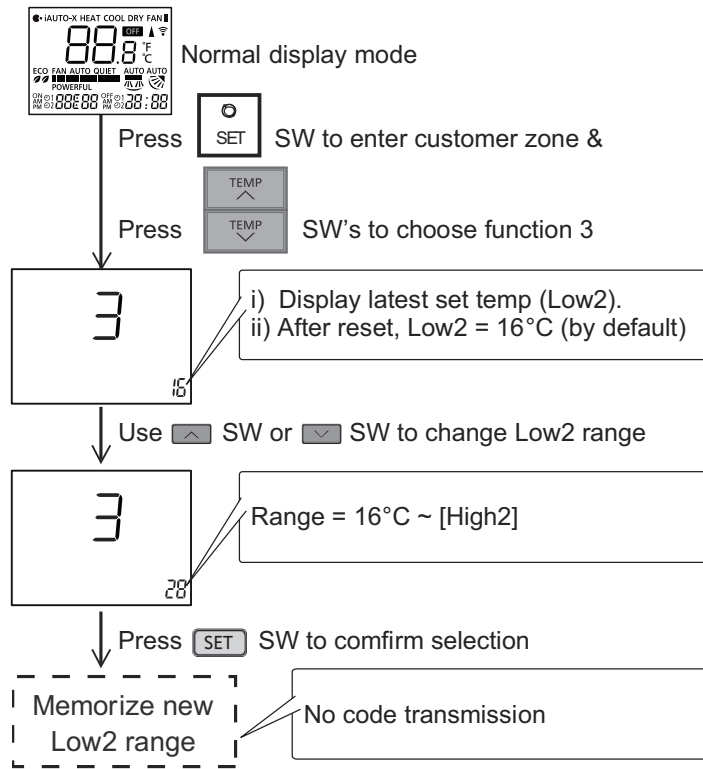

- Press Timer Set button to confirm low limit selection.
- Press TEMP increment or decrement button to choose No. 4.
- Press Timer decrement or increment button to select desired temperature high limit of set temperature for COOL & DRY mode.

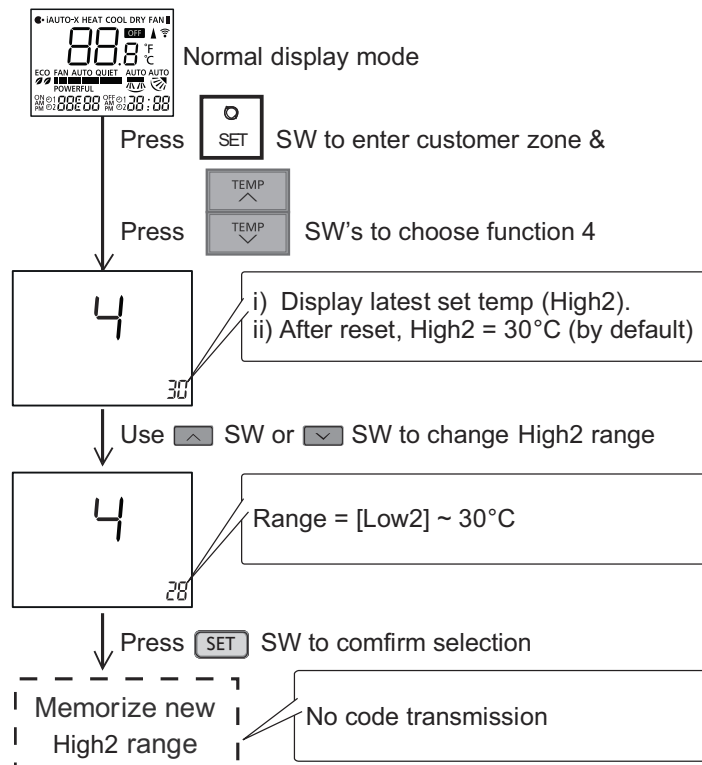

- Press Timer Set button to confirm high limit selection.

- Press TEMP increment or decrement button to choose No. 5.
- Press Timer increment or decrement button to select desired temperature low limit of set temperature for HEAT mode.

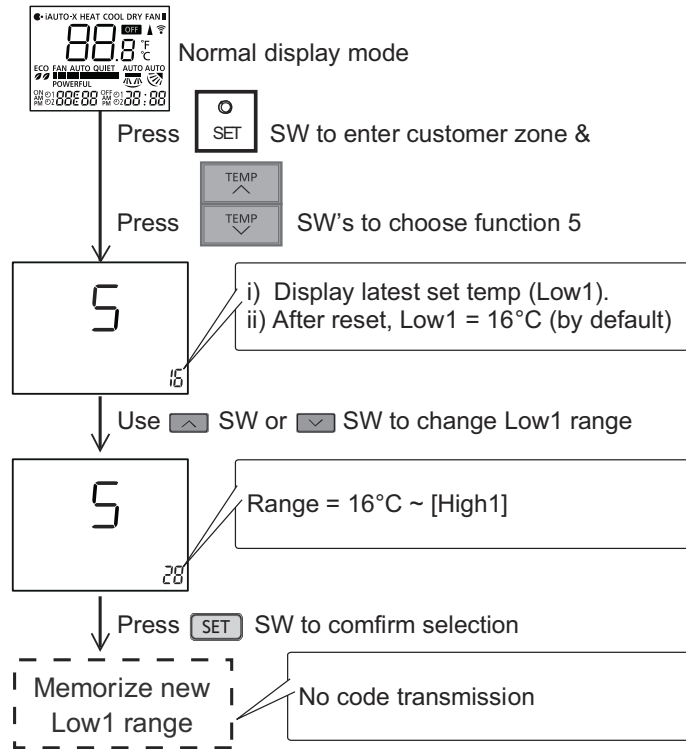

- Press Timer Set button to confirm low limit selection.
- Press TEMP increment or decrement button to choose No. 6.
- Press Timer decrement or increment button to select desired temperature high limit of set temperature for HEAT mode.

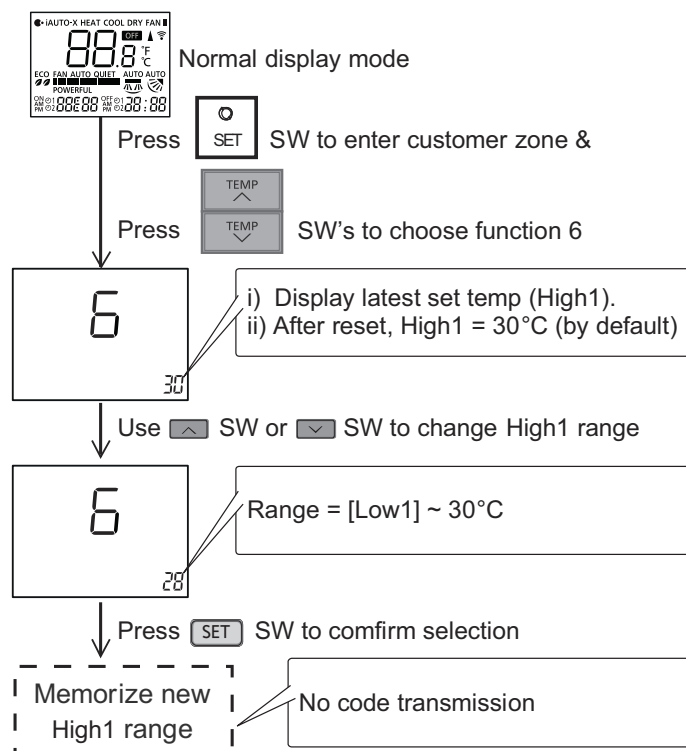

- Press Timer Set button to confirm high limit selection.

- Press TEMP increment or decrement button to choose No. 12.
- Press Timer increment or decrement button to select desired temperature low limit of set temperature for AUTO mode.

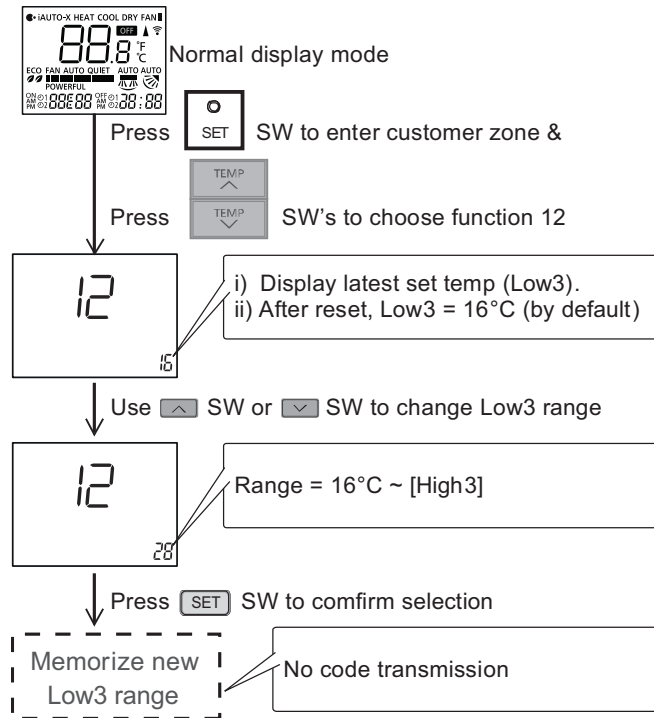

- Press Timer Set button to confirm low limit selection.
- Press TEMP increment or decrement button to choose No. 13.
- Press Timer decrement or increment button to select desired temperature high limit of set temperature for AUTO mode.

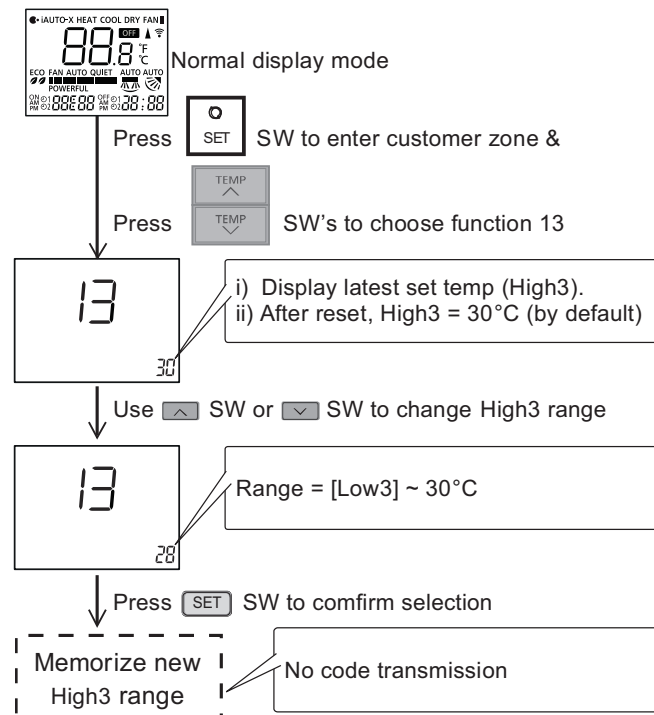

- Press Timer Set button to confirm high limit selection.
- LCD returns to original display if remote control does not operate for 30 seconds or press Timer Cancel button.

17.3.2 RESET (RC)

- To clear and restore the remote control setting to factory default.
 - Press once to clear the memory

17.3.3 RESET (AC)

- To restore the unit's setting to factory default.
 - Press once to restore the unit's setting.

17.3.4 TIMER

- To change indoor unit indicators' intensity:
 - Press continuously for 5 seconds.

17.3.5 TIMER

- To change remote control display from Degree Celsius (°C) to Degree Fahrenheit (°F).
 - Press continuously for 10 seconds.

17.3.6 Customization mode

1 LCD display area:

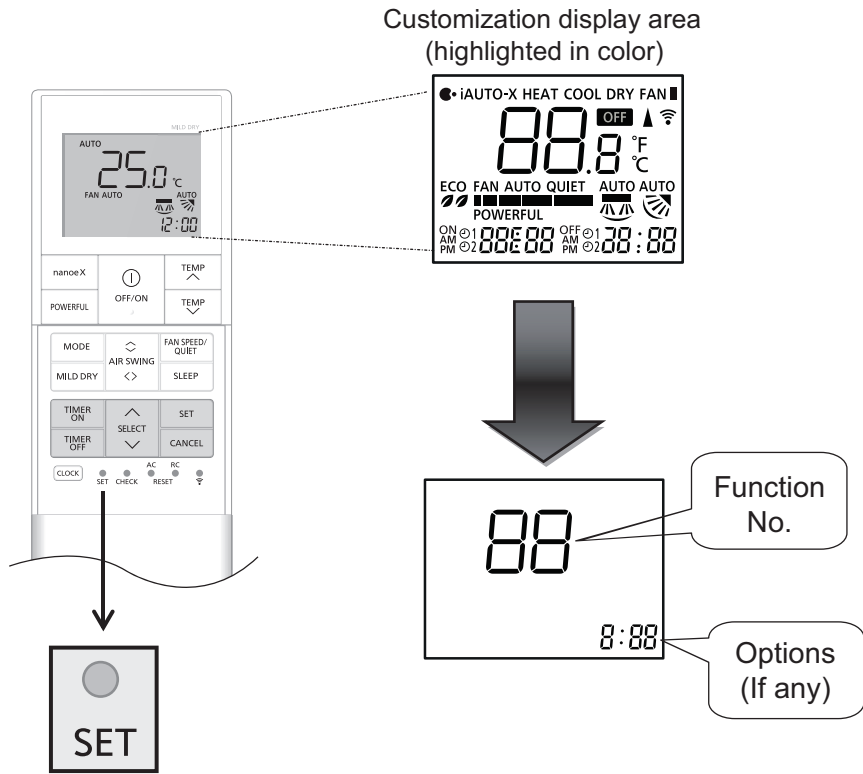

2 Cannot enter this customization mode under the following conditions:

- ① Operation ON.
- ② Under [Real/ON/OFF] time setting mode.

3 To enter Customer zone:

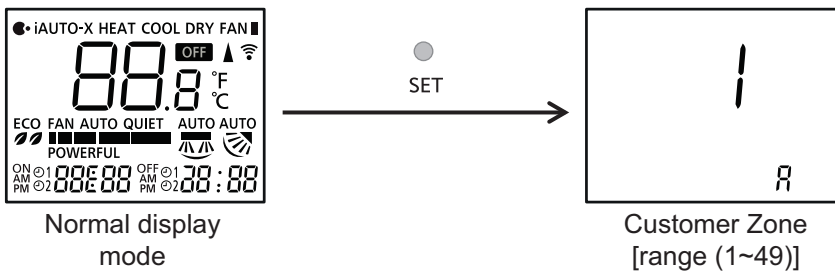

4 To enter Service zone: (Press SET continuously for T ≥ 5 secs)

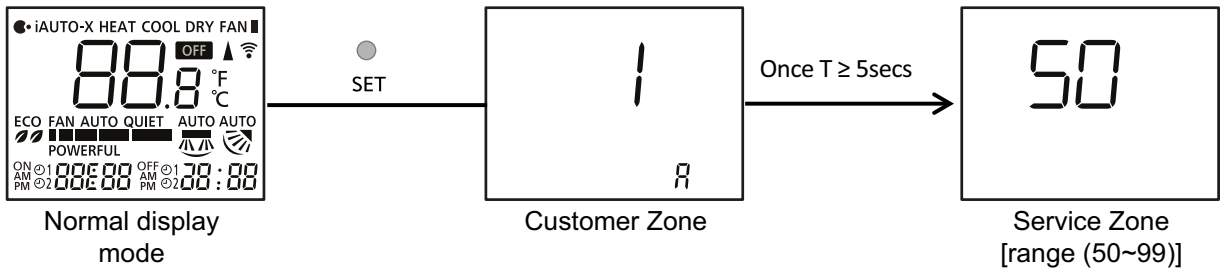

5 Function & Options list:

Note: The functions described in the table may not be applicable to the model and may subject to change without further notice.

		Customization		Options	Remark
No	Name				
Customer Zone	1	Remote control number selection		A, B, C, D	
	2	Solar radiation sensitivity level adjustment		1, 2, 3, 4, 5	
	3	[iAUTO-X/iAUTO/iCOMF, Cool & Dry] mode set temperature [Low2] selection		16°C ~ [High2]	
	4	[iAUTO-X/iAUTO/iCOMF, Cool & Dry] mode set temperature [High2] selection		[Low2] ~ 30°C	
	5	Heat mode set temperature Low1 selection		16°C ~ [High1]	
	6	Heat mode set temperature High1 selection		[Low1] ~ 30°C	
	7	Filter cleaning selection		00 – Disable 01 – Enable	
	8	nanoe/nanoe-G default ON selection		00 – Disable 01 – Enable	
	9	Dust sensor monitoring & LED selection		00 – Disable 01 – Enable	
	10	Auto restart selection		00 – Disable 01 – Enable	
	11	Dust sensor sensitivity level adjustment		1, 2, 3	
	12	Auto mode set temperature Low3 selection		16°C ~ [High3]	
	13	Auto mode set temperature High3 selection		[Low3] ~ 30°C	
	14	Indoor unit installation position selection		ct – Center lt – Left rt – Right	
	15	ECO status memorize selection		00 – Disable 01 – Enable	
16 ~ 49	Reserve				
Service Zone	50	ECO demo ON		None (No display)	
	51	Light sensor check		None (No display)	
	52	nanoe-G / ECO sensor check		None (No display)	
	53	DOA check		None (No display)	
	54	Odor cut control selection		00 – Disable 01 – Enable	
	55	Frequency tolerance selection		03 – ±3Hz 07 – ±7Hz	
	56	Fixed fan speed selection during heat mode compressor OFF		00 – Disable 01 – Enable	
	57	nanoe check		None (No display)	
	58	Heat mode thermo shift adjustment		-3°C ~ 3°C	
	59	Others (Cool & Dry) mode thermo shift adjustment		-3°C ~ 3°C	
	60	Deice start determination judgment temperature switching		00 – No 01 – Yes	
	61	Cool mode disable selection		00 – No 01 – Yes	
	62	Heat mode disable selection		00 – No 01 – Yes	
	63	Base pan heater selection		A – Base pan A b – Base pan B	
64	Disable fan speed reduction during cool mode thermo-Off		00 – No 01 – Yes		
65	LED smart OFF selection		00 – Disable 01 – Enable		
66	nanoe-G ON/OFF duration selection		01 – Pattern 1 02 – Pattern 2 03 – Pattern 3 04 – Pattern 4		
67	Operation OFF deice function selection		00 – Disable 01 – Enable		

		Customization		Options	Remark
		No	Name		
Service Zone	68	Compressor frequency change speed selection		01 – Pattern 1 02 – Pattern 2 03 – Pattern 3	
	69	Up/Down air swing upper limit restriction selection		00 – Disable 01 – Enable	
	70	Failure diagnosis mode disable		None (No display)	
	71	Compressor Fhmax setting selection		01 – Offset 1 02 – Offset 2 03 – Offset 3	
	72	Compressor Max Fc setting selection		00 – Disable 01 – Enable	
	73 ~ 99	Reserve			

18. Troubleshooting Guide

18.1 Refrigeration Cycle System

In order to diagnose malfunctions, make sure that there are no electrical problems before inspecting the refrigeration cycle. Such problems include insufficient insulation, problem with the power source, malfunction of a compressor and a fan. The normal outlet air temperature and pressure of the refrigeration cycle depends on various conditions, the standard values for them are shown in the table on the right.

Normal Pressure and Outlet Air Temperature (Standard)

	Gas Pressure MPa (kg/cm ² G)	Outlet air Temperature (°C)
Cooling Mode	0.9 ~ 1.2 (9 ~ 12)	13 ~ 17
Heating Mode	2.0 ~ 2.7 (20 ~ 27)	32 ~ 42

- *Condition:
- Indoor fan speed = High
 - Outdoor temperature 35°C at the cooling mode and 7°C at the heating mode
 - Compressor operates at rated frequency

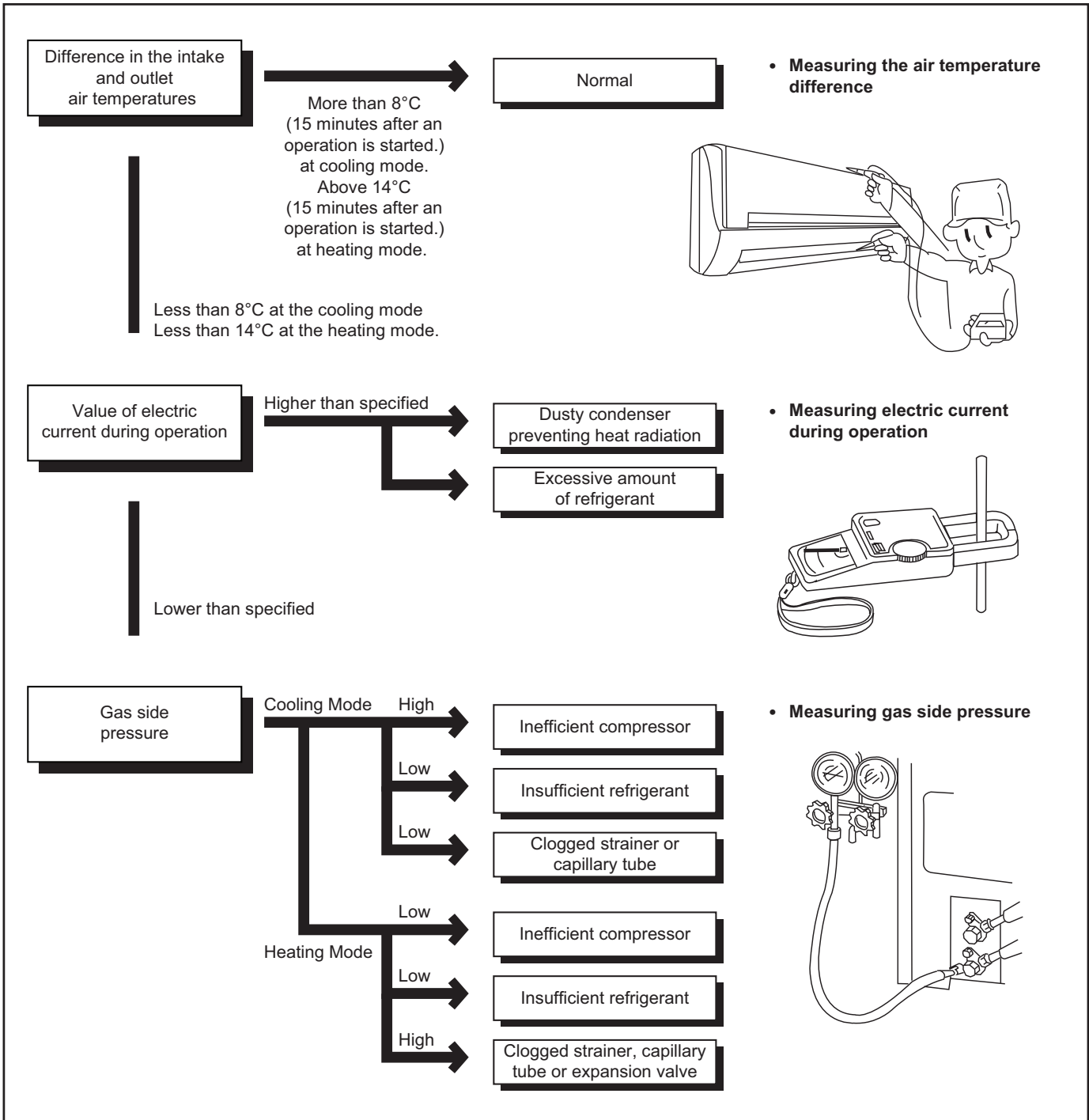

18.1.1 Relationship Between the Condition of the Air Conditioner and Pressure and Electric Current

Condition of the air conditioner	Cooling Mode			Heating Mode		
	Low Pressure	High Pressure	Electric current during operation	Low Pressure	High Pressure	Electric current during operation
Insufficient refrigerant (gas leakage)	↘	↘	↘	↘	↘	↘
Clogged capillary tube or Strainer	↘	↘	↘	↗	↗	↗
Short circuit in the indoor unit	↘	↘	↘	↗	↗	↗
Heat radiation deficiency of the outdoor unit	↗	↗	↗	↘	↘	↘
Inefficient compression	↗	↘	↘	↗	↘	↘





- Carry out the measurement of pressure, electric current, and temperature fifteen minutes after an operation is started.

18.2 Breakdown Self Diagnosis Function

18.2.1 Self Diagnosis Function (Three Digits Alphanumeric Code)





- Once abnormality has occurred during operation, the unit will stop its operation, and Timer LED blinks.
- Although Timer LED goes off when power supply is turned off, if the unit is operated under a breakdown condition, the LED will light up again.
- In operation after breakdown repair, the Timer LED will no more blink. The last error code (abnormality) will be stored in IC memory.

18.2.2 To Make a Diagnosis

- 1 Timer LED start to blink and the unit automatically stops the operation.
- 2 Press the CHECK button on the remote controller continuously for 5 seconds.
- 3 “- -” will be displayed on the remote controller display.
Note: Display only for “- -”. (No transmitting signal, no receiving sound and no Power LED blinking.)
- 4 Press the “TIMER”  or  button on the remote controller. The code “H00” (no abnormality) will be displayed and signal will be transmitted to the main unit.
- 5 Each press of the button ( or ) will increase error code number and transmit error code signal to the main unit.
- 6 When the latest abnormality code on the main unit and code transmitted from the remote controller are matched, power LED will light up for 30 seconds and a beep sound (continuously for 4 seconds) will be heard. If no codes are matched, power LED will light up for 0.5 seconds and no sound will be heard.
- 7 The breakdown diagnosis mode will be canceled unless pressing the CHECK button continuously for 5 seconds or operating the unit for 30 seconds.
- 8 The LED will be off if the unit is turned off or the RESET button on the main unit is pressed.



18.2.3 To Display Memorized Error (Protective Operation) Status

- 1 Turn power on.
- 2 Press the CHECK button on the remote controller continuously for 5 seconds
- 3 “- -” will be displayed on the remote controller display.
Note: Display only for “- -”. (No transmitting signal, no receiving sound and no Power LED blinking.)
- 4 Press the “TIMER”  or  button on the remote controller. The code “H00” (no abnormality) will be displayed and signal will be transmitted to the main unit.
The power LED lights up. If no abnormality is stored in the memory, three beeps sound will be heard.
- 5 Each press of the button ( or ) will increase error code number and transmit error code signal to the main unit.
- 6 When the latest abnormality code on the main unit and code transmitted from the remote controller are matched, power LED will light up for 30 seconds and a beep sound (continuously for 4 seconds) will be heard. If no codes are matched, power LED will light up for 0.5 seconds and no sound will be heard.
- 7 The breakdown diagnosis mode will be canceled unless pressing the CHECK button continuously for 5 seconds or operating the unit for 30 seconds.
- 8 The same diagnosis can be repeated by turning power on again.

18.2.4 To Clear Memorized Error (Protective Operation) Status after Repair:

- 1 Turn power on (in standby condition).
- 2 Press the AUTO button for 5 seconds (A beep receiving sound) on the main unit to operate the unit at Forced Cooling Operation modes.
- 3 Press the CHECK button on the remote controller for about 1 second with a pointed object to transmit signal to main unit. A beep sound is heard from main unit and the data is cleared.

18.2.5 Temporary Operation (Depending On Breakdown Status)

- 1 Press the AUTO button (A beep receiving sound) on the main unit to operate the unit. (Remote control will become possible.)
- 2 The unit can temporarily be used until repaired.

18.3 Error Codes Table

Diagnosis display	Abnormality / Protection control	Abnormality Judgment	Protection Operation	Problem	Check location
H00	No memory of failure	—	Normal operation	—	—
H11	Indoor/outdoor abnormal communication	After operation for 1 minute	Indoor fan only operation can start by entering into force cooling operation	Indoor/outdoor communication not establish	<ul style="list-style-type: none"> Indoor/outdoor wire terminal Indoor/outdoor PCB Indoor/outdoor connection wire
H12	Indoor unit capacity unmatched	90s after power supply	—	Total indoor capability more than maximum limit or less than minimum limit, or number of indoor unit less than two	<ul style="list-style-type: none"> Indoor/outdoor connection wire Indoor/outdoor PCB Specification and combination table in catalogue
H14	Indoor intake air temperature sensor abnormality	Continuous for 5s	—	Indoor intake air temperature sensor open or short circuit	<ul style="list-style-type: none"> Indoor intake air temperature sensor lead wire and connector
H15	Compressor temperature sensor abnormality	Continuous for 5s	—	Compressor temperature sensor open or short circuit	<ul style="list-style-type: none"> Compressor temperature sensor lead wire and connector
H16	Outdoor current transformer (CT) abnormality	—	—	Current transformer faulty or compressor faulty	<ul style="list-style-type: none"> Outdoor PCB faulty or compressor faulty
H19	Indoor fan motor mechanism lock	Continuous happen for 7 times	—	Indoor fan motor lock or feedback abnormal	<ul style="list-style-type: none"> Fan motor lead wire and connector Fan motor lock or block
H23	Indoor heat exchanger temperature sensor abnormality	Continuous for 5s	—	Indoor heat exchanger temperature sensor open or short circuit	<ul style="list-style-type: none"> Indoor heat exchanger temperature sensor lead wire and connector
H24	Indoor heat exchanger temperature sensor 2 abnormality	Continuous for 5s	—	Indoor heat exchanger temperature sensor 2 open or short circuit	<ul style="list-style-type: none"> Indoor heat exchanger temperature sensor 2 lead wire and connector
H25	Indoor ion device abnormality	Port is ON for 10s during ion device off	—	—	<ul style="list-style-type: none"> ion device PCB
H27	Outdoor air temperature sensor abnormality	Continuous for 5s	—	Outdoor air temperature sensor open or short circuit	<ul style="list-style-type: none"> Outdoor air temperature sensor lead wire and connector
H28	Outdoor heat exchanger temperature sensor 1 abnormality	Continuous for 5s	—	Outdoor heat exchanger temperature sensor 1 open or short circuit	<ul style="list-style-type: none"> Outdoor heat exchanger temperature sensor 1 lead wire and connector
H30	Outdoor discharge pipe temperature sensor abnormality	Continuous for 5s	—	Outdoor discharge pipe temperature sensor open or short circuit	<ul style="list-style-type: none"> Outdoor discharge pipe temperature sensor lead wire and connector
H32	Outdoor heat exchanger temperature sensor 2 abnormality	Continuous for 5s	—	Outdoor heat exchanger temperature sensor 2 open or short circuit	<ul style="list-style-type: none"> Outdoor heat exchanger temperature sensor 2 lead wire and connector
H33	Indoor / outdoor misconnection abnormality	—	—	Indoor and outdoor rated voltage different	<ul style="list-style-type: none"> Indoor and outdoor units check
H34	Outdoor heat sink temperature sensor abnormality	Continuous for 2s	—	Outdoor heat sink temperature sensor open or short circuit	<ul style="list-style-type: none"> Outdoor heat sink sensor
H36	Outdoor gas pipe temperature sensor abnormality	Continuous for 5s	Heating protection operation only	Outdoor gas pipe temperature sensor open or short circuit	<ul style="list-style-type: none"> Outdoor gas pipe temperature sensor lead wire and connector
H37	Outdoor liquid pipe temperature sensor abnormality	Continuous for 5s	Cooling protection operation only	Outdoor liquid pipe temperature sensor open or short circuit	<ul style="list-style-type: none"> Outdoor liquid pipe temperature sensor lead wire and connector
H38	Indoor/Outdoor mismatch (brand code)	—	—	Brand code not match	<ul style="list-style-type: none"> Check indoor unit and outdoor unit
H39	Abnormal indoor operating unit or standby units	3 times happen within 40 minutes	—	Wrong wiring and connecting pipe, expansion valve abnormality, indoor heat exchanger sensor open circuit	<ul style="list-style-type: none"> Check indoor/outdoor connection wire and connection pipe Indoor heat exchanger sensor lead wire and connector Expansion valve and lead wire and connector

Diagnosis display	Abnormality / Protection control	Abnormality Judgment	Protection Operation	Problem	Check location
H41	Abnormal wiring or piping connection	—	—	Wrong wiring and connecting pipe, expansion valve abnormality	<ul style="list-style-type: none"> • Check indoor/outdoor connection wire and connection pipe • Expansion valve and lead wire and connector
H59	ECONAVI sensor abnormality	Continuous for 25s	—	ECONAVI sensor open or short circuit	<ul style="list-style-type: none"> • ECONAVI sensor (defective or disconnected) • ECONAVI PCB
H64	Outdoor high pressure sensor abnormality	Continuous for 1 minutes	—	High pressure sensor open circuit during compressor stop	<ul style="list-style-type: none"> • High pressure sensor • Lead wire and connector
H67	Nanoe abnormality	Nanoe stop for 5 minutes for 3 times	—	Nanoe faulty	<ul style="list-style-type: none"> • PCB • Nanoe system • High voltage
H70	Light sensor abnormality	Continuous for 24 hours, 15 days	—	Light sensor open or short circuit	<ul style="list-style-type: none"> • Light sensor (defective or disconnect)
H85	Abnormal communication between indoor & wireless LAN module	Communication error for 10 minutes for 3 times	—	Wireless LAN LED Off or timer LED blinking	<ul style="list-style-type: none"> • Network adaptor • Router • Network coverage
H97	Outdoor fan motor mechanism lock	2 times happen within 30 minutes	—	Outdoor fan motor lock or feedback abnormal	<ul style="list-style-type: none"> • Outdoor fan motor lead wire and connector • Fan motor lock or block
H98	Indoor high pressure protection	—	—	Indoor high pressure protection (Heating)	<ul style="list-style-type: none"> • Check indoor heat exchanger • Air filter dirty • Air circulation short circuit
H99	Indoor operating unit freeze protection	—	—	Indoor freeze protection (Cooling)	<ul style="list-style-type: none"> • Check indoor heat exchanger • Air filter dirty • Air circulation short circuit
F11	4-way valve switching abnormality	4 times happen within 30 minutes	—	4-way valve switching abnormal	<ul style="list-style-type: none"> • 4-way valve • Lead wire and connector
F17	Indoor standby units freezing abnormality	3 times happen within 40 minutes	—	Wrong wiring and connecting pipe, expansion valve leakage, indoor heat exchanger sensor open circuit	<ul style="list-style-type: none"> • Check indoor/outdoor connection wire and pipe • Indoor heat exchanger sensor lead wire and connector • Expansion valve lead wire and connector
F90	Power factor correction (PFC) circuit protection	4 times happen within 10 minutes	—	Power factor correction circuit abnormal	<ul style="list-style-type: none"> • Outdoor PCB faulty
F91	Refrigeration cycle abnormality	2 times happen within 20 minutes	—	Refrigeration cycle abnormal	<ul style="list-style-type: none"> • Insufficient refrigerant or valve close
F93	Compressor abnormal revolution	4 times happen within 20 minutes	—	Compressor abnormal revolution	<ul style="list-style-type: none"> • Power transistor module faulty or compressor lock
F94	Compressor discharge overshoot protection	4 times happen within 30 minutes	—	Compressor discharge pressure overshoot	<ul style="list-style-type: none"> • Check refrigeration system
F95	Outdoor cooling high pressure protection	4 times happen within 20 minutes	—	Cooling high pressure protection	<ul style="list-style-type: none"> • Check refrigeration system • Outdoor air circuit
F96	Power transistor module overheating protection	4 times happen within 30 minutes	—	Power transistor module overheat	<ul style="list-style-type: none"> • PCB faulty • Outdoor air circuit (fan motor)
F97	Compressor overheating protection	3 times happen within 30 minutes	—	Compressor overheat	<ul style="list-style-type: none"> • Insufficient refrigerant
F98	Total running current protection	3 times happen within 20 minutes	—	Total current protection	<ul style="list-style-type: none"> • Check refrigeration system • Power source or compressor lock
F99	Outdoor direct current (DC) peak detection	Continuous happen for 7 times	—	Power transistor module current protection	<ul style="list-style-type: none"> • Power transistor module faulty or compressor lock

18.4 Self-diagnosis Method

18.4.1 H11 (Indoor/Outdoor Abnormal Communication)

Malfunction Decision Conditions

- During startup and operation of cooling and heating, the data received from outdoor unit in indoor unit signal transmission is checked whether it is normal.

Malfunction Caused

- Faulty indoor unit PCB.
- Faulty outdoor unit PCB.
- Indoor unit-outdoor unit signal transmission error due to wiring error.
- Indoor unit-outdoor unit signal transmission error due to breaking of wire in the connection wires between the indoor and outdoor units.

Troubleshooting

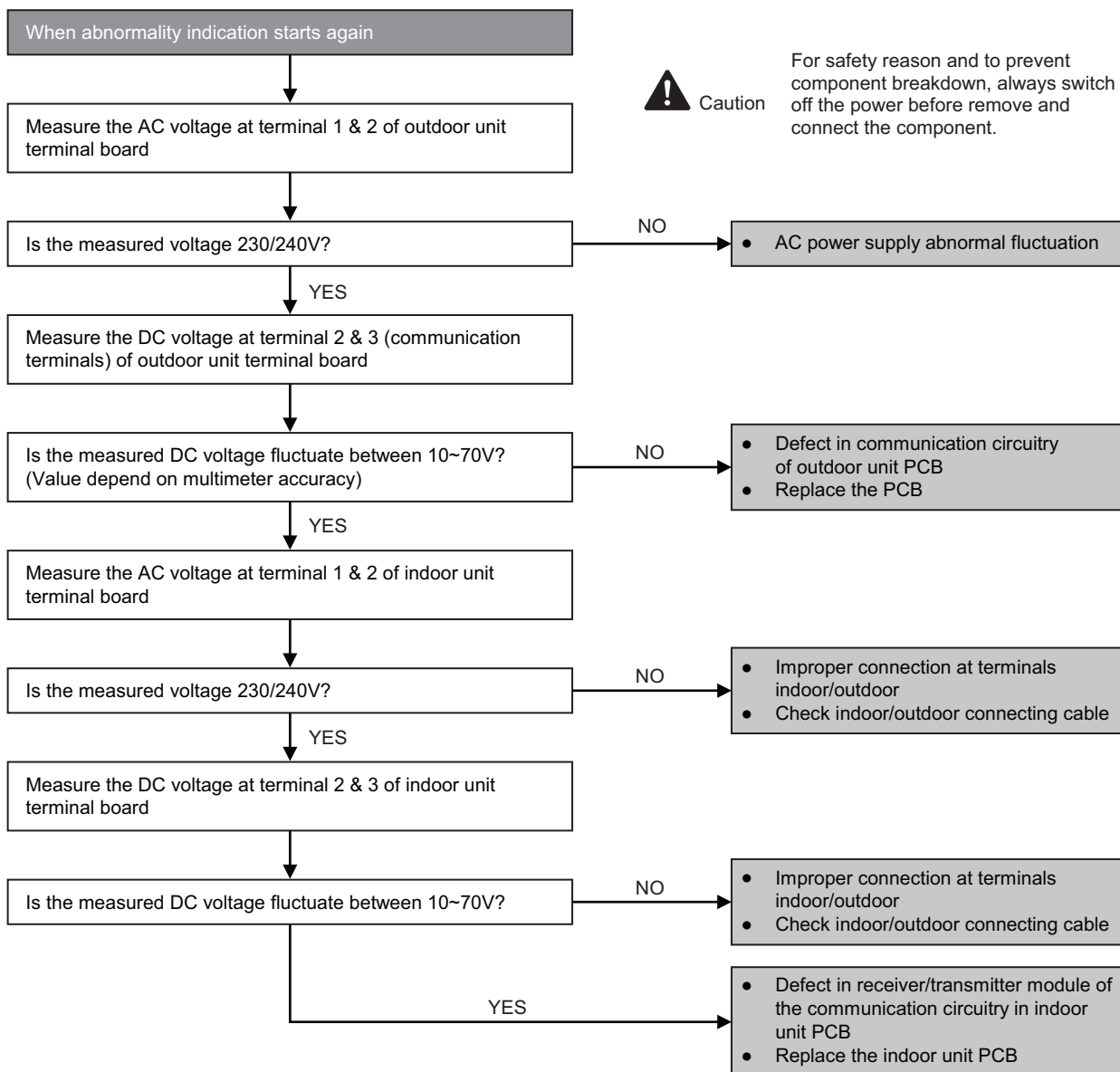

18.4.2 H12 (Indoor/Outdoor Capacity Rank Mismatched)

Malfunction Decision Conditions

- During startup, error code appears when different types of indoor and outdoor units are interconnected.

Malfunction Caused

- Wrong models interconnected.
- Wrong indoor unit or outdoor unit PCBs mounted.
- Indoor unit or outdoor unit PCBs defective.
- Indoor-outdoor unit signal transmission error due to wrong wiring.
- Indoor-outdoor unit signal transmission error due to breaking of wire 3 in the connection wires between the indoor and outdoor units.

Troubleshooting

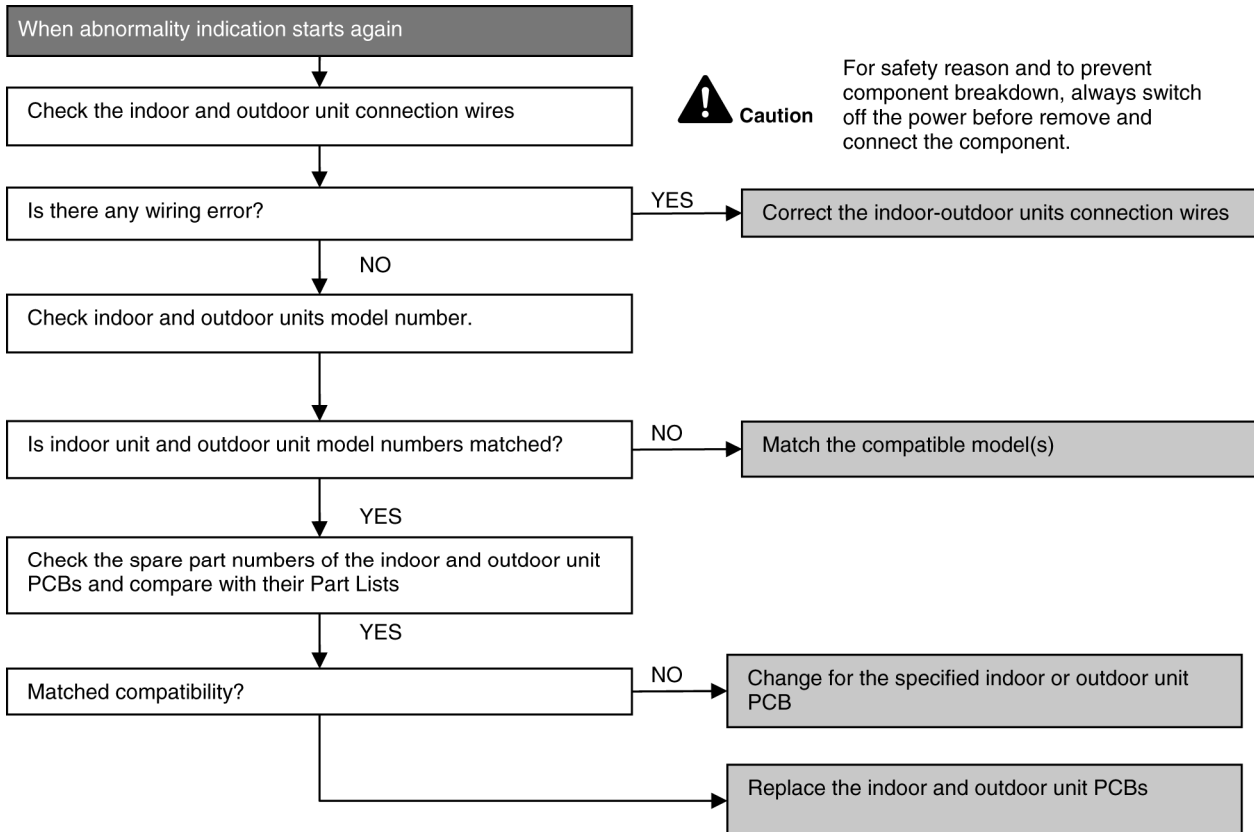

18.4.3 H14 (Indoor Intake Air Temperature Sensor Abnormality)

Malfunction Decision Conditions

- During startup and operation of cooling and heating, the temperatures detected by the indoor intake air temperature sensor are used to determine sensor errors.

Malfunction Caused

- Faulty connector connection.
- Faulty sensor.
- Faulty PCB.

Troubleshooting

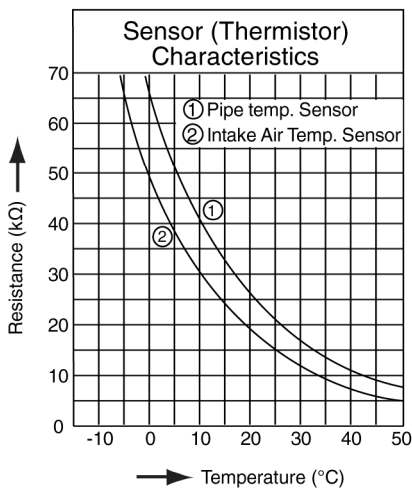
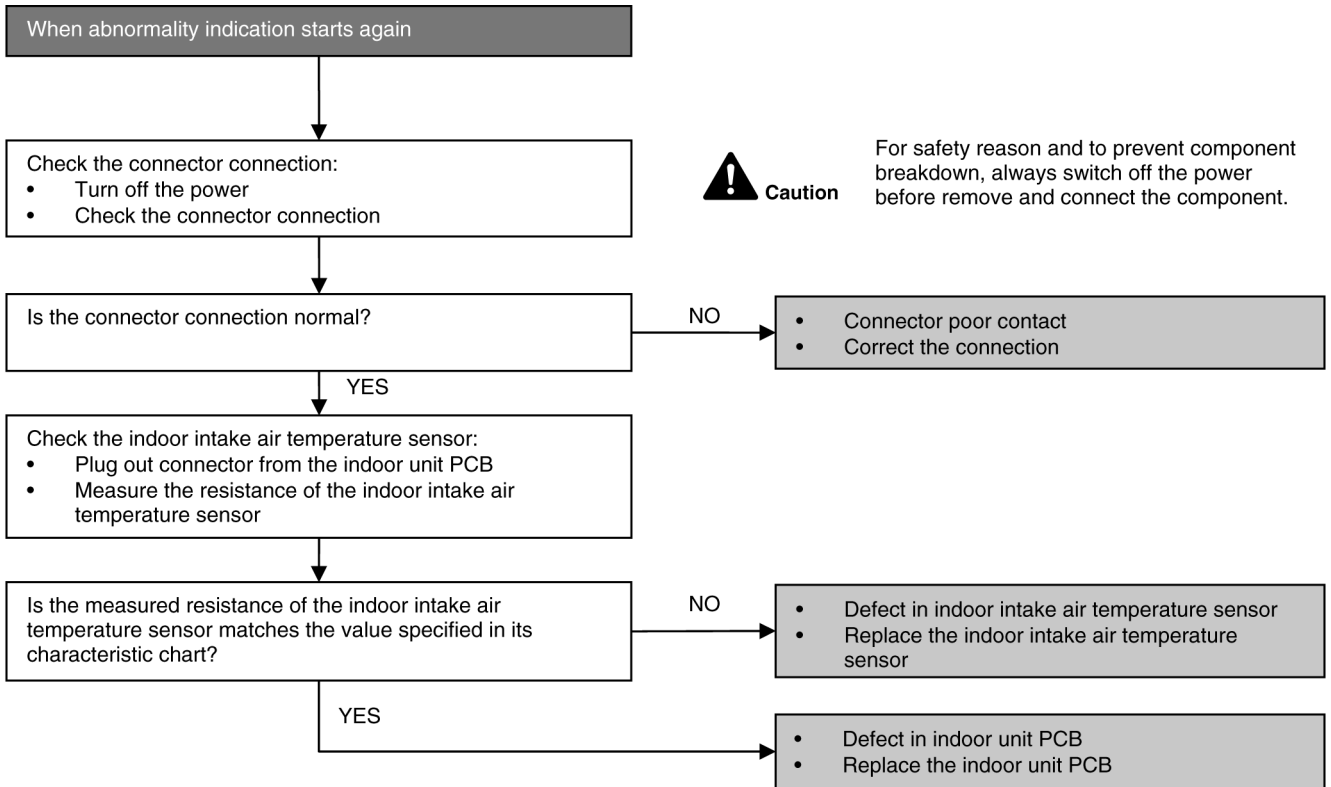

18.4.4 H15 (Compressor Temperature Sensor Abnormality)

Malfunction Decision Conditions

- During startup and operation of cooling and heating, the temperatures detected by the outdoor compressor temperature sensor are used to determine sensor errors.

Malfunction Caused

- Faulty connector connection.
- Faulty sensor.
- Faulty PCB.

Troubleshooting

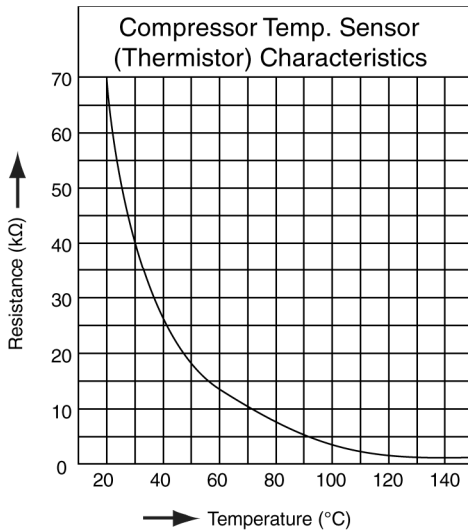
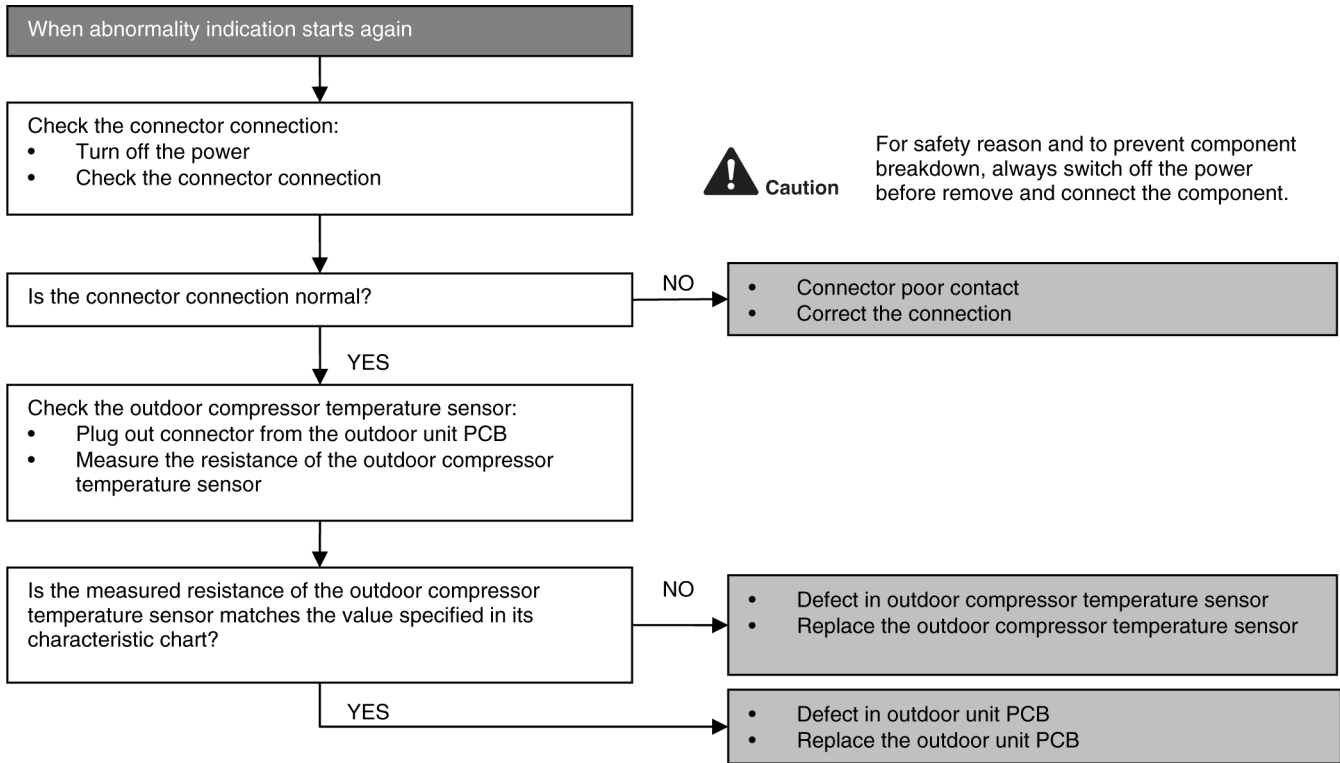

18.4.5 H16 (Outdoor Current Transformer)

Malfunction Decision Conditions

- An input current, detected by Current Transformer CT, is below threshold value when the compressor is operating at certain frequency value for 3 minutes.

Malfunction Caused

- Lack of gas
- Broken CT (current transformer)
- Broken Outdoor PCB

Troubleshooting

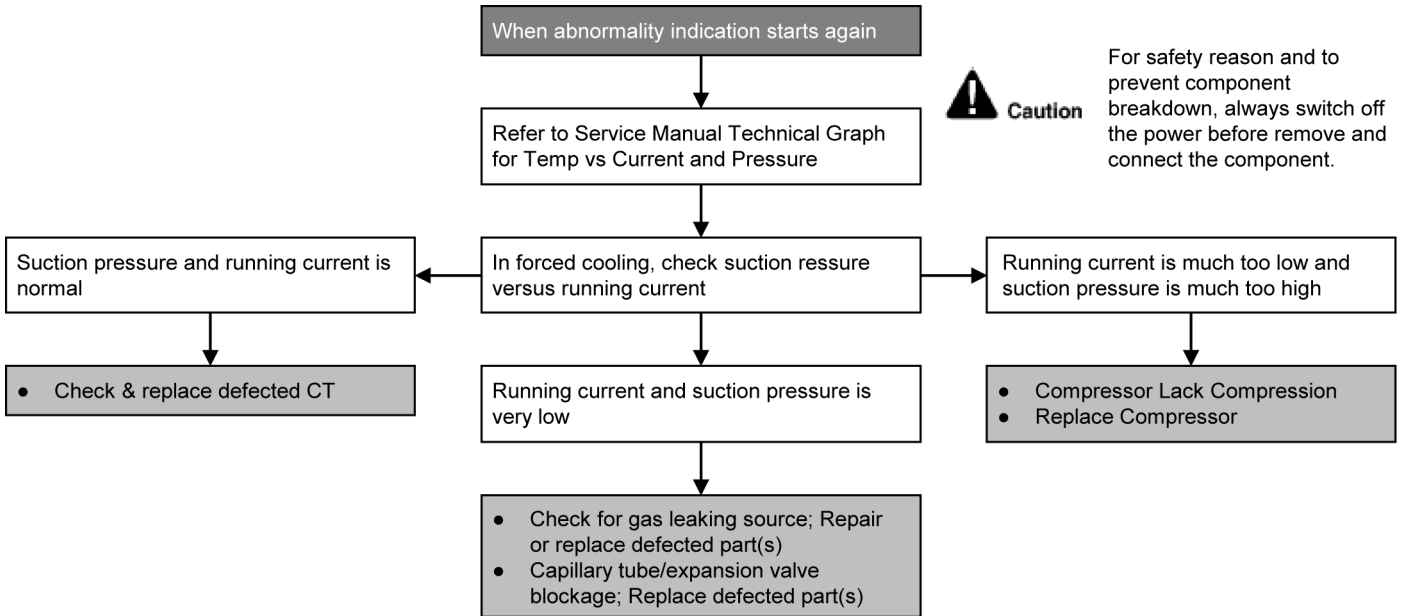

18.4.6 H19 (Indoor Fan Motor – DC Motor Mechanism Locked)

Malfunction Decision Conditions

- The rotation speed detected by the Hall IC during fan motor operation is used to determine abnormal fan motor (feedback of rotation > 2550 rpm or < 50 rpm)

Malfunction Caused

- Operation stops due to short circuit inside the fan motor winding.
- Operation stops due to breaking of wire inside the fan motor.
- Operation stops due to breaking of fan motor lead wires.
- Operation stops due to Hall IC malfunction.
- Operation error due to faulty indoor unit PCB.

Troubleshooting

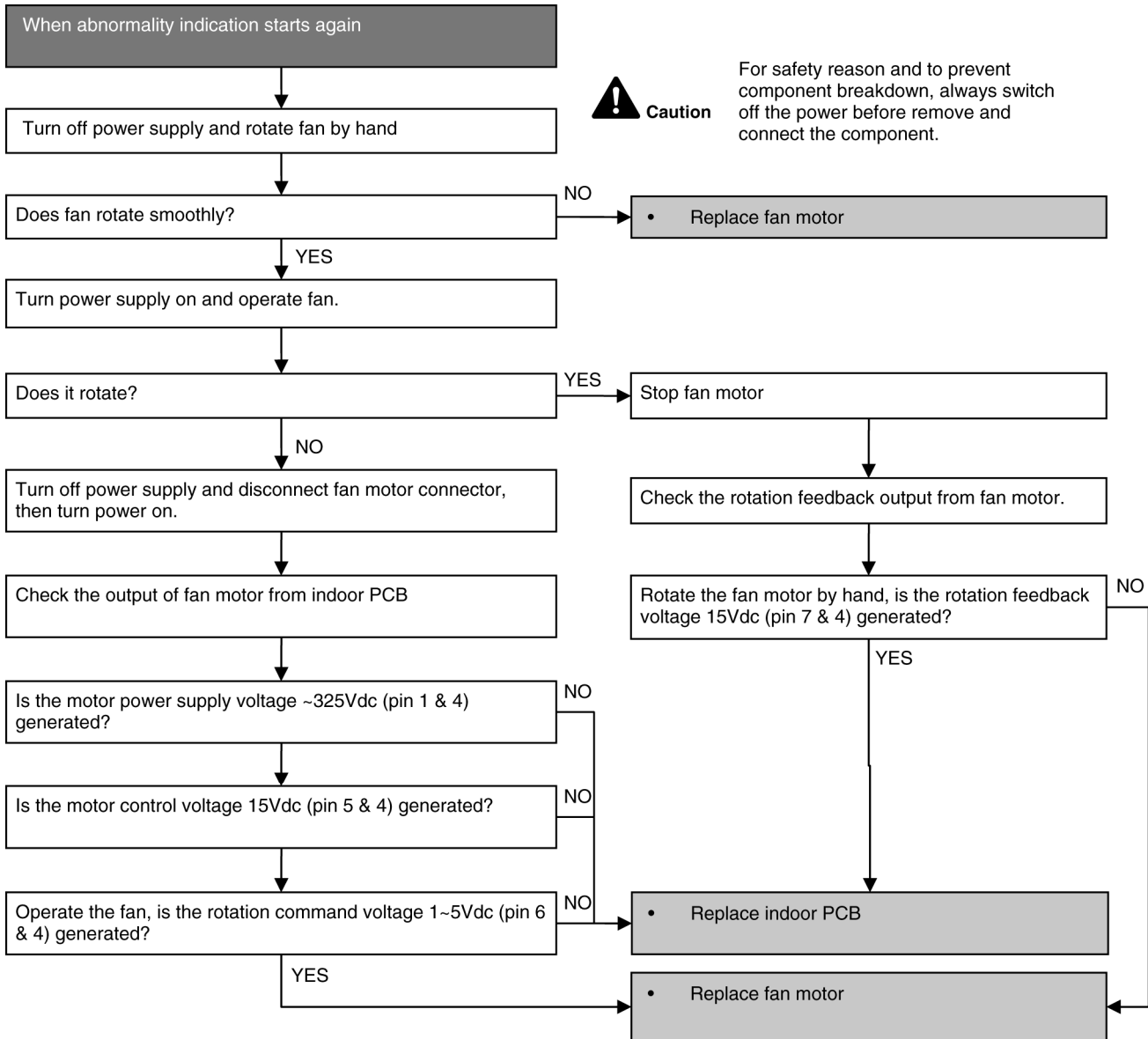

18.4.7 H23 (Indoor Pipe Temperature Sensor 1 Abnormality)

Malfunction Decision Conditions

- During startup and operation of cooling and heating, the temperatures detected by the indoor heat exchanger temperature sensor are used to determine sensor errors.

Malfunction Caused

- Faulty connector connection.
- Faulty sensor.
- Faulty PCB.

Troubleshooting

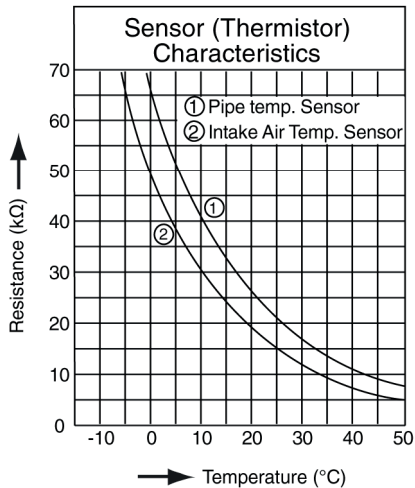
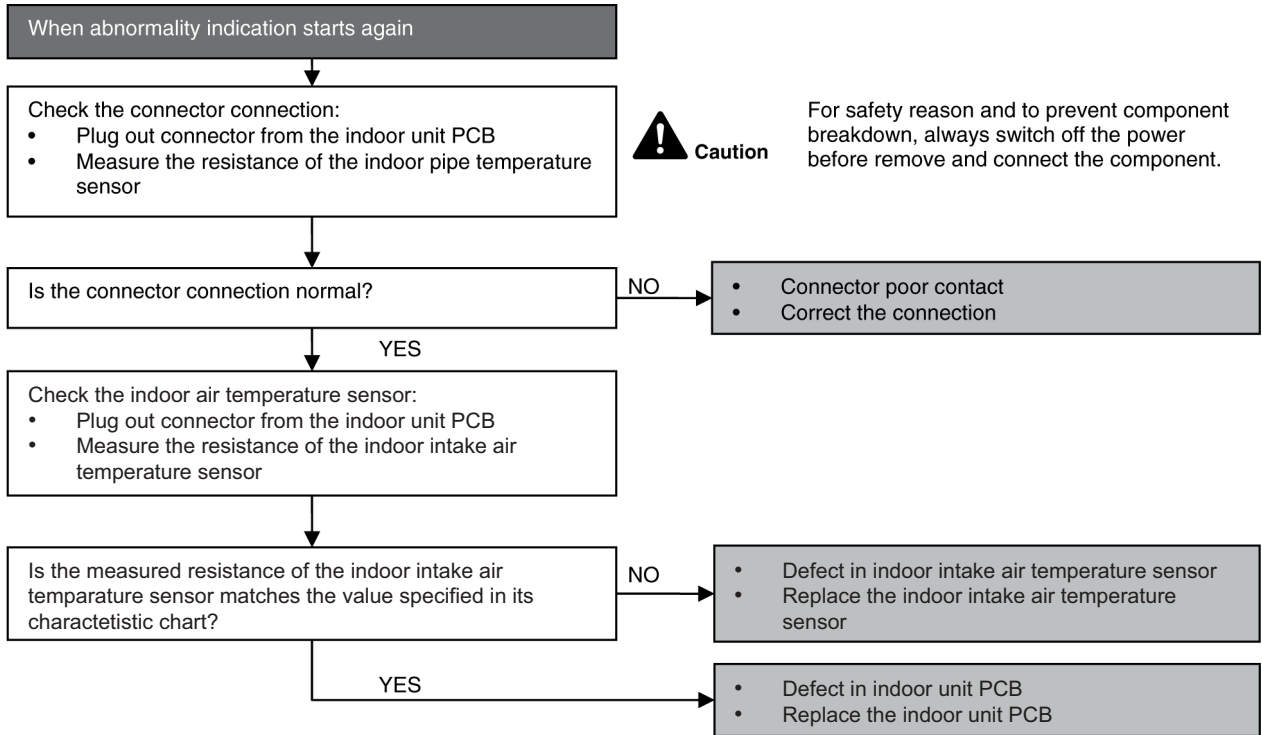

18.4.8 H24 (Indoor Pipe Temperature Sensor 2 Abnormality)

Malfunction Decision Conditions

- During startup and operation of cooling and heating, the temperatures detected by the indoor heat exchanger temperature sensor are used to determine sensor errors.

Malfunction Caused

- Faulty connector connection.
- Faulty sensor.
- Faulty PCB.

Troubleshooting

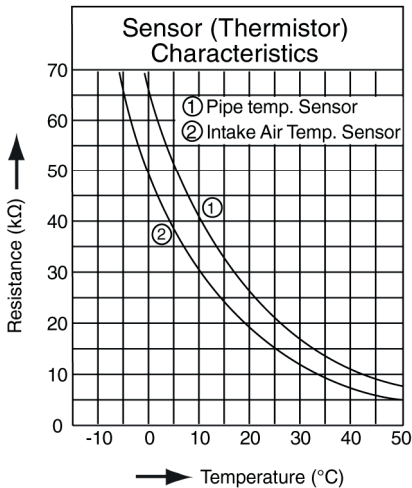
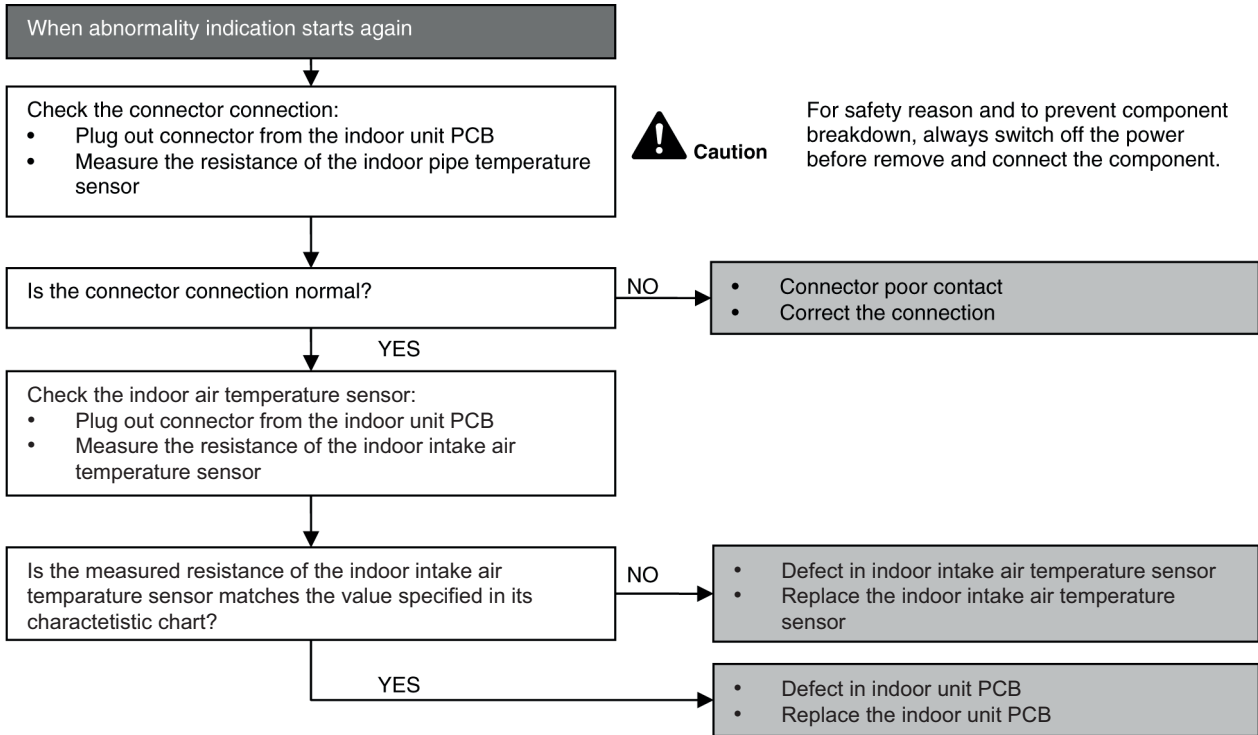

18.4.9 H27 (Outdoor Air Temperature Sensor Abnormality)

Malfunction Decision Conditions

- During startup and operation of cooling and heating, the temperatures detected by the outdoor air temperature sensor are used to determine sensor errors.

Malfunction Caused

- Faulty connector connection.
- Faulty sensor.
- Faulty PCB.

Troubleshooting

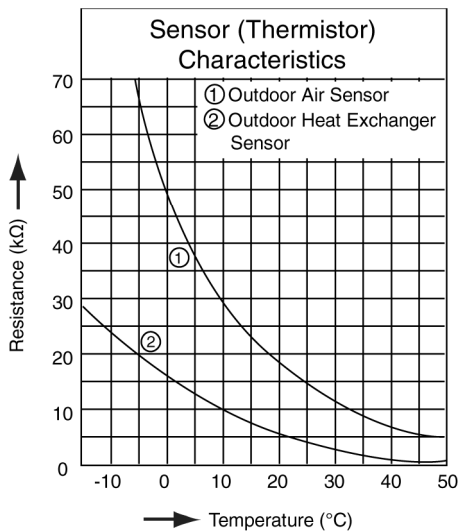
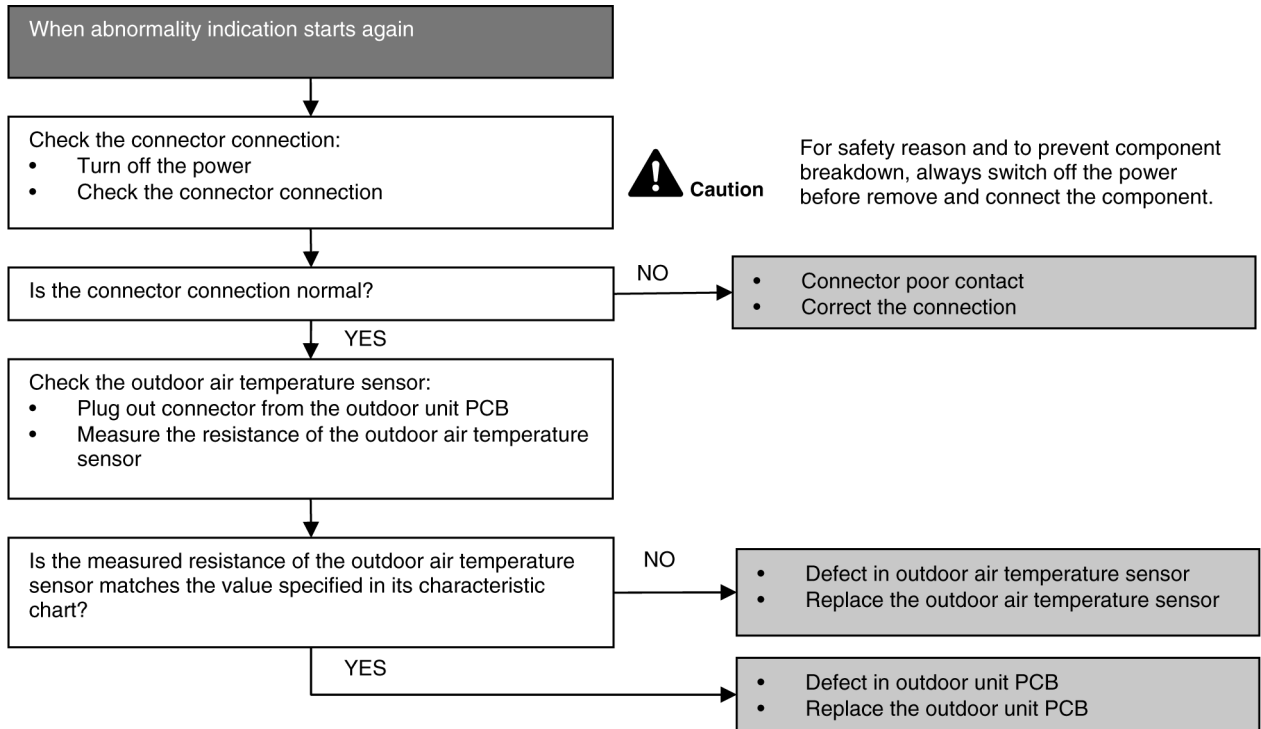

18.4.10 H28 (Outdoor Pipe Temperature Sensor Abnormality)

Malfunction Decision Conditions

- During startup and operation of cooling and heating, the temperatures detected by the outdoor pipe temperature sensor are used to determine sensor errors.

Malfunction Caused

- Faulty connector connection.
- Faulty sensor.
- Faulty PCB.

Troubleshooting

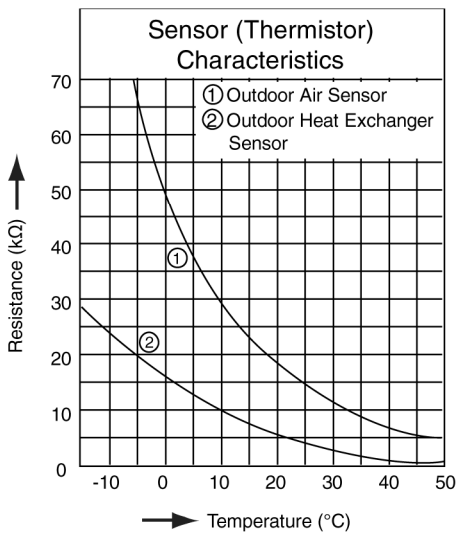
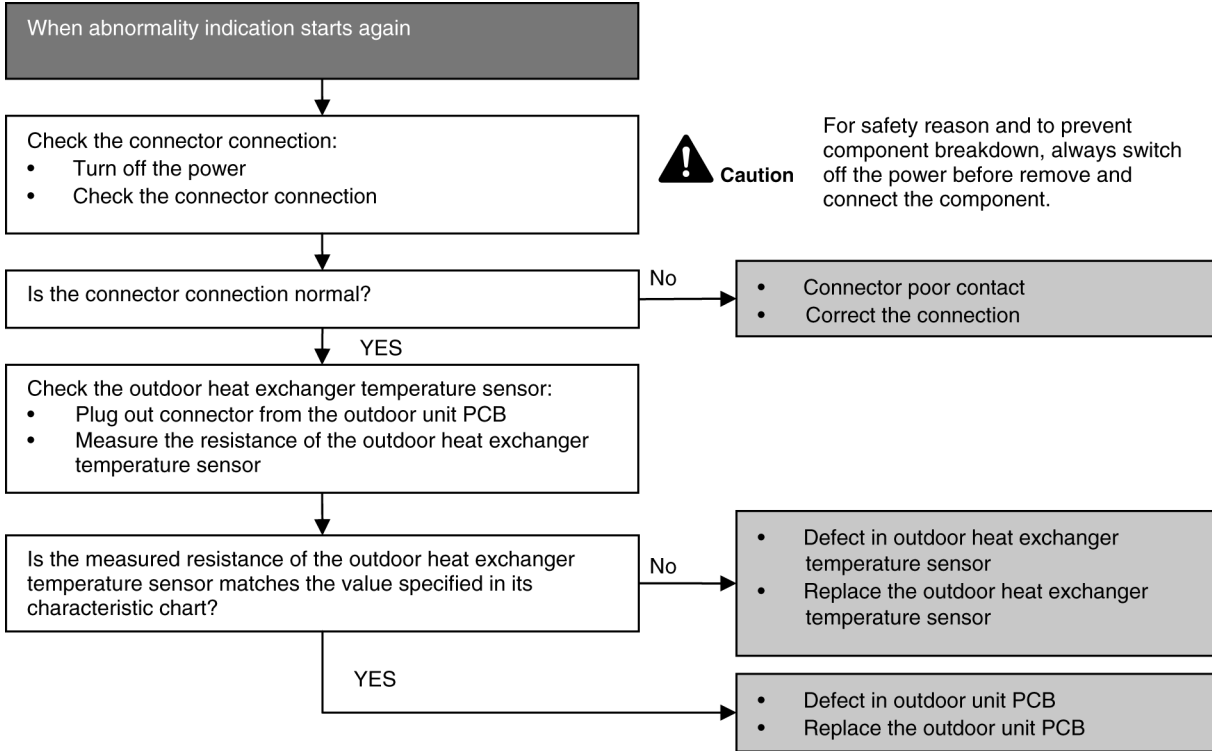

18.4.11 H30 (Compressor Discharge Temperature Sensor Abnormality)

Malfunction Decision Conditions

- During startup and operation of cooling and heating, the temperatures detected by the outdoor discharge pipe temperature sensor are used to determine sensor errors.

Malfunction Caused

- Faulty connector connection.
- Faulty sensor.
- Faulty PCB.

Troubleshooting

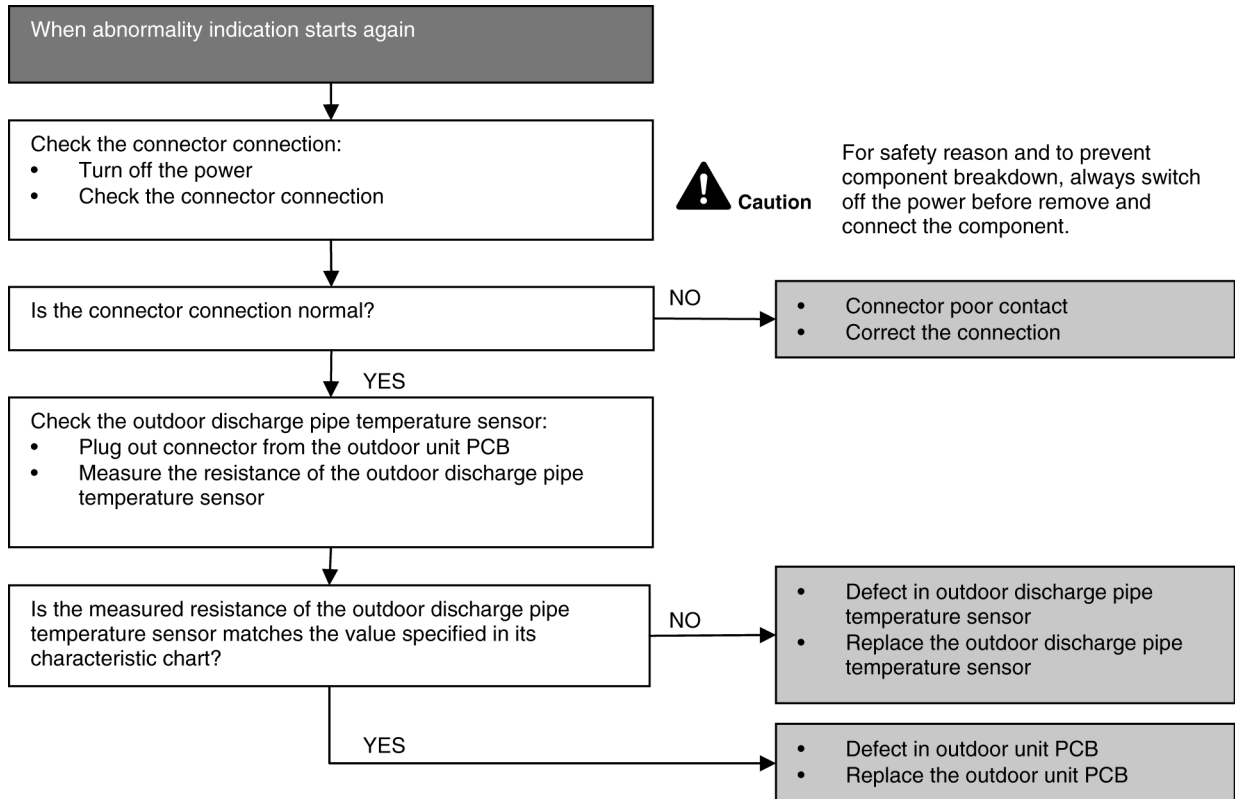

18.4.12 H32 (Outdoor Heat Exchanger Temperature Sensor 2 Abnormality)

Malfunction Decision Conditions

- During startup and operation of cooling and heating, the temperatures detected by the outdoor heat exchanger temperature sensor are used to determine sensor errors.

Malfunction Caused

- Faulty connector connection.
- Faulty sensor.
- Faulty PCB.

Troubleshooting

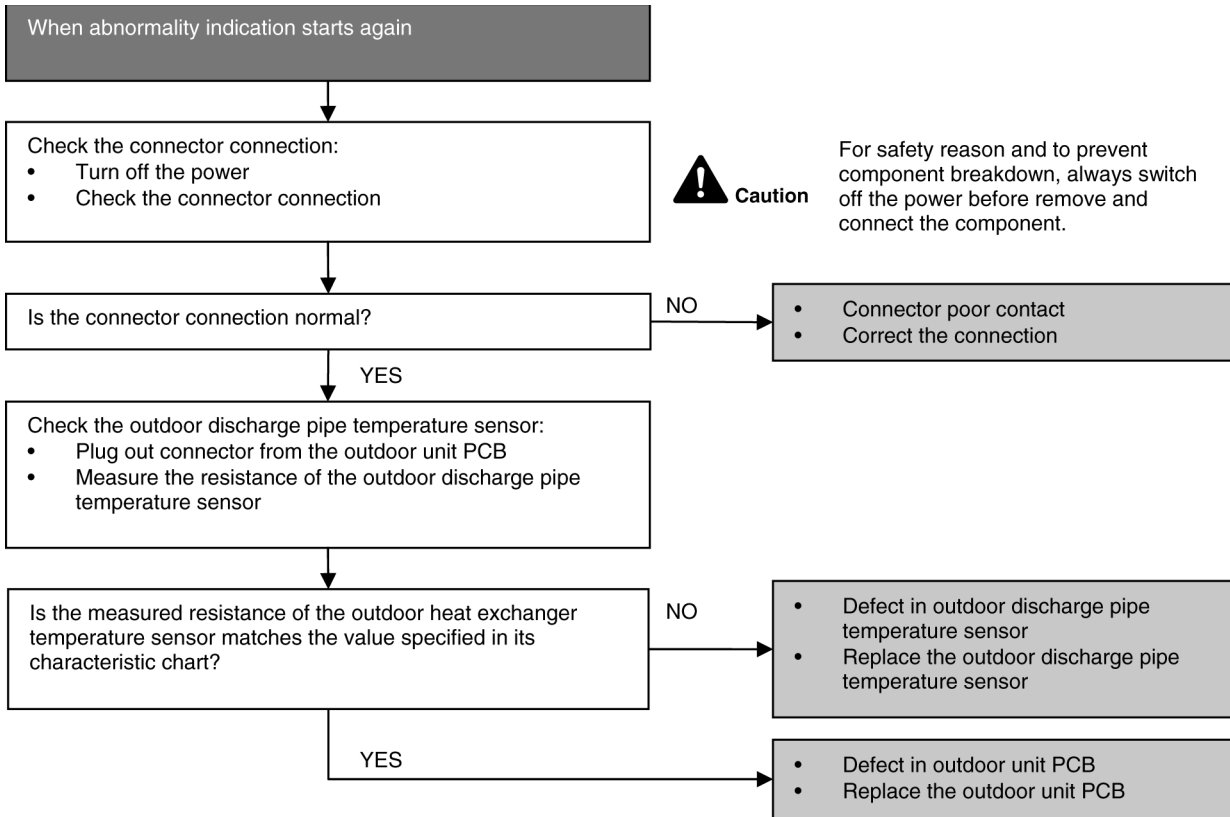

18.4.13 H33 (Unspecified Voltage between Indoor and Outdoor)

Malfunction Decision Conditions

- The supply power is detected for its requirement by the indoor/outdoor transmission.

Malfunction Caused

- Wrong models interconnected.
- Wrong indoor unit and outdoor unit PCBs used.
- Indoor unit or outdoor unit PCB defective.

Troubleshooting

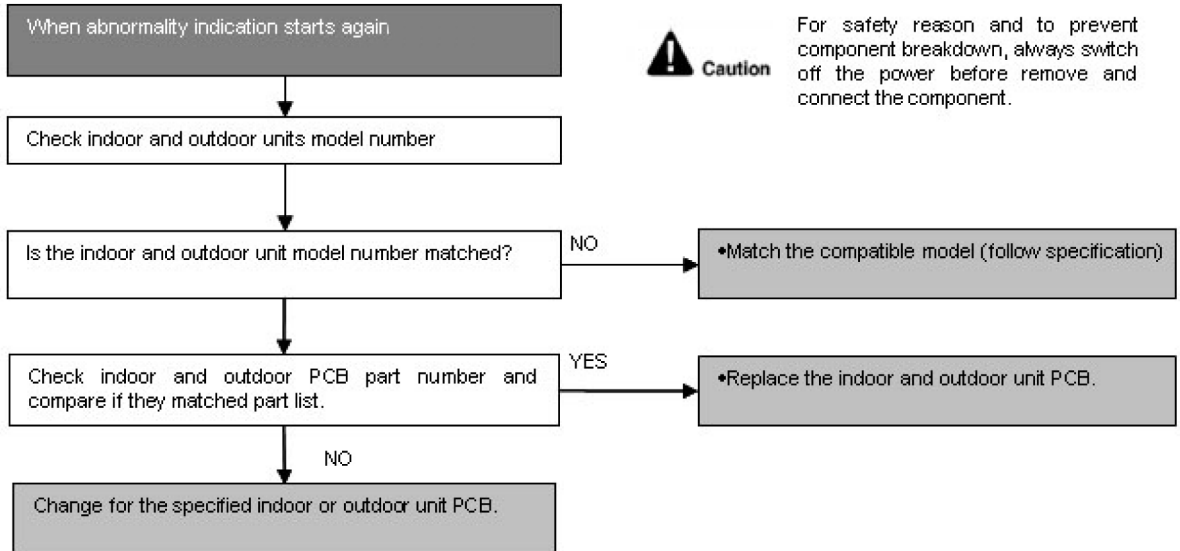

18.4.14 H34 (Outdoor Heat Sink Temperature Sensor Abnormality)

Malfunction Decision Conditions

- During startup and operation of cooling and heating, the temperatures detected by the outdoor heat sink temperature sensor are used to determine sensor errors.

Malfunction Caused

- Faulty connector connection.
- Faulty sensor.
- Faulty PCB.

Troubleshooting

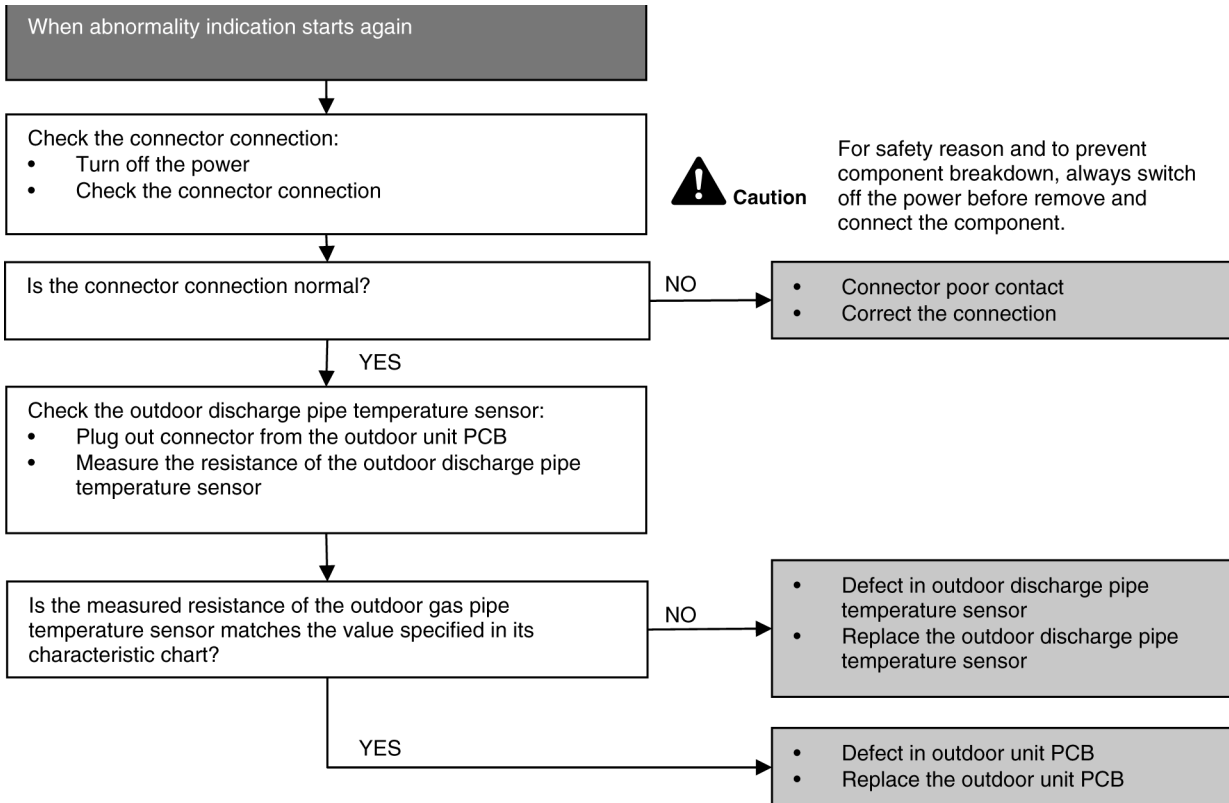

18.4.15 H36 (Outdoor Gas Pipe Sensor Abnormality)

Malfunction Decision Conditions

- During startup and operation of cooling and heating, the temperatures detected by the outdoor gas pipe temperature sensor are used to determine sensor errors.

Malfunction Caused

- Faulty connector connection.
- Faulty sensor.
- Faulty PCB.

Troubleshooting

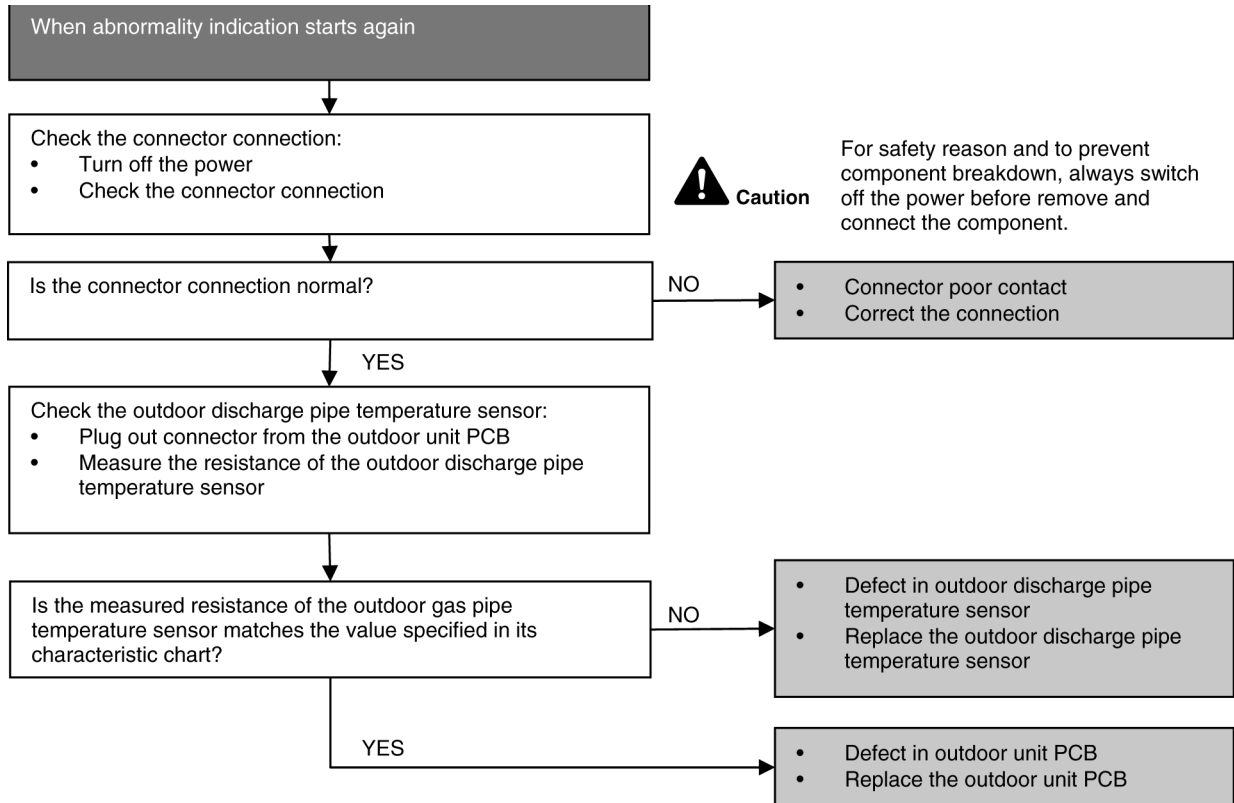

18.4.16 H37 (Outdoor Liquid Pipe Temperature Sensor Abnormality)

Malfunction Decision Conditions

- During startup and operation of cooling and heating, the temperatures detected by the outdoor liquid pipe temperature sensor are used to determine sensor errors.

Malfunction Caused

- Faulty connector connection.
- Faulty sensor.
- Faulty PCB.

Troubleshooting

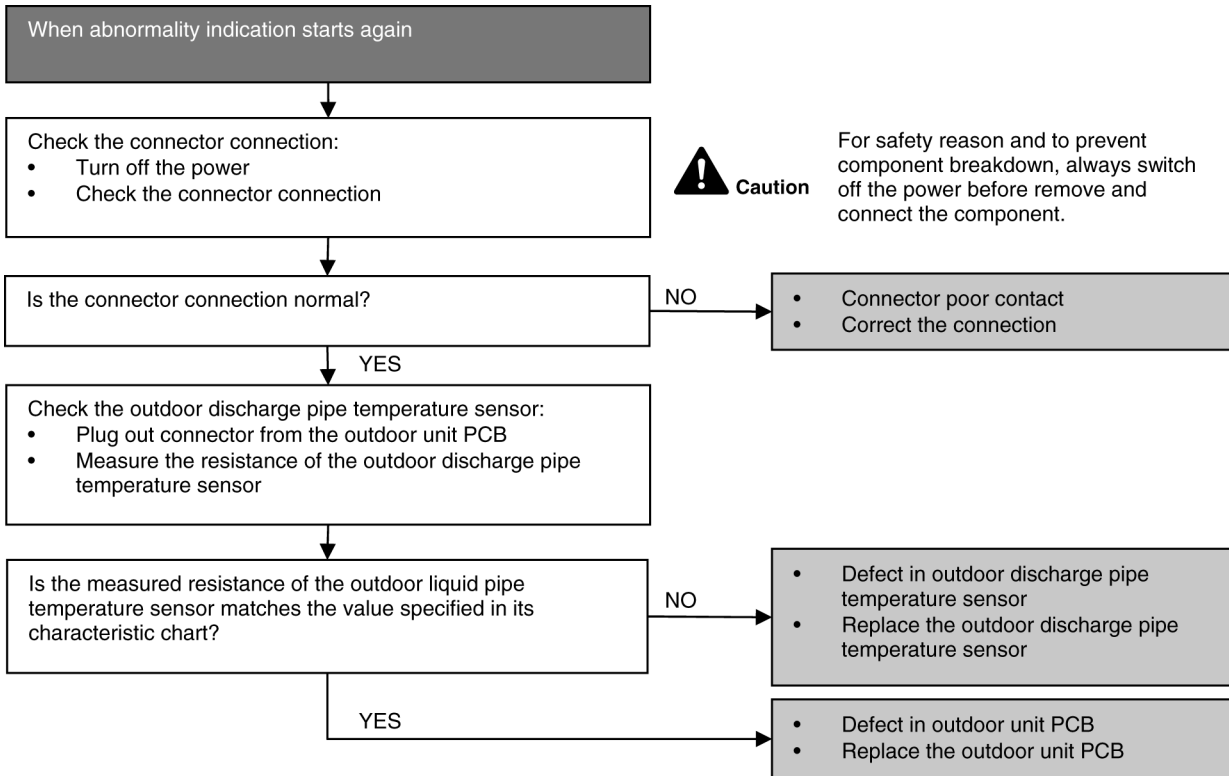

18.4.17 H97 (Outdoor Fan Motor – DC Motor Mechanism Locked)

Malfunction Decision Conditions

- The rotation speed detected by the Hall IC during fan motor operation is used to determine abnormal fan motor.

Malfunction Caused

- Operation stops due to short circuit inside the fan motor winding.
- Operation stops due to breaking of wire inside the fan motor.
- Operation stops due to breaking of fan motor lead wires.
- Operation stops due to Hall IC malfunction.
- Operation error due to faulty outdoor unit PCB.

Troubleshooting

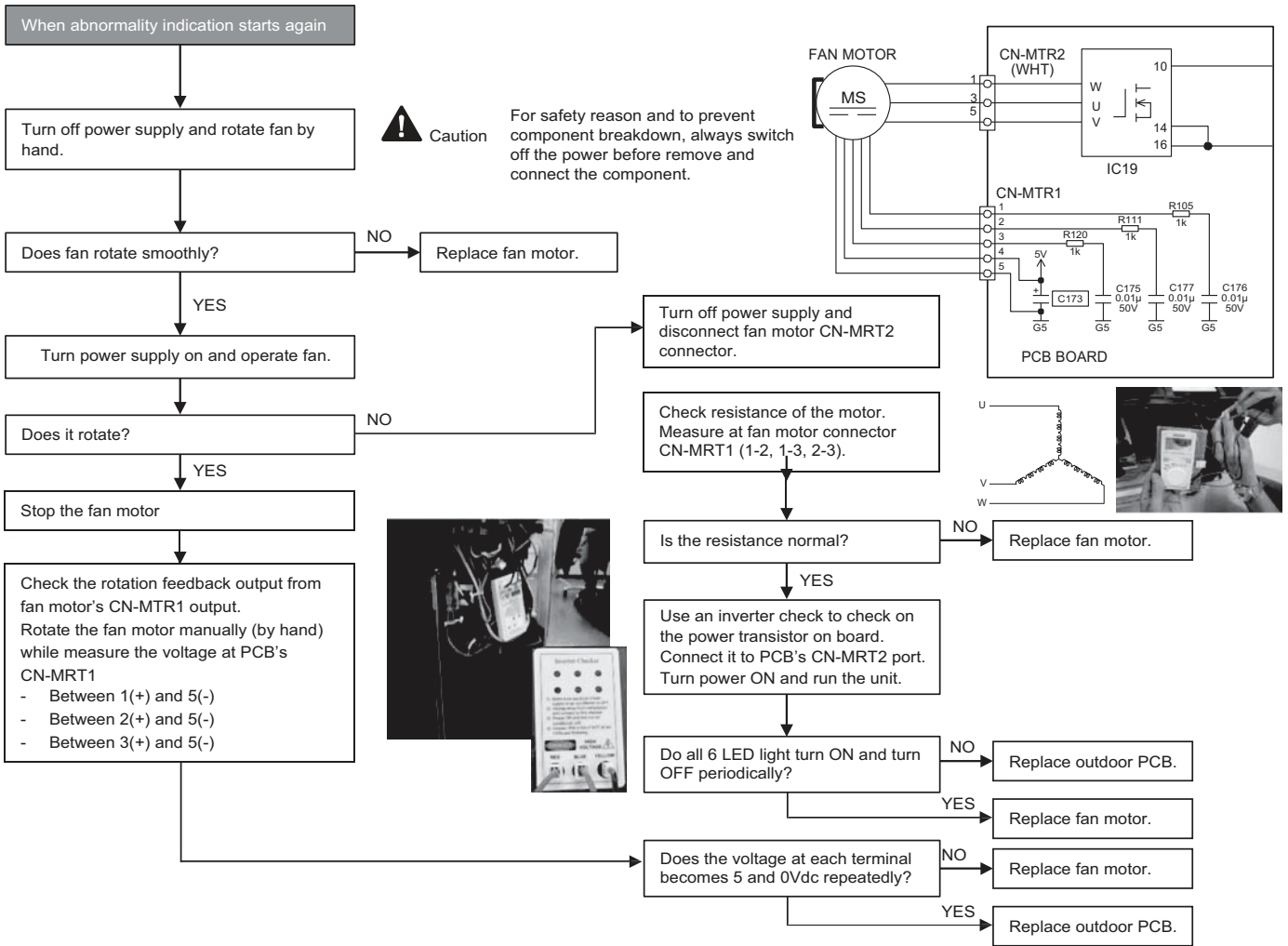

18.4.18 H98 (Error Code Stored in Memory and no alarm is triggered / no TIMER LED flashing)

Malfunction Decision Conditions

- Indoor high pressure is detected when indoor heat exchanger is detecting very high temperature when the unit is operating in heating operation.
- Phenomena: unit is stopping and re-starting very often in heating mode

Malfunction Caused

- Indoor heat exchanger thermistor
- Clogged air filter or heat exchanger
- Over-bent pipe (liquid side)

Troubleshooting

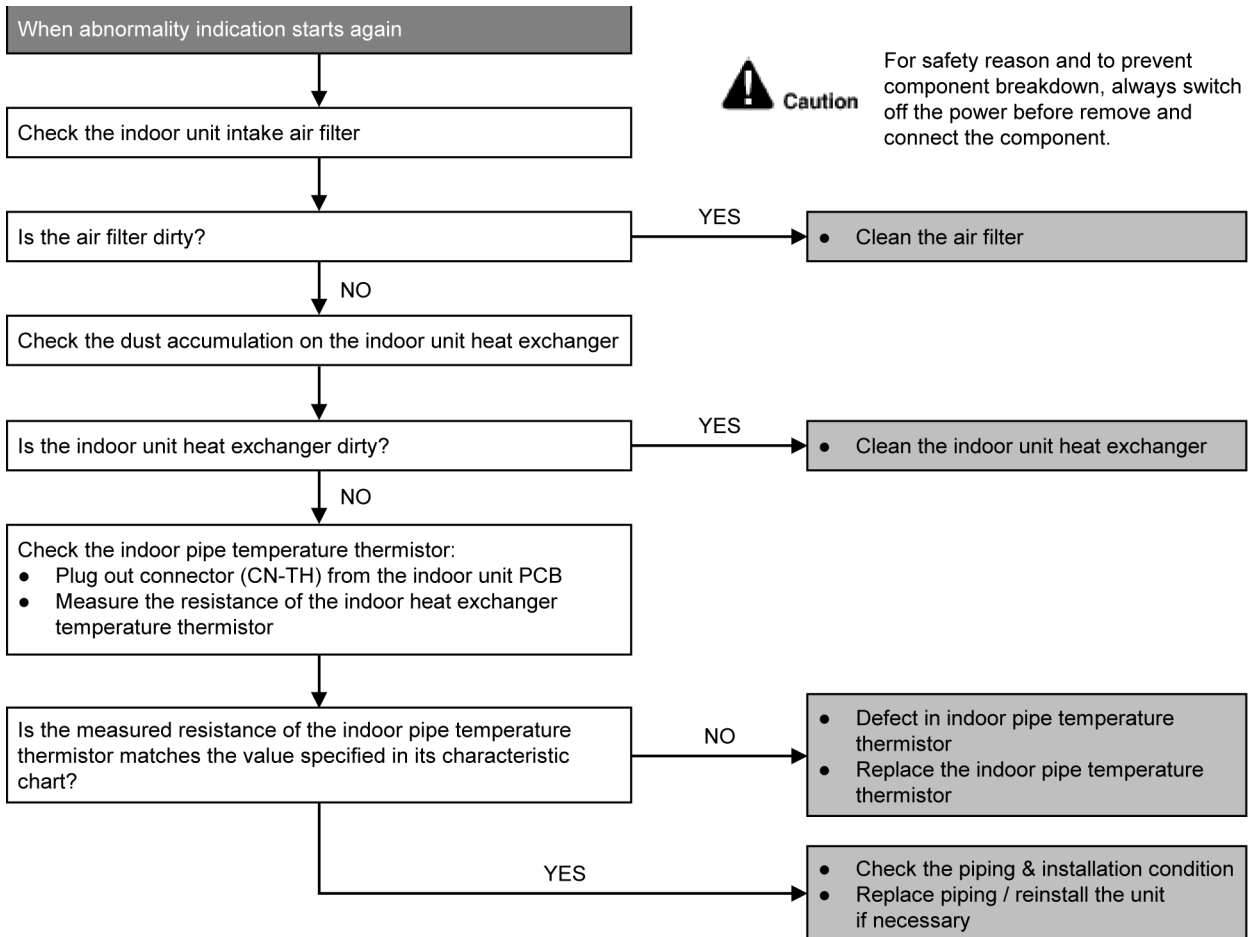

18.4.19 H99 (Indoor Freeze Prevention Protection: Cooling or Soft Dry)

Error Code will not display (no Timer LED blinking) but store in EEPROM

Malfunction Decision Conditions

- Freeze prevention control takes place (when indoor pipe temperature is lower than 2°C)

Malfunction Caused

- Air short circuit at indoor unit
- Clogged indoor unit air filter
- Dust accumulation on the indoor unit heat exchanger
- 2/3 way valve closed
- Faulty indoor unit fan motor
- Refrigerant shortage (refrigerant leakage)
- Clogged expansion valve or strainer
- Faulty indoor pipe temperature sensor
- Faulty indoor unit PCB

Troubleshooting

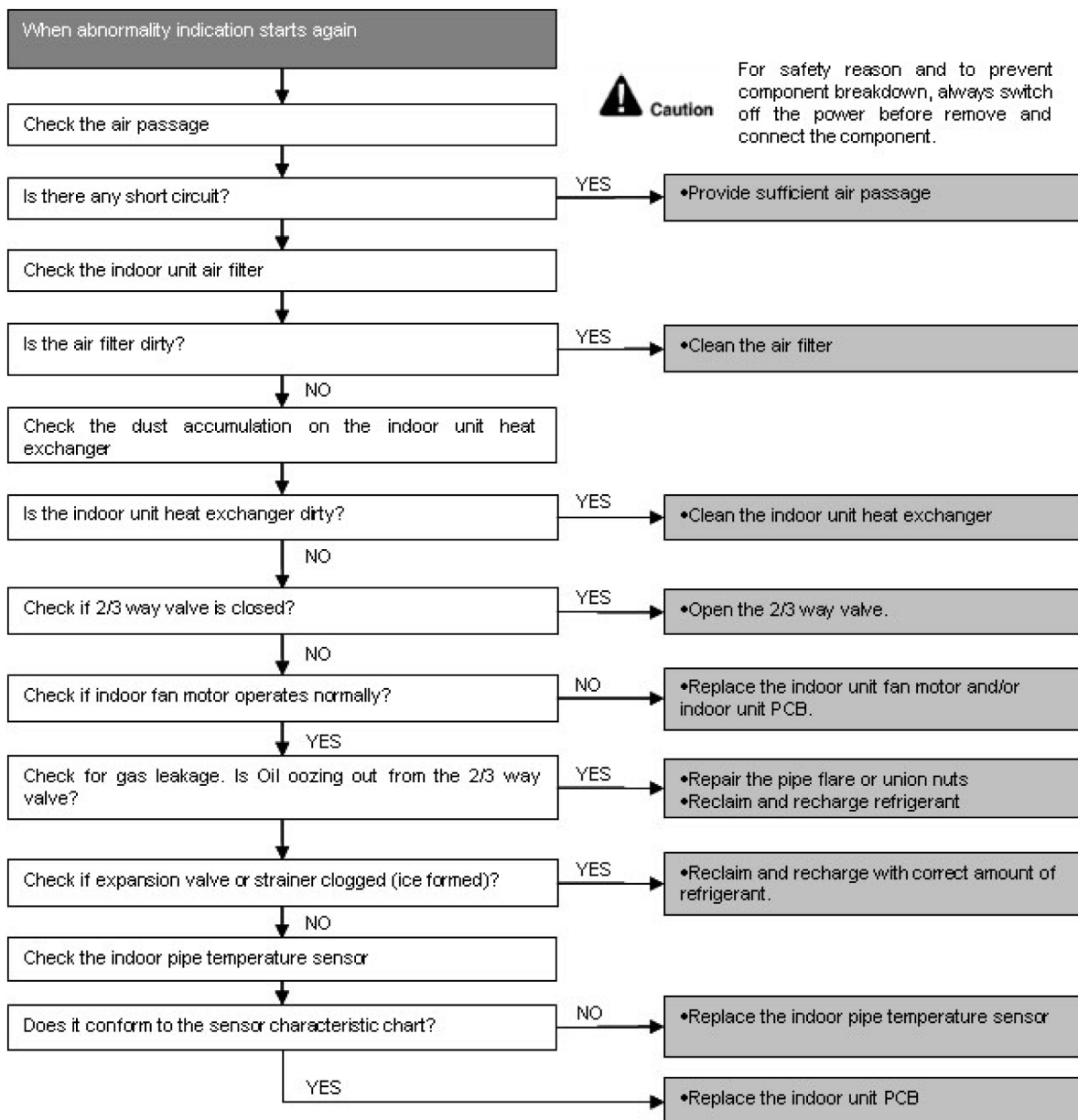

18.4.20 F11 (4-way Valve Switching Failure)

Malfunction Decision Conditions

- When indoor heat exchanger is cold during heating (except deice) or when indoor heat exchanger is hot during cooling and compressor operating, the 4-way valve is detected as malfunction.

Malfunction Caused

- Indoor heat exchanger (pipe) thermistor
- 4-way valve malfunction

Troubleshooting

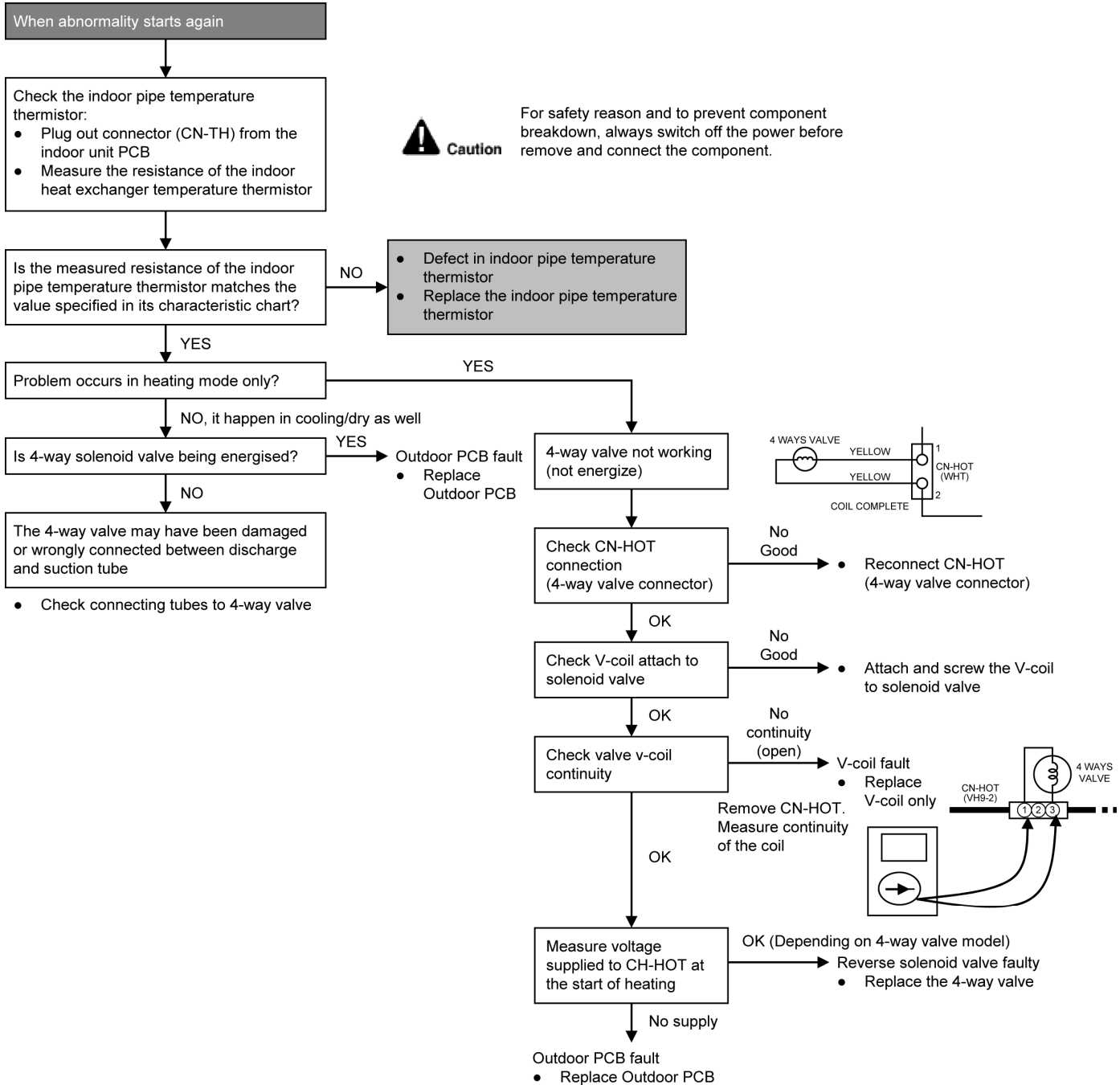

* Check gas side pipe – for hot gas flow in cooling mode

18.4.21 F17 (Indoor Standby Units Freezing Abnormality)

Malfunction Decision Conditions

- When the different between indoor intake air temperature and indoor pipe temperature is above 10°C or indoor pipe temperature is below -1.0°C.

Remark:

When the indoor standby unit is freezing, the outdoor unit transfers F17 error code to the corresponding indoor unit and H39 to other indoor unit(s).

Malfunction Caused

- Wrong wiring connection
- Faulty sensor
- Faulty expansion valve

Troubleshooting

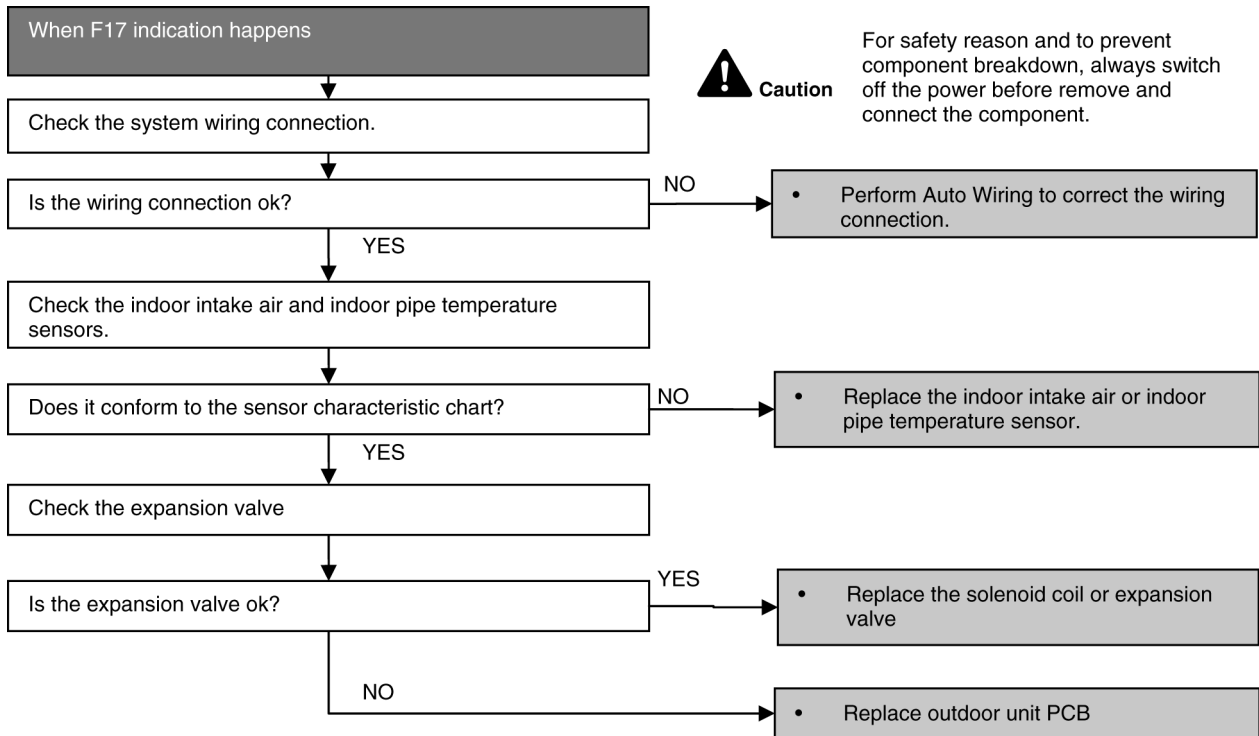

18.4.22 F90 (Power Factor Correction Protection)

Malfunction Decision Conditions

- To maintain DC voltage level supply to power transistor.
- To detect high DC voltage level after rectification.

Malfunction Caused

- During startup and operation of cooling and heating, when Power Factor Correction (PFC) protection circuitry at the outdoor unit main PCB senses abnormal DC voltage level for power transistors.
- When DC voltage detected is LOW, transistor switching will turn ON by controller to push-up the DC level.
- When DC voltage detected is HIGH (391Vdc – 425Vdc), active LOW signal will send by the controller to turn OFF relay RY-C.

Troubleshooting

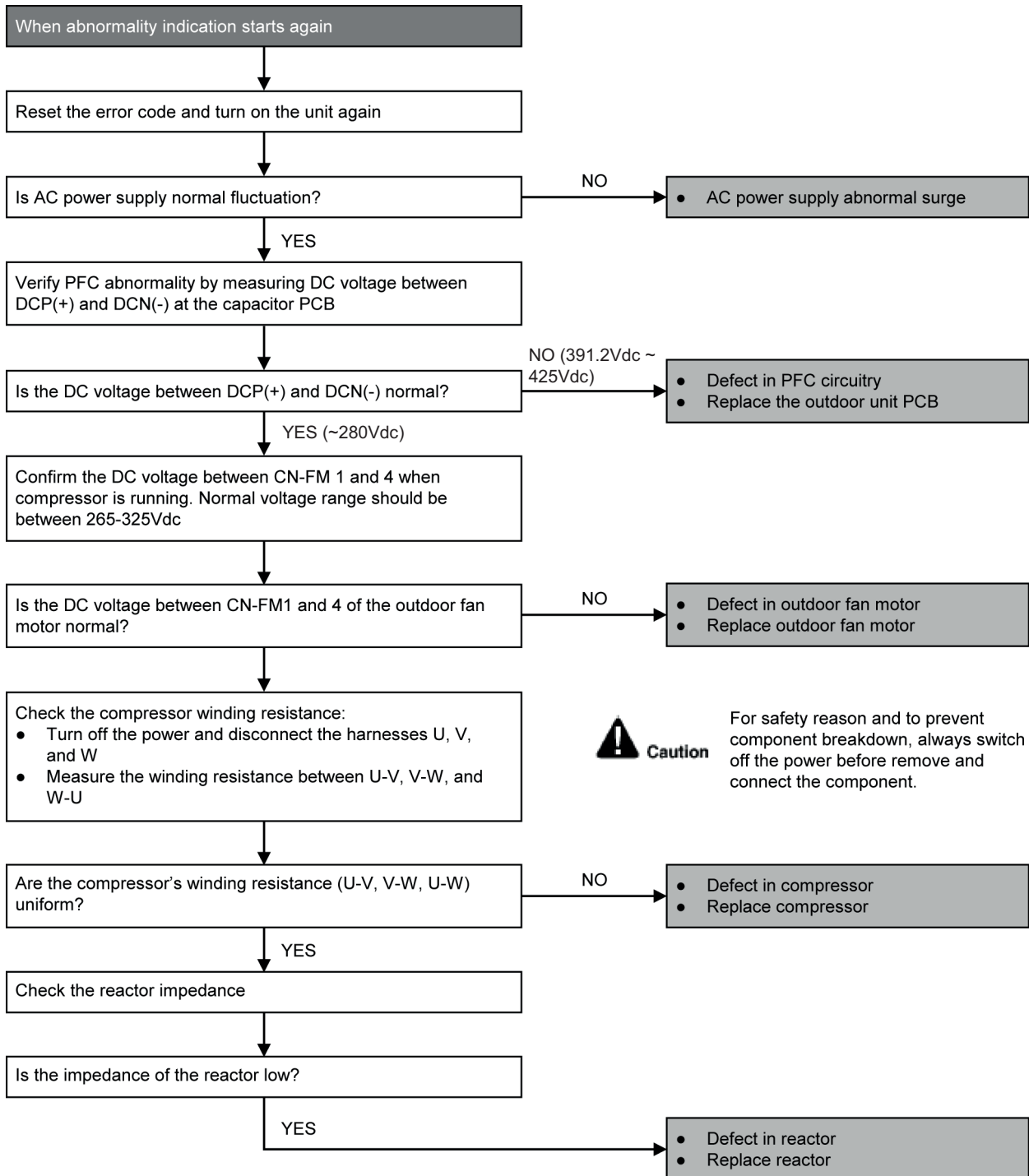

18.4.23 F91 (Refrigeration Cycle Abnormality)

Malfunction Decision Conditions

- The input current is low while the compressor is running at higher than the setting frequency.

Malfunction Caused

- Lack of gas.
- 3-way valve close.

Troubleshooting

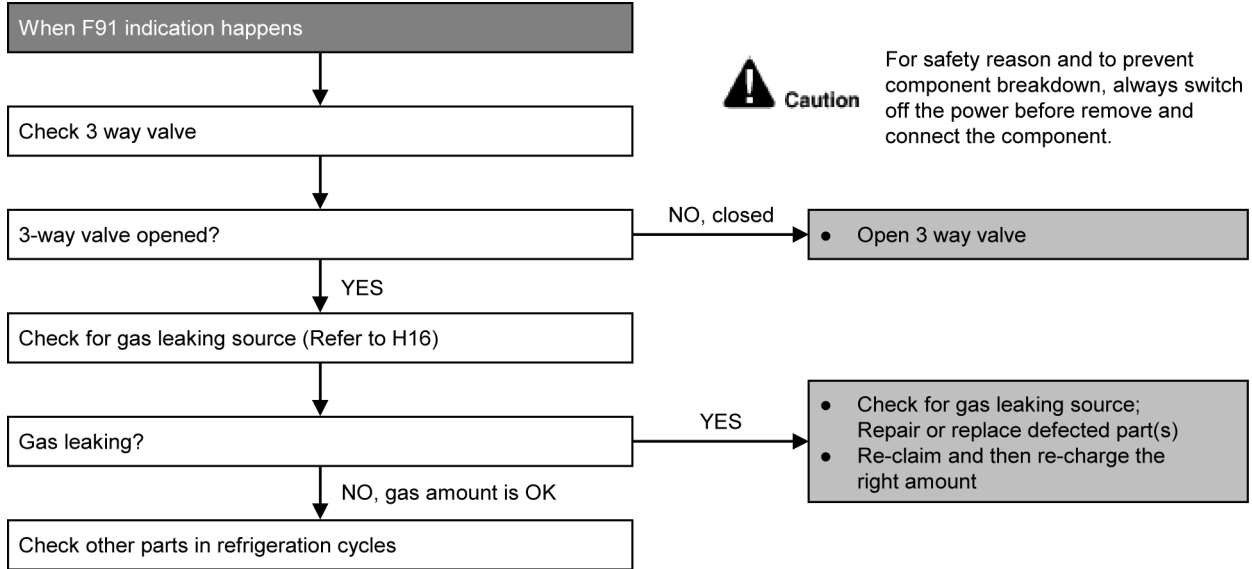

18.4.24 F93 (Compressor Rotation Failure)

Malfunction Decision Conditions

- A compressor rotation failure is detected by checking the compressor running condition through the position detection circuit.

Malfunction Caused

- Compressor terminal disconnect
- Faulty Outdoor PCB
- Faulty compressor

Troubleshooting

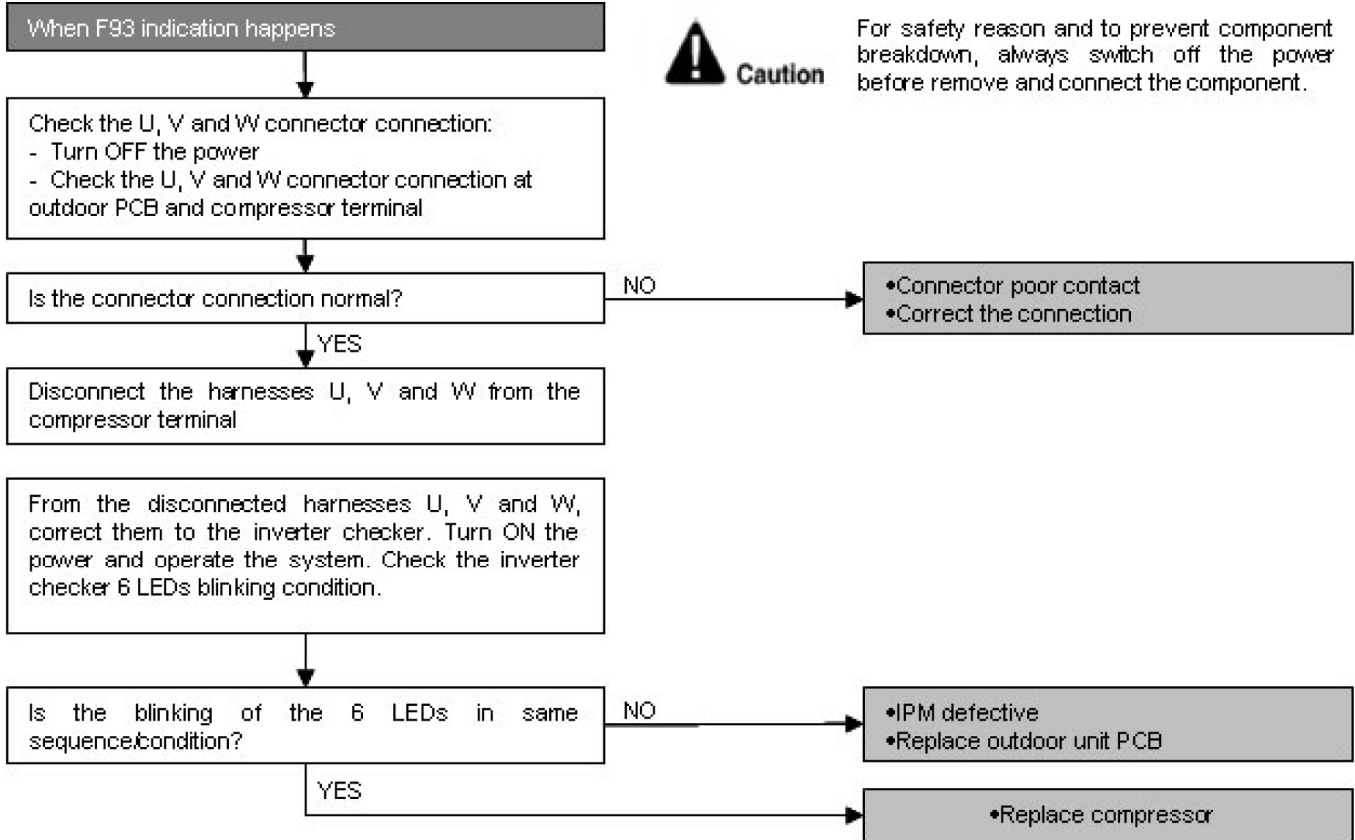

18.4.25 F95 (Outdoor High Pressure Protection: Cooling or Soft Dry)

Malfunction Decision Conditions

- During operation of cooling or soft dry, when outdoor unit heat exchanger high temperature data is detected by the outdoor unit heat exchanger thermistor.

Malfunction Caused

- Outdoor heat exchanger temperature rise due to short-circuit of hot discharge air flow.
- Outdoor heat exchanger temperature rise due to defective of outdoor fan motor.
- Outdoor heat exchange temperature rise due to defective outdoor heat exchanger thermistor.
- Outdoor heat exchanger temperature rise due to defective of outdoor unit PCB.

Troubleshooting

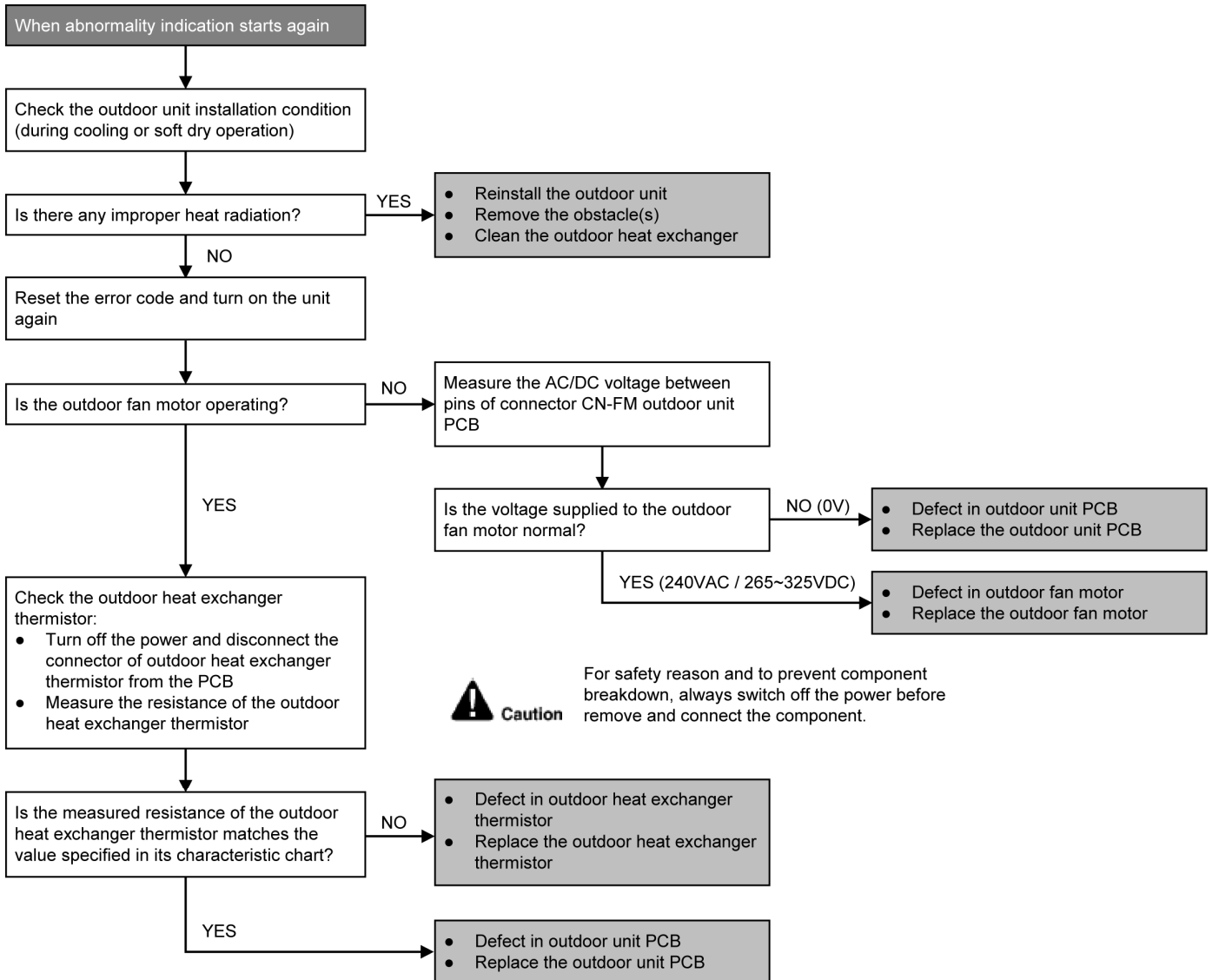

18.4.26 F96 (IPM Overheating)

Malfunction Decision Conditions

- During operating of cooling and heating, when IPM temperature data (100°C) is detected by the IPM temperature sensor.

Multi Models only

- Compressor Overheating: During operation of cooling and heating, when the compressor OL is activated.
- Heat Sink Overheating: During operation of cooling and heating, when heat sink temperature data (90°C) is detected by the heat sink temperature sensor.

Malfunction Caused

- IPM overheats due to short circuit of hot discharge air flow.
- IPM overheats due to defective of outdoor fan motor.
- IPM overheats due to defective of internal circuitry of IPM.
- IPM overheats due to defective IPM temperature sensor.

Multi Models Only

- Compressor OL connector poor contact.
- Compressor OL faulty.

Troubleshooting

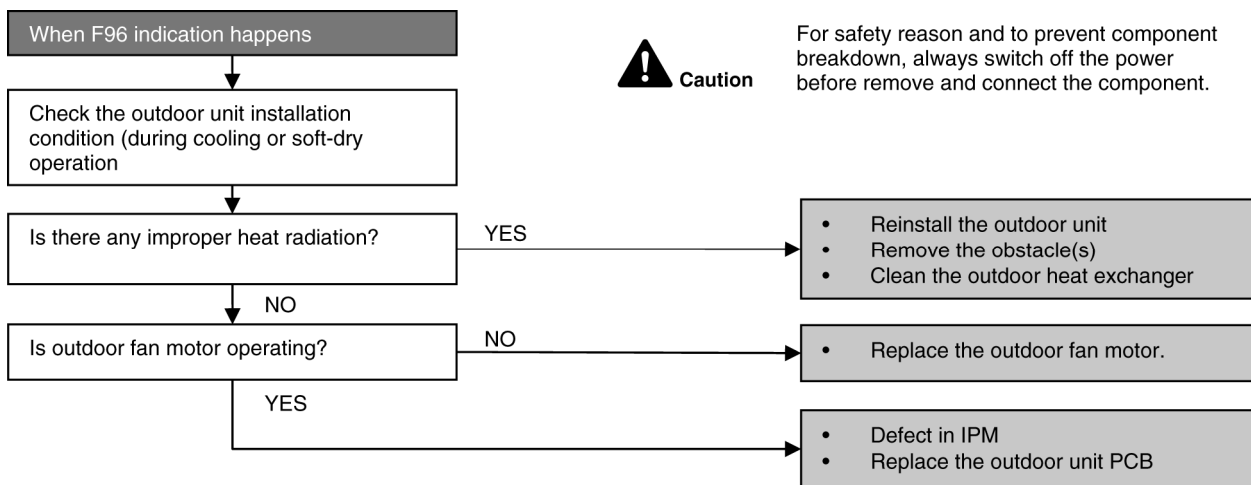

18.4.27 F97 (Compressor Overheating)

Malfunction Decision Conditions

- During operation of cooling and heating, when compressor tank temperature data (112°C) is detected by the compressor tank temperature sensor.

Malfunction Caused

- Faulty compressor tank temperature sensor
- 2/3 way valve closed
- Refrigerant shortage (refrigerant leakage)
- Faulty outdoor unit PCB
- Faulty compressor

Troubleshooting

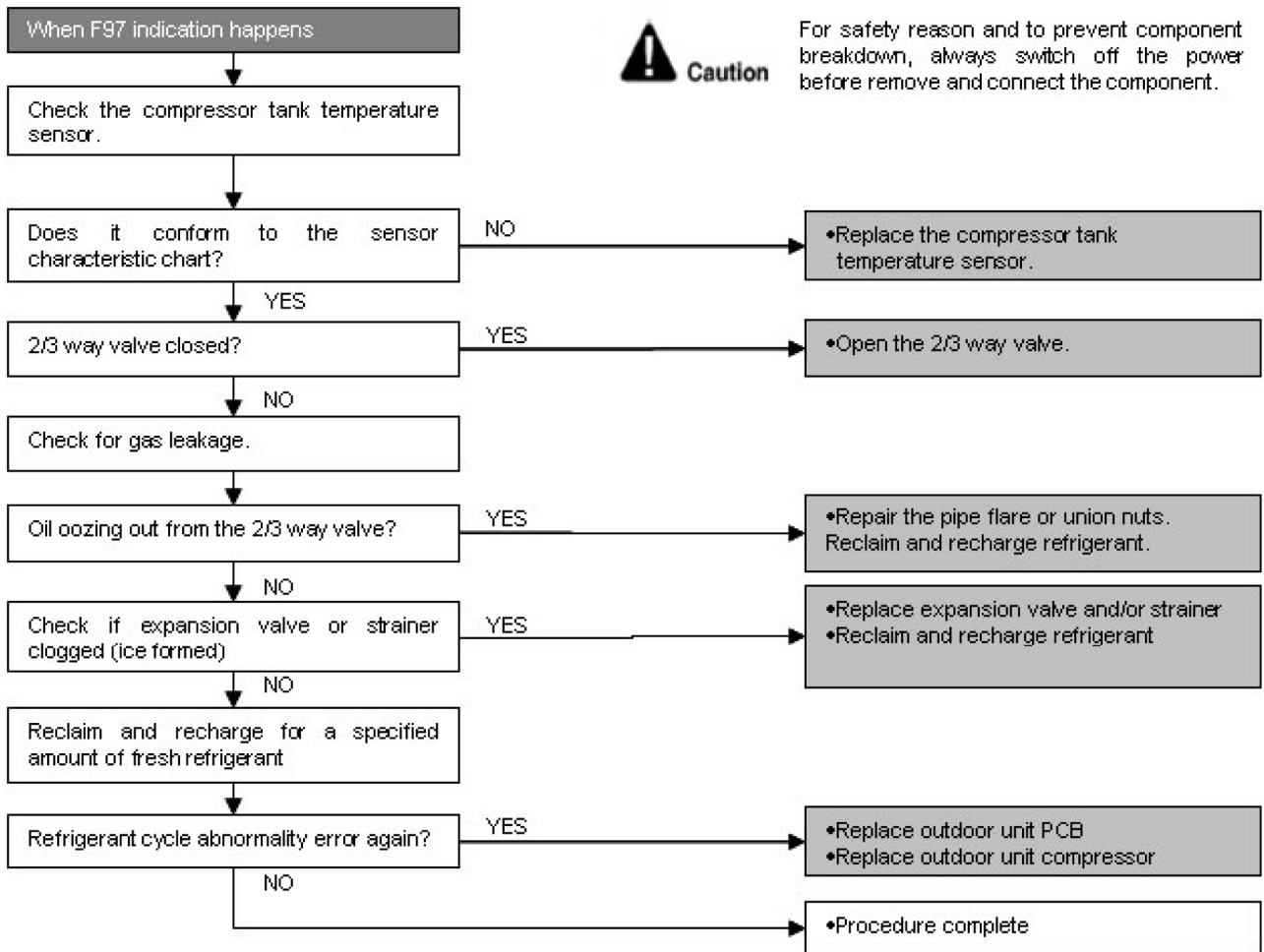

18.4.28 F98 (Input Over Current Detection)

Malfunction Decision Conditions

- During operation of cooling and heating, when an input over-current (X value in Total Running Current Control) is detected by checking the input current value being detected by current transformer (CT) with the compressor running.

Malfunction Caused

- Excessive refrigerant.
- Faulty outdoor unit PCB.

Troubleshooting

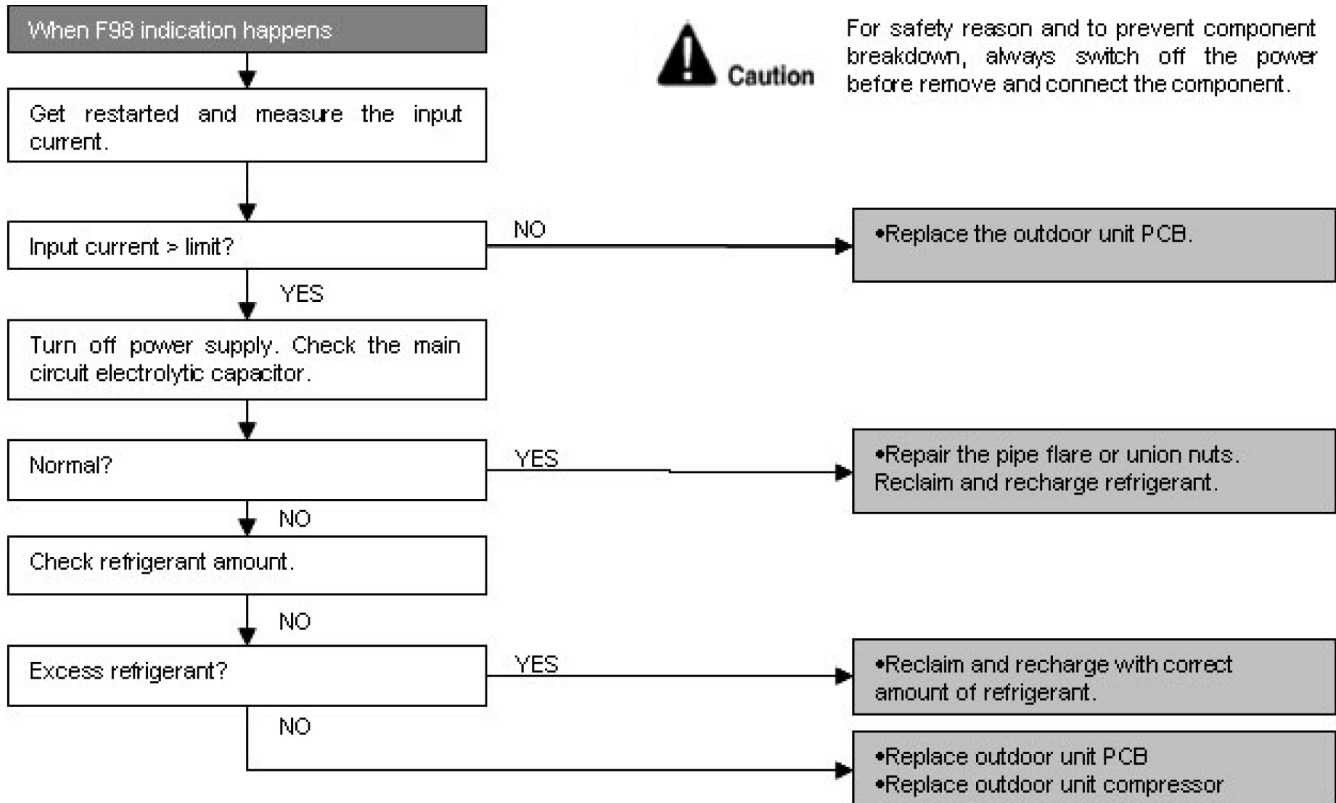

18.4.29 F99 (DC Peak Detection)

Malfunction Decision Conditions

During startup and operation of cooling and heating, when inverter DC peak data is received by the outdoor internal DC Peak sensing circuitry.

Malfunction Caused

- DC current peak due to compressor failure.
- DC current peak due to defective power transistor(s).
- DC current peak due to defective outdoor unit PCB.
- DC current peak due to short circuit.

Troubleshooting

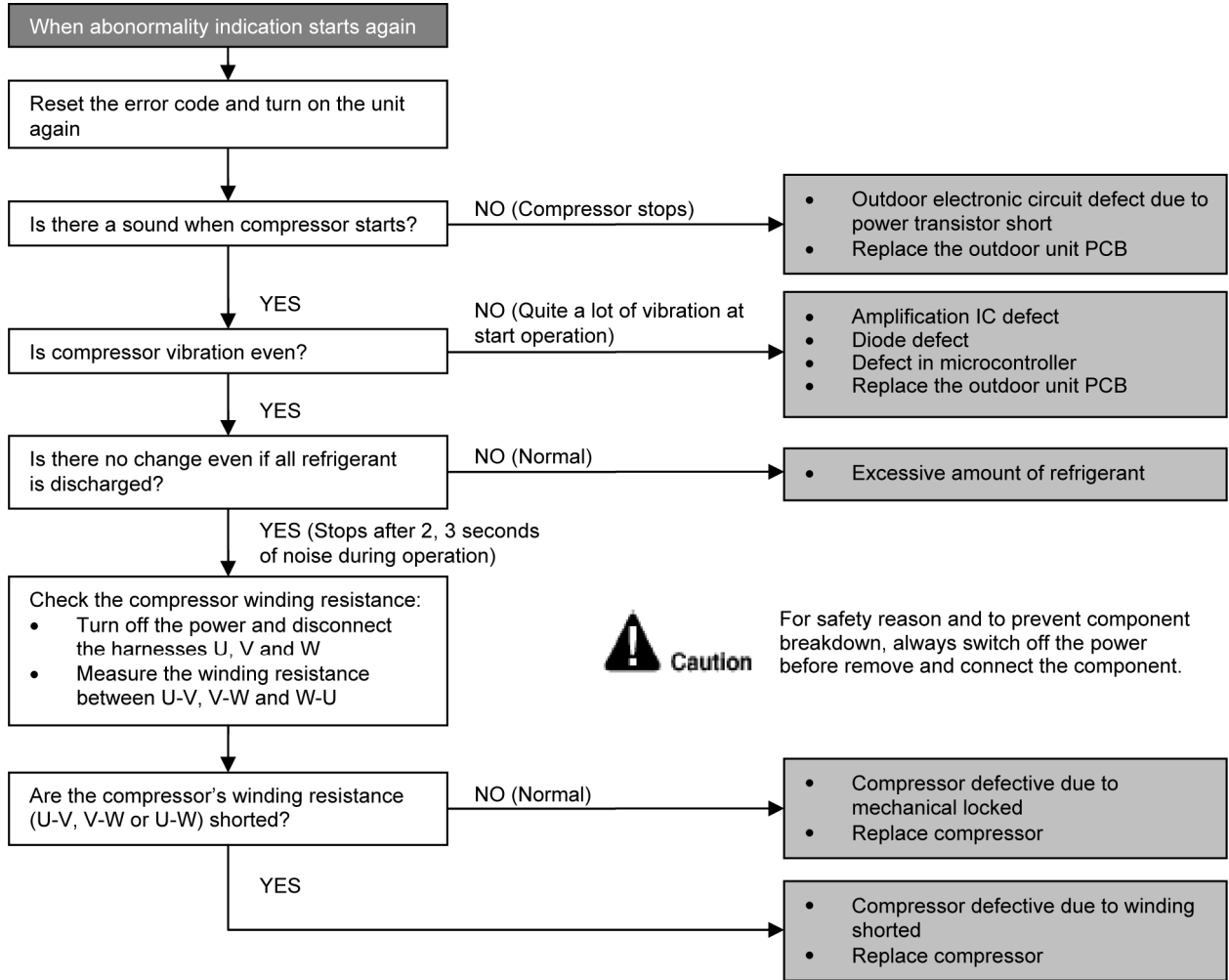

19. Disassembly and Assembly Instructions

 **WARNING**

High Voltage is generated in the electrical parts area by the capacitor. Ensure that the capacitor has discharged sufficiently before proceeding with repair work. Failure to heed this caution may result in electric shocks.

19.1 Indoor Electronic Controllers, Cross Flow Fan and Indoor Fan Motor Removal Procedures

19.1.1 To Remove Front Grille

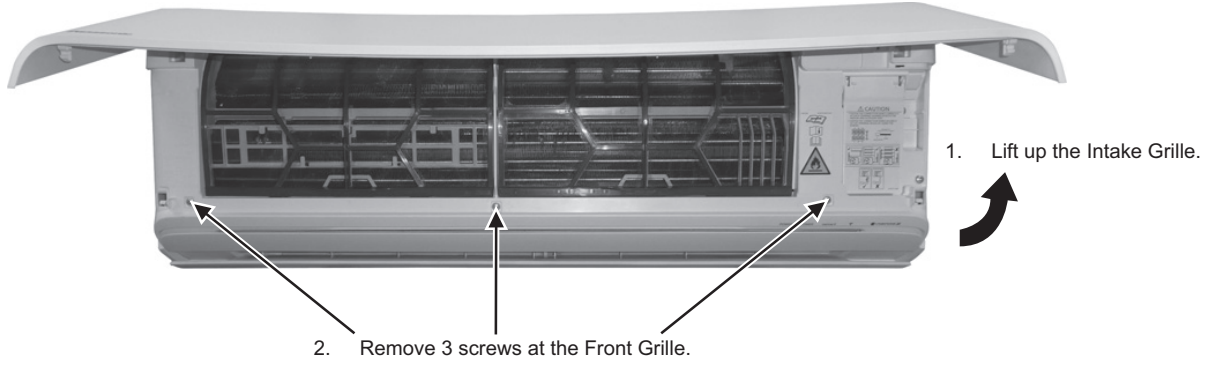

Figure 1

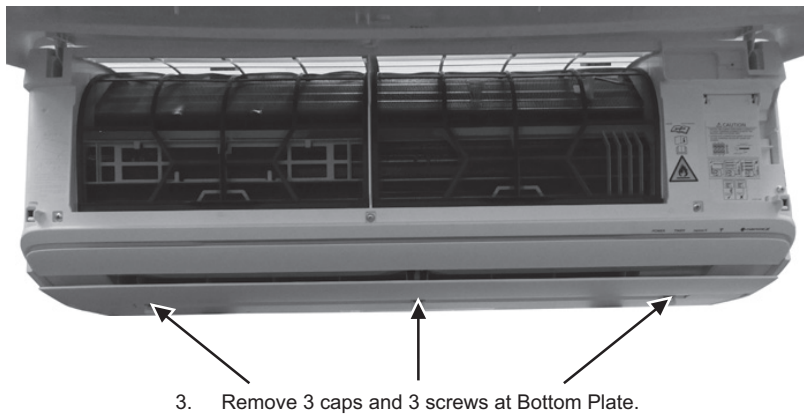

Figure 2

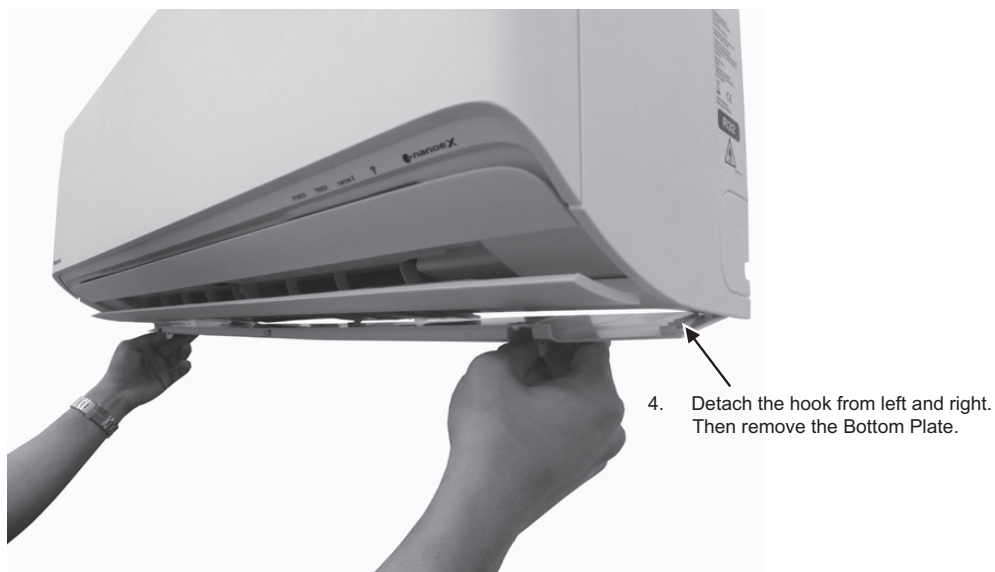

Figure 3

5. Open the hooks on top of the Front Grille.

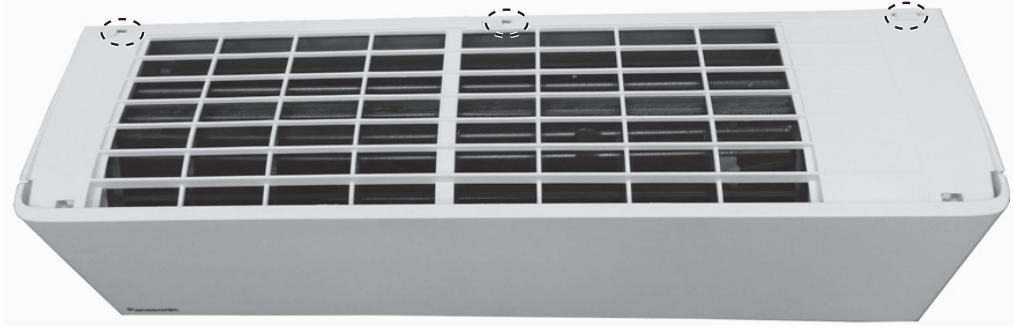

Figure 4

6. Remove the Front Grille.



Figure 5

19.1.2 To Remove Electronic Controller

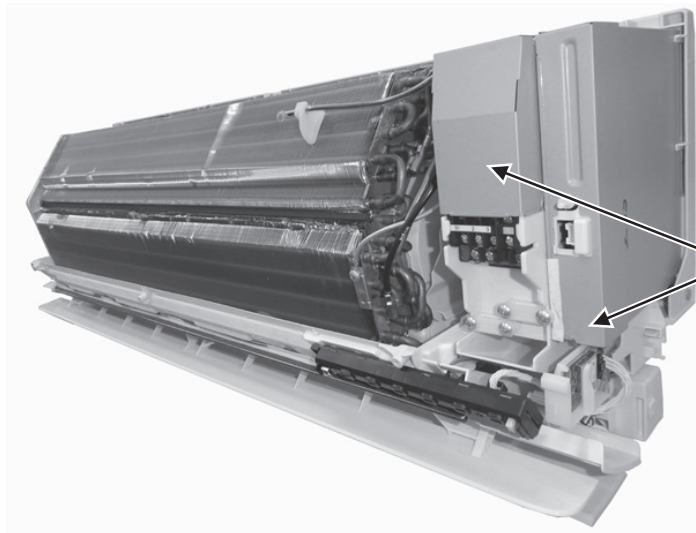

1. Remove the right side front cover first, then remove the second front cover.

Figure 6

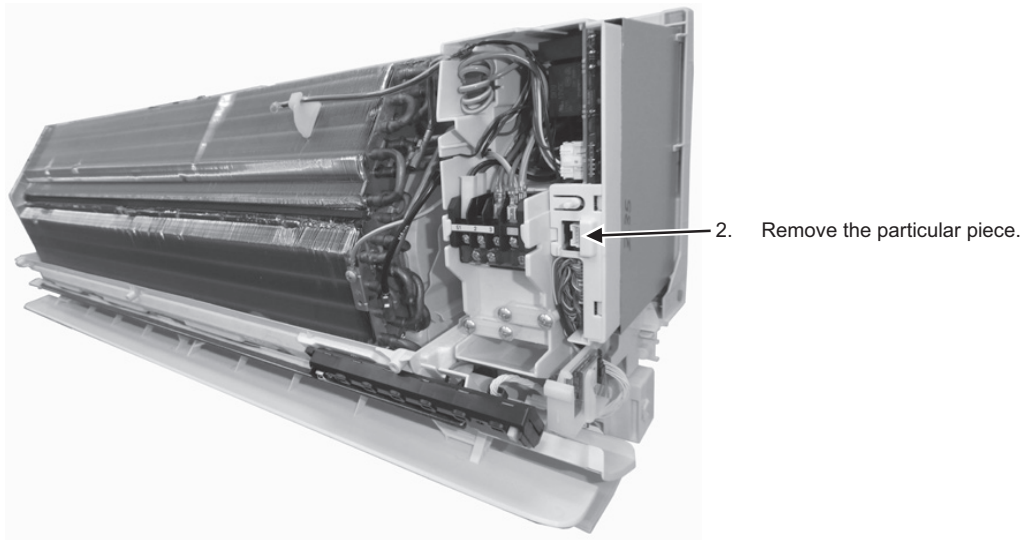

Figure 7

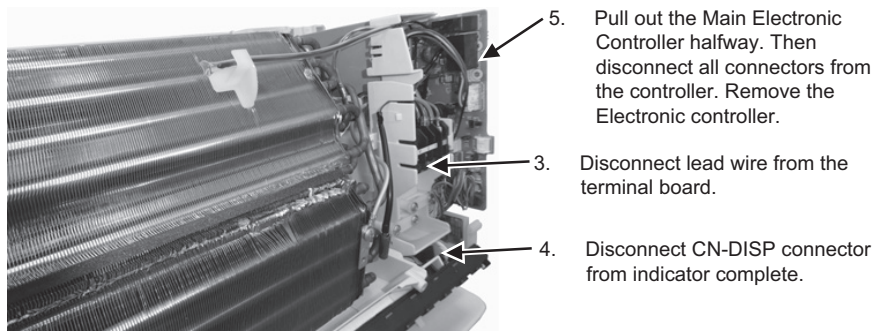

Figure 8

19.1.3 To Remove Discharge Grille

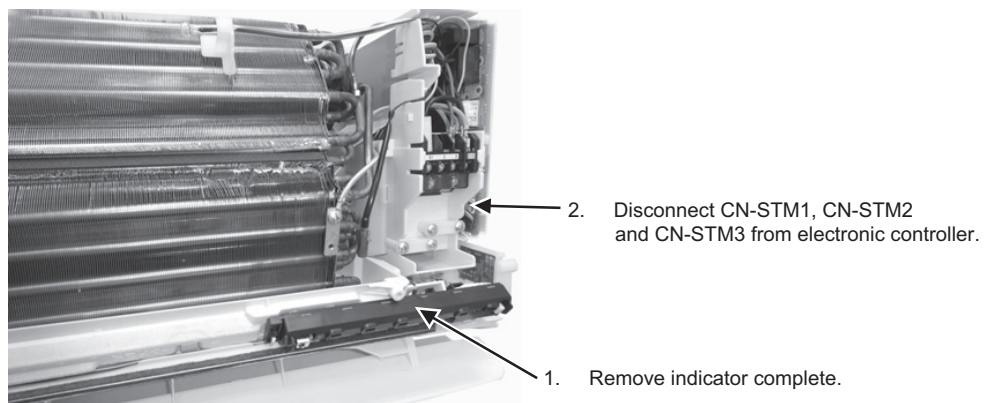

Figure 9

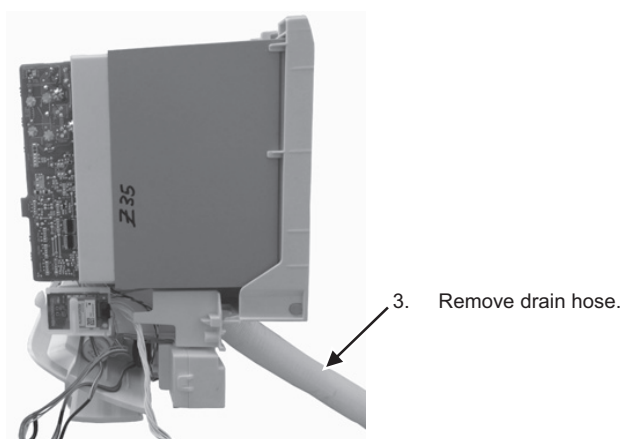

Figure 10

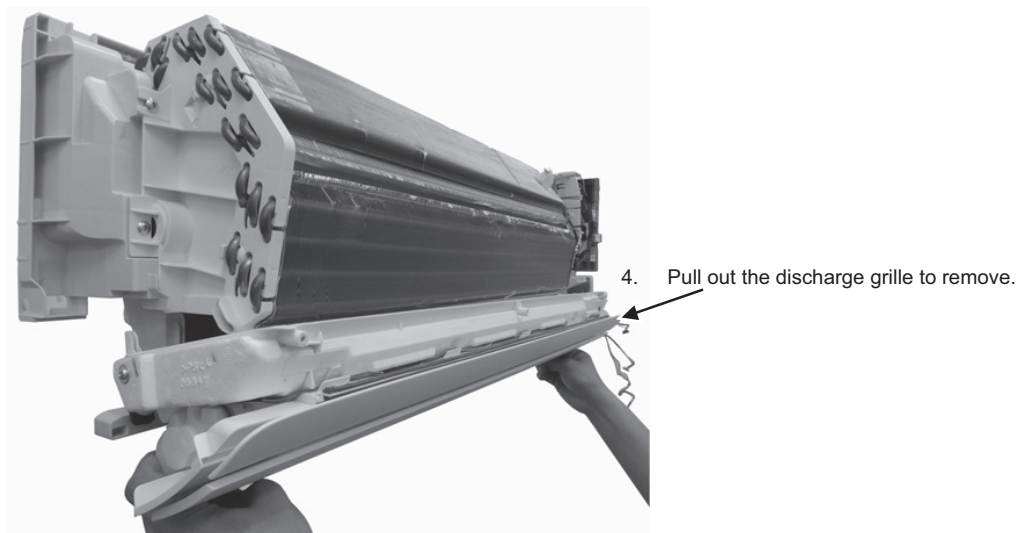

Figure 11

19.1.4 To Remove Cross Flow Fan

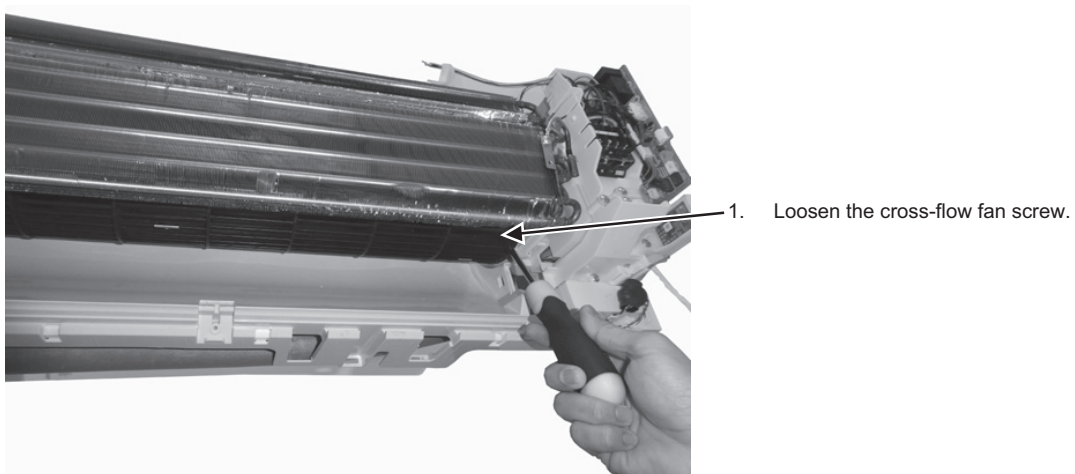

Figure 12

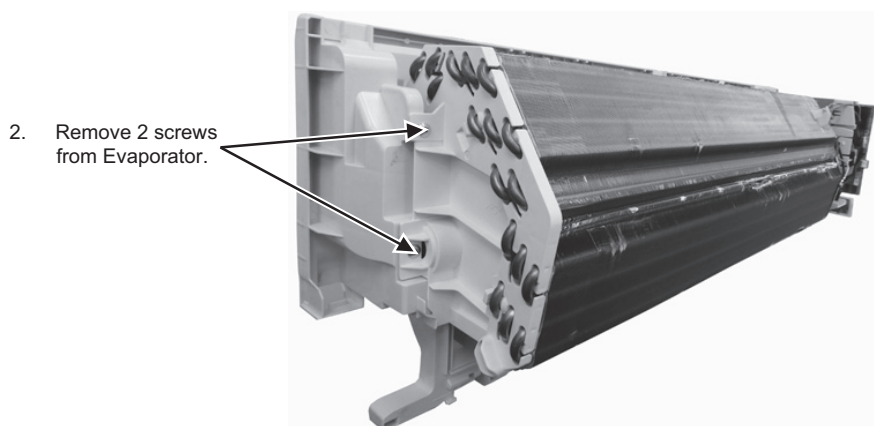

Figure 13

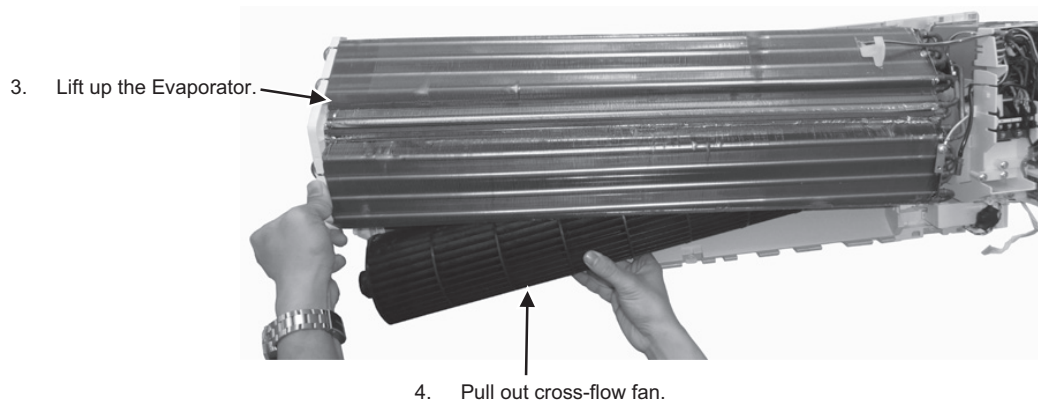
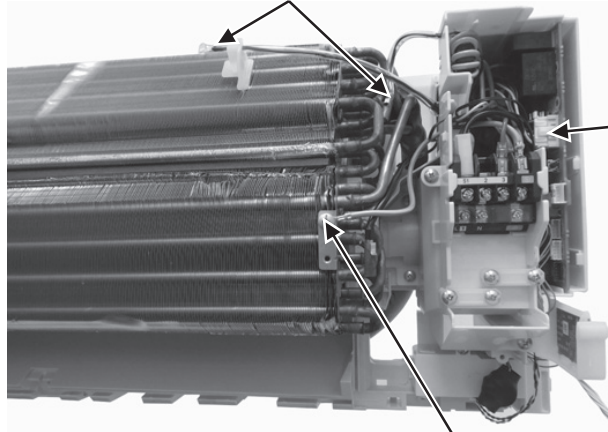

Figure 14

19.1.5 To Remove Fan Motor

3. Remove air temperature and pipe temperature sensor.



1. Disconnect CN-FM from electronic controller.

2. Remove earth wire from evaporator.

Figure 15

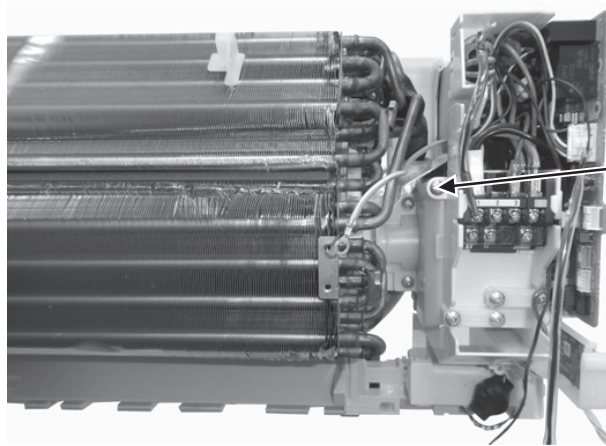

4. Remove 1 screw from control board complete. Then pull out the control board complete.

Figure 16

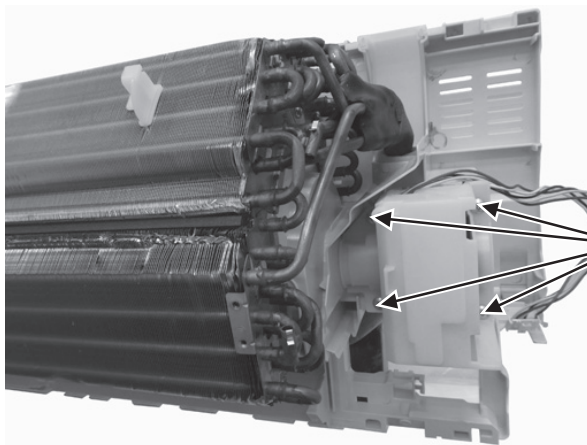

5. Remove 4 screws from fan motor cover.

Figure 17

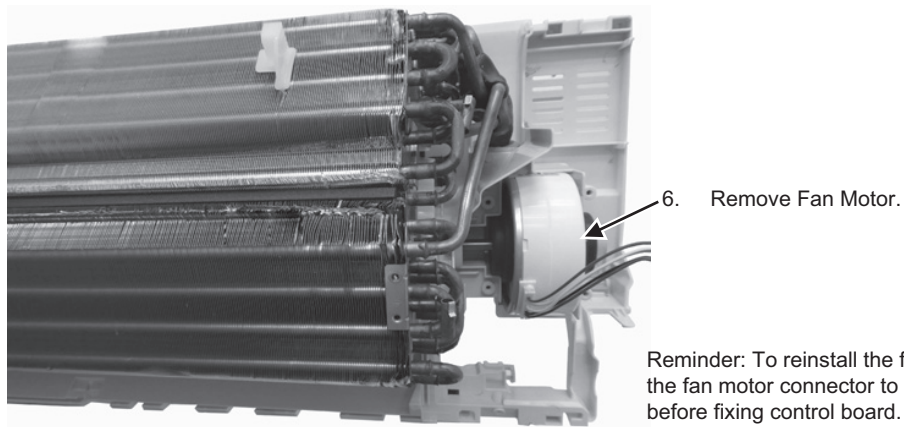

Figure 18

19.1.6 To Remove NanoeX

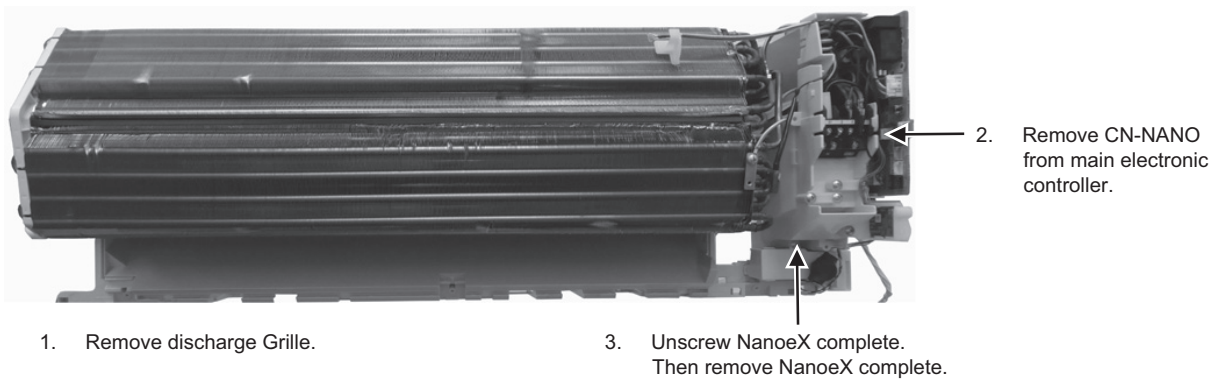
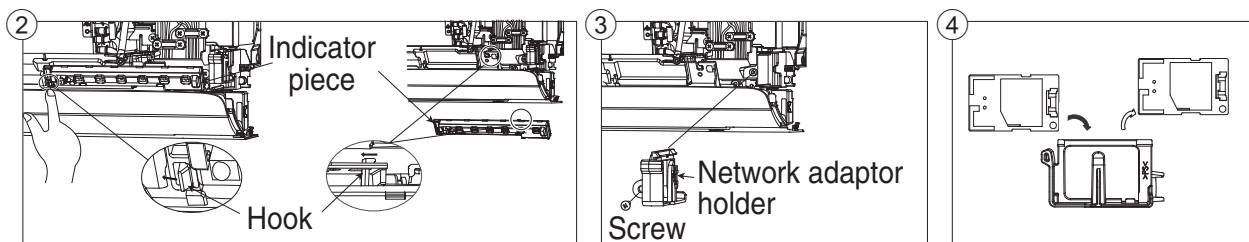

Figure 19

19.1.7 To Replace Wireless LAN Module (Network Adapter)

- 1 Remove the front grille (refer how to take out front grille) from the unit.
- 2 Remove the indicator piece by releasing the hook.
- 3 Remove 1 mounting screw, then remove the network adaptor holder.
- 4 After that, network adaptor can be easily replaced.



Reminder: Serviceman or owner must setting again Panasonic Comfort Cloud app after replace Wireless LAN Module.

19.2 Outdoor Electronic Controller Removal Procedure

⚠ Caution! When handling electronic controller, be careful of electrostatic discharge.

- 1 Remove the 5 screws of the Top Panel.

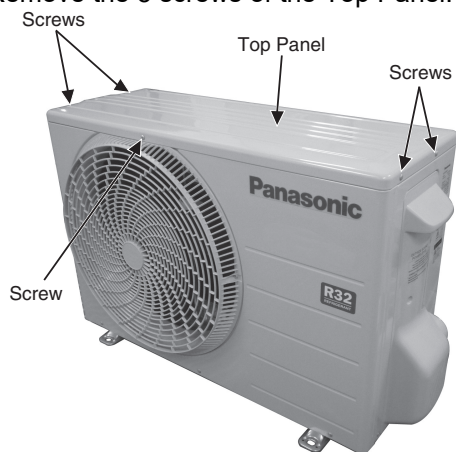

Fig. 1

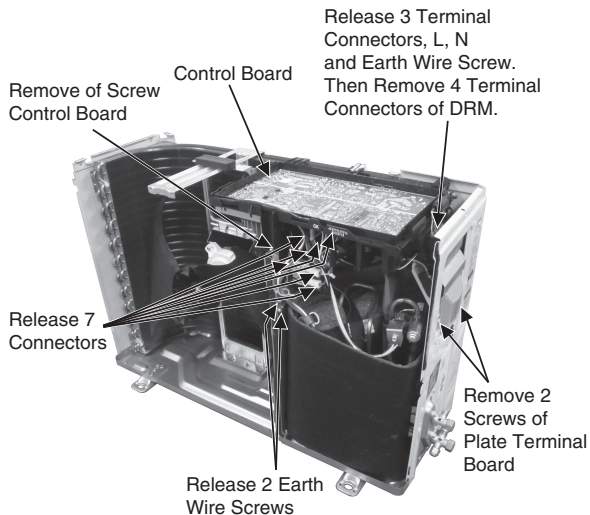

Fig. 4

- 2 Remove the 6 screws of the Front Panel.

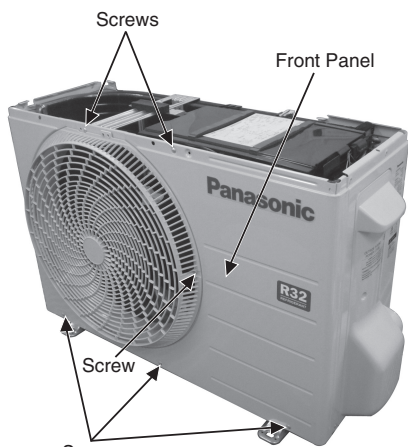

Fig. 2

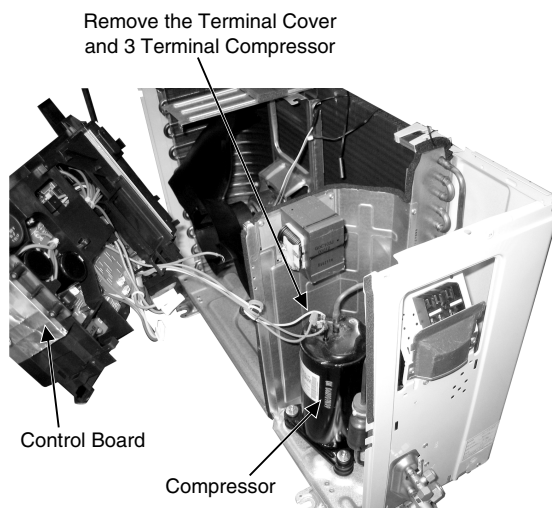

Fig. 5

- 3 Remove the screw of the Terminal Board Cover.
- 4 Remove the Top Cover of the Control Board by 4 hooks.

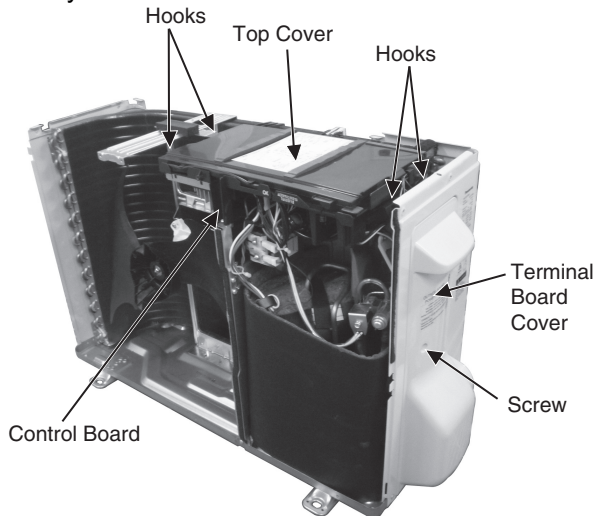

Fig. 3

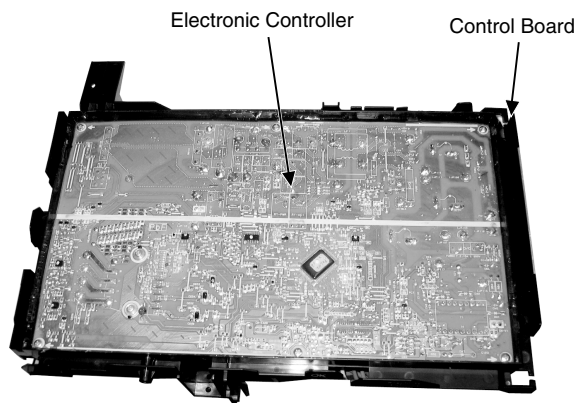

Fig. 6

- 5 Remove the Control Board as follows:

19.3 Panasonic Comfort Cloud

19.3.1 Starting “Panasonic Comfort Cloud”

Create New Panasonic ID

Use “Panasonic Comfort Cloud” app as an option to control this product.

The screenshot shows the 'Login' screen of the Panasonic Comfort Cloud app. At the top, it says 'Login'. Below that, it prompts the user to 'Please enter your Panasonic ID and password.' There are two input fields: 'Panasonic ID' and 'Password'. Below the password field is a checkbox for 'Remember me'. There are also links for 'Forgot ID/Password', 'Create new Panasonic ID', and 'View an example'. At the bottom, there is a 'Login' button.

- For new user, select “Create new Panasonic ID” to register.
- For registered user, log in using your Panasonic ID and password.

19.3.2 App Setting

Add new air conditioner

• Before using the “Panasonic Comfort Cloud” app, you need to register this product.

The sequence of screenshots shows the process of adding a new air conditioner:

- Step 1:** The 'Home' screen shows a thermostat for 'Bedroom 1' set to 30.0°C ON. A dashed box with a plus sign indicates where to tap to add a new device.
- Step 2:** The 'Add new device' screen asks 'Which appliances do you want to add?'. The 'Air conditioner' option is selected and highlighted with a dashed box.
- Step 3:** The 'Add new air conditioner' screen asks 'Please choose the following:'. Two options are shown: 'Built-in wireless module' (highlighted with a dashed box) and 'External wireless adaptor'.
- Step 4:** The 'Add new air conditioner' screen provides instructions for setting up the wireless LAN. It says: 'Follow the guide to set up Wireless LAN of the air-conditioner.' and lists two steps: '1. Connect air-conditioner to the server via wireless LAN router.' and '2. Use smartphone to register air-conditioner to the server.' The 'Start' button is highlighted with a dashed box.
- Step 5:** The 'Add new air conditioner' screen asks 'Please choose the following:'. Two options are shown: 'Newly purchased air-conditioner' (highlighted with a dashed box) and 'Others (Air-conditioner used before)'.

Setting connection network

- ① Check that the Wireless LAN LED is ON. Point the remote control to the air conditioner and press the Wireless LAN  button until the Wireless LAN LED starts blinking.

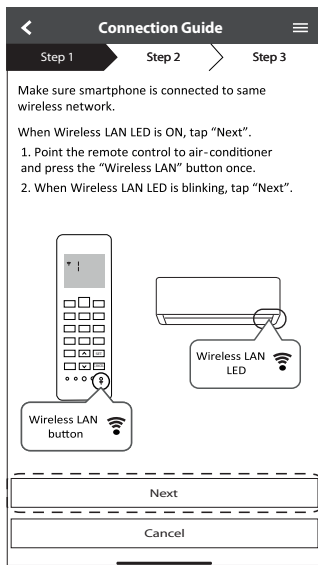

Fast blink	The unit is establishing the connection.
Slow blink	The unit is not securing the connection.
No blink (stays on)	The unit has established the connection.

- It can establish the connection to the unit even if the unit is turned OFF.

Note

- If the Wireless LAN LED blinks continuously and you do not want to use the app, press the Wireless LAN  button to turn it off.

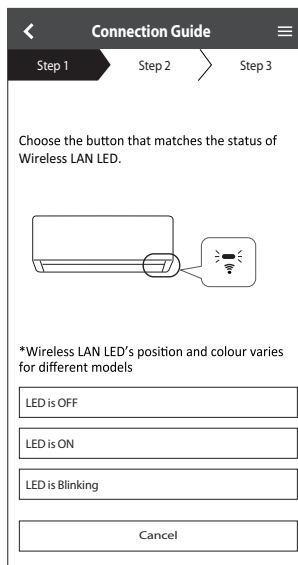

- ② Select the status of the Wireless LAN LED.

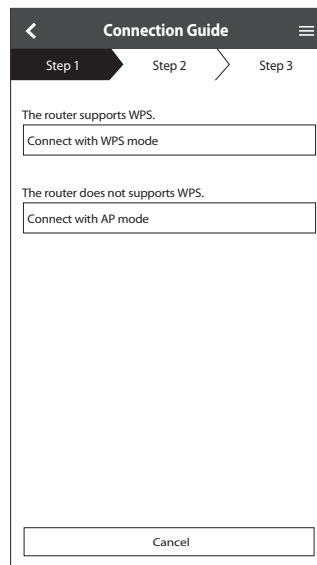

- ③ Select the preferred connection setup mode.



Connection network using WPS mode (method 1)

- ① Press the WPS button on the router that will be connected to the air conditioner.
 - Check that the Wireless LAN LED is ON.
 - If the Wireless LAN LED is OFF, press the Wireless LAN  button to turn it on, and enable Wireless LAN connection.
- ② Check that the Wireless LAN LED is ON. Press the Wireless LAN  button for 5 seconds until "1" appears on the remote control. Point the remote control to the air conditioner and press .

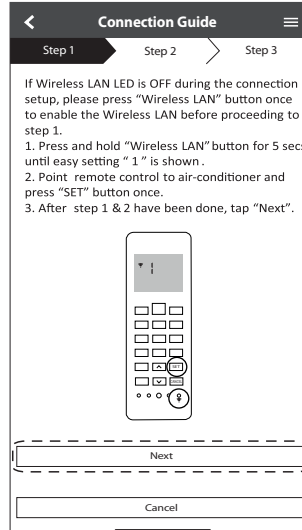
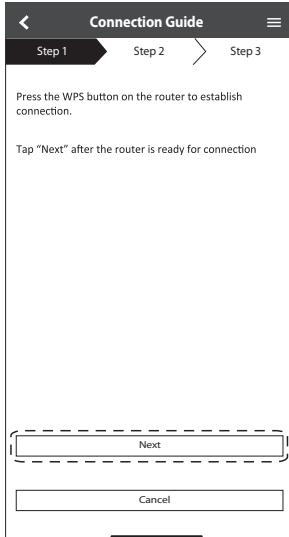

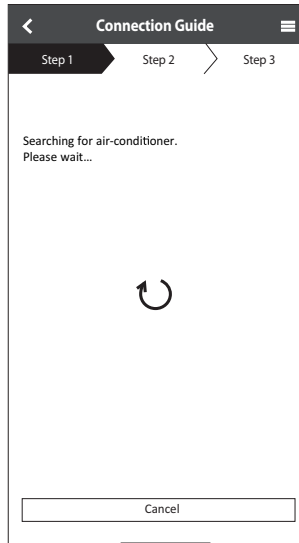
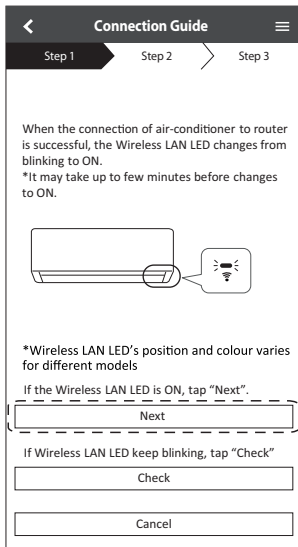

- ③ When the air conditioner is successfully connected to the router, the Wireless LAN LED stops blinking and turns ON.
- ④ If the Wireless LAN LED keeps blinking, check the wireless router connection.



Connection network using AP mode (method 2) (For Android 5.0 and above & iOS 11 and above only)

- ① Check that the Wireless LAN LED is ON. Press the Wireless LAN  button for 5 seconds until “1” appears on the remote control.

Press  until “2” appears. Point the remote control to the air conditioner and press . Join to connect to the “Panasonic-CS-wirelessAP” network.

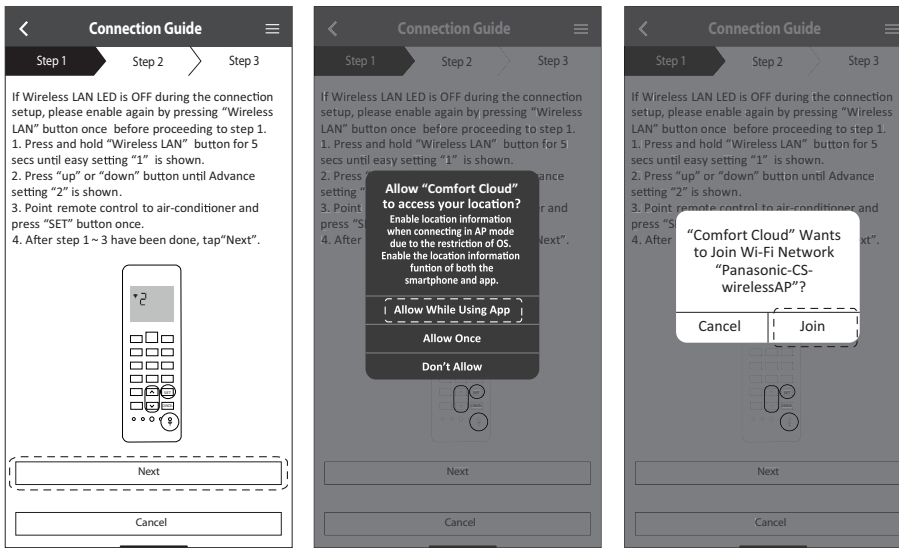

- ② Enter the password of the selected wireless router and continue.

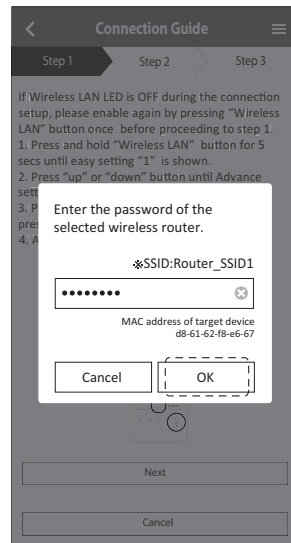

- ③ When the air conditioner is connected to the router successfully, the Wireless LAN LED stops blinking and turns ON. When the Wireless LAN LED is ON, connect your smartphone to the wireless router to continue the setup.
- If the Wireless LAN LED keeps blinking, check the wireless router connection.

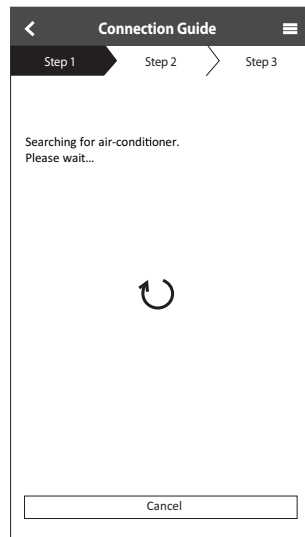
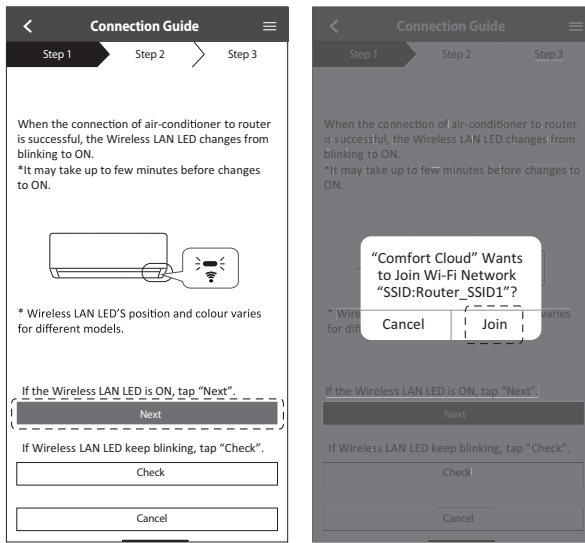

Select the air-conditioner and set the password

- ① Select the model to register your air-conditioner.

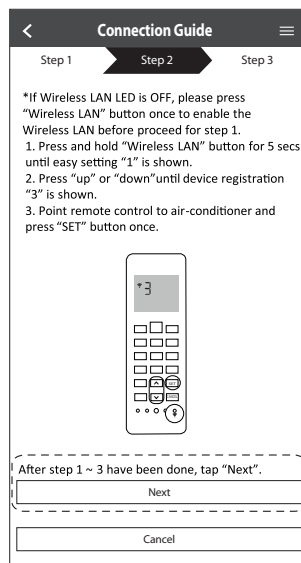
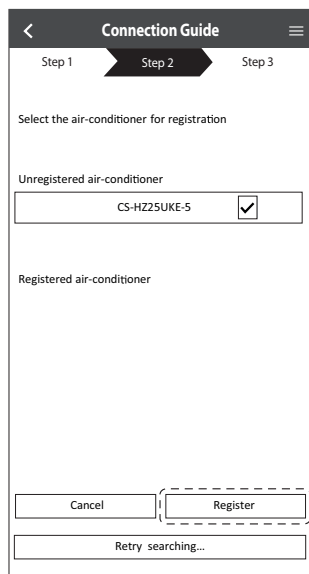

- ② Set a password to complete the registration. The password must be 8-15 characters with letters and numbers.

Note

- Keep the password for future use. You can use the same password when you register other Panasonic devices.

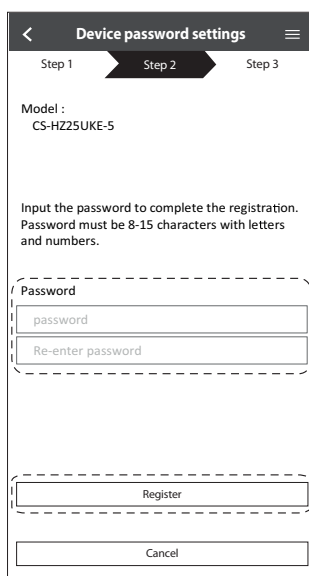

Registration completed

- ① After registration and connection is established between the app and your air conditioner, set the preferred name to identify your air conditioner easily.
 - After registering your preferred name for your air conditioner, you can use the “Panasonic Comfort Cloud” app functions.
- ② Beside operation control, this application can monitor the estimated energy consumption and do comparison for different time frame by referring to the statistic's graph.

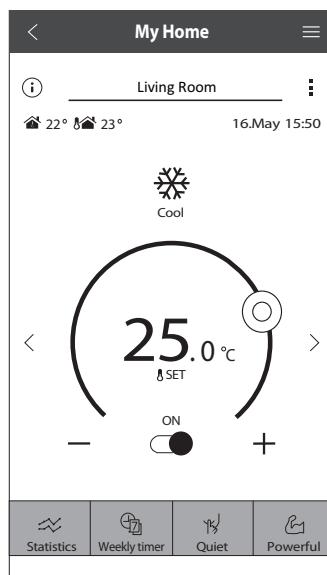
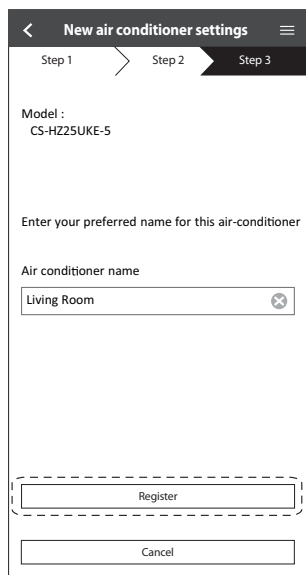

Note

- Check the app's connectivity status before and during operation. If the status is not reflected, use the remote control to operate your air conditioner.

19.3.3 Launch the App

- 1 Log in to the “Panasonic Comfort Cloud” app.
- 2 Select your air conditioner to control.

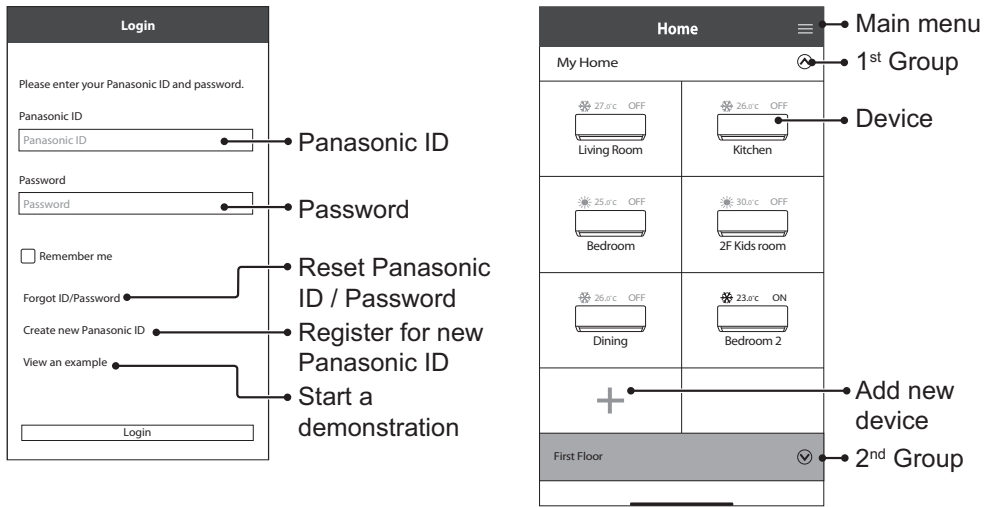

Main Device Screen - Operation Setting

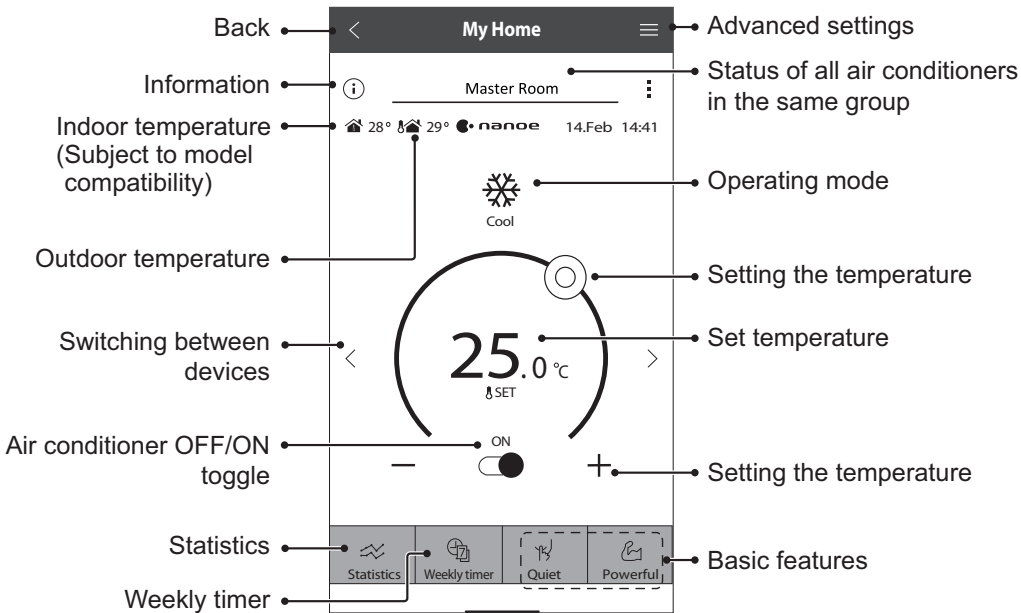

Information

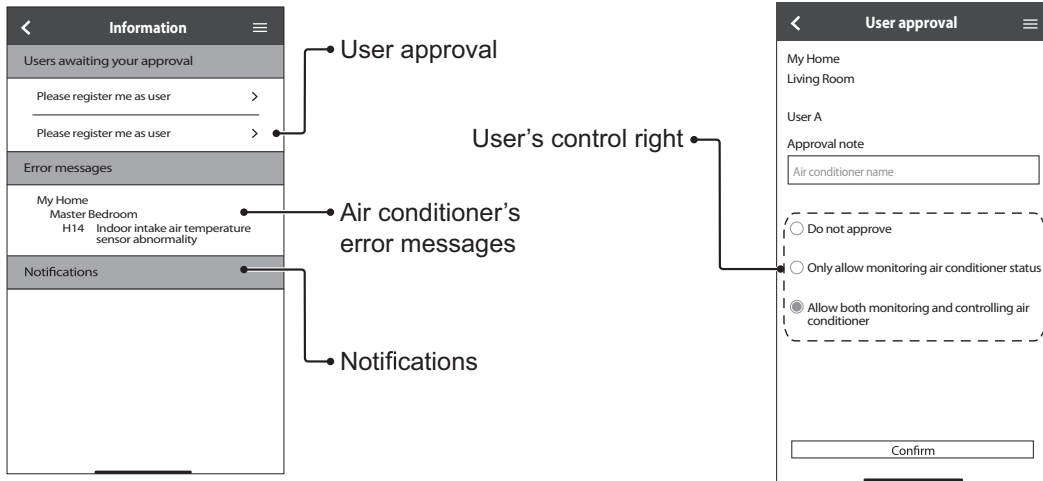

Air Conditioner Status

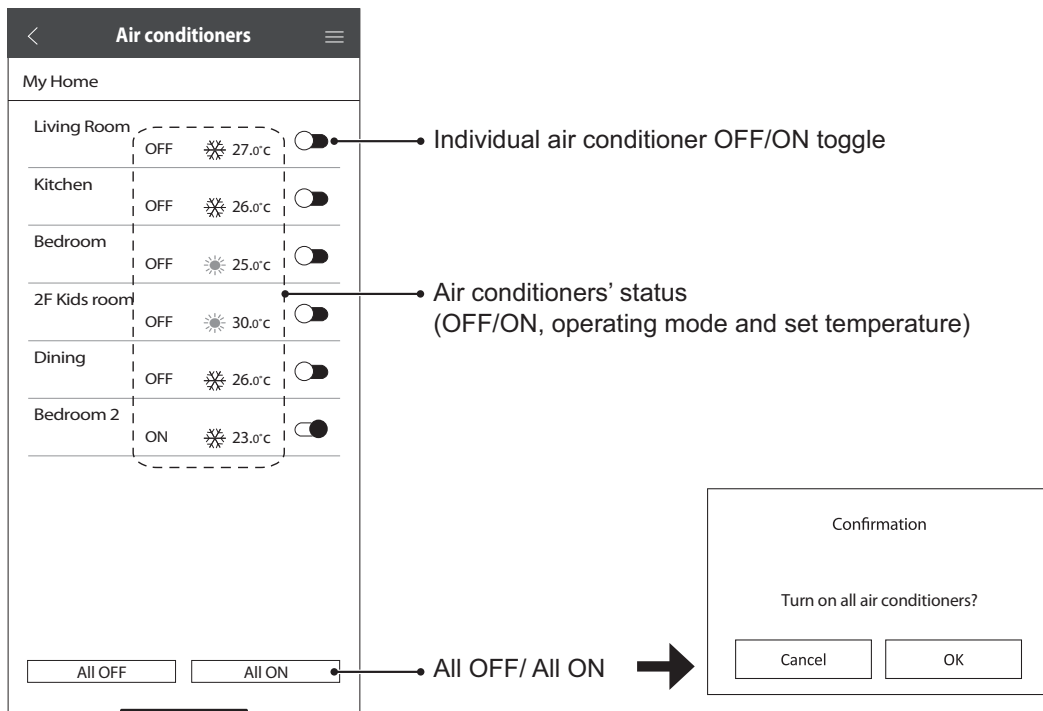

Advanced settings

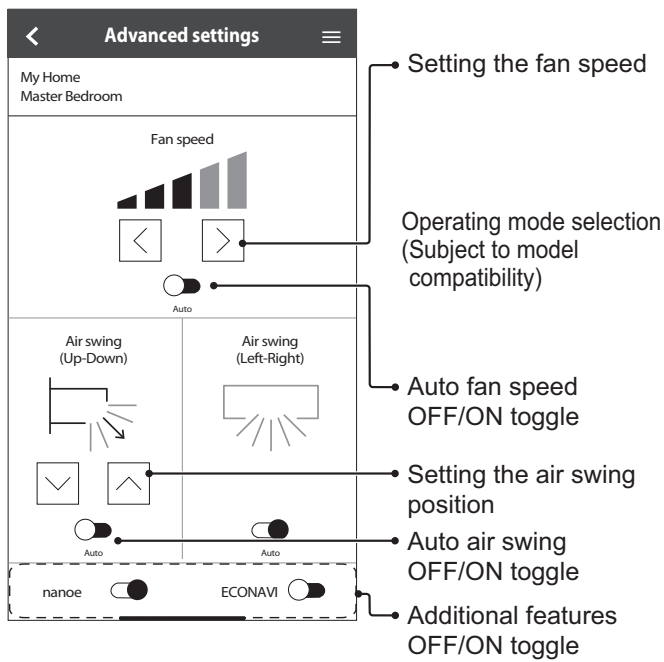

Operating mode

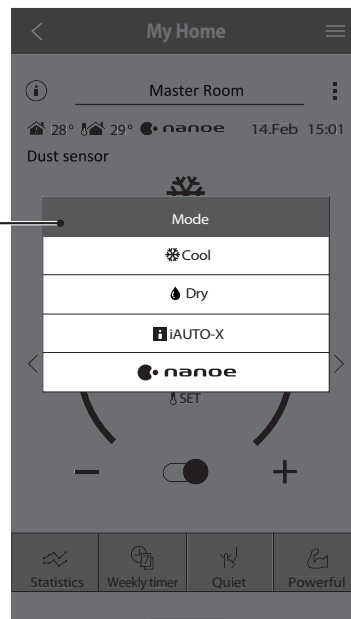

Statistics

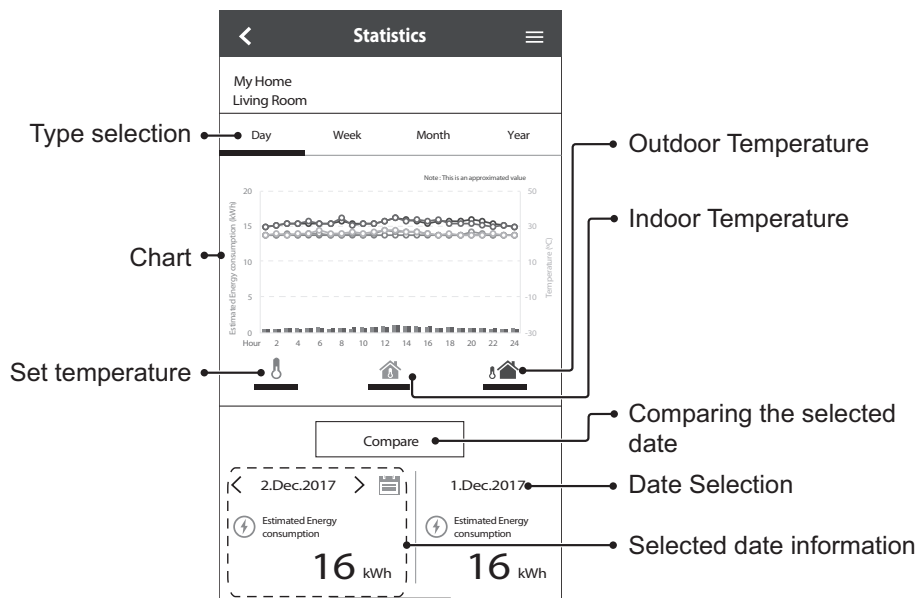

Note

- Estimated energy consumption may not be supported by certain models.
- For Multi-split AC system: energy consumption value displayed is for whole system.

Weekly Timer

① Tap “Weekly timer” to set the timer schedule.

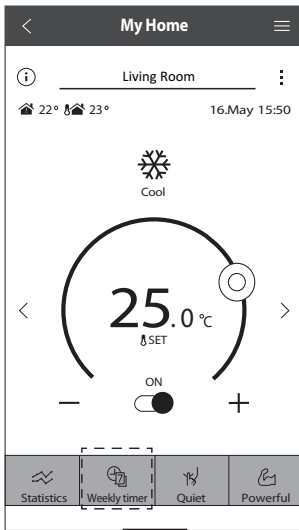

② Tap .

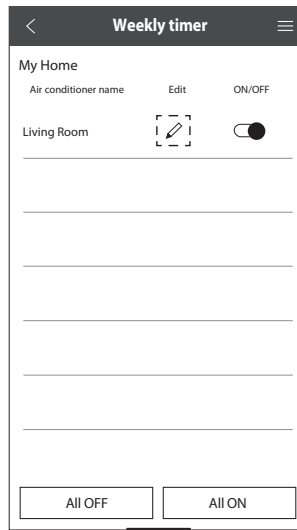

③ Tap  to add a new program. You can set a maximum of six programs for one day.

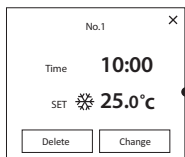

Edit timer

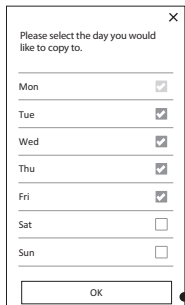

Copy timer

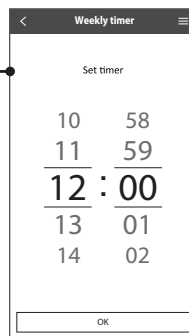
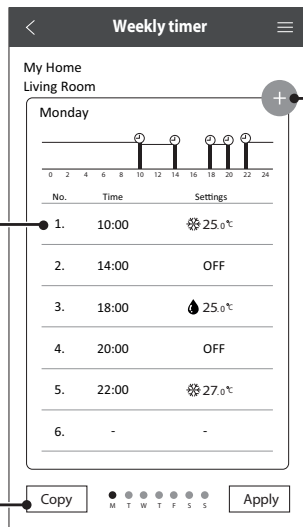

Set time

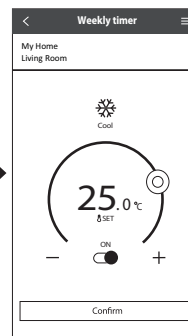

Set conditions

Main Menu

The main menu allows user to edit the device settings and provides important information.

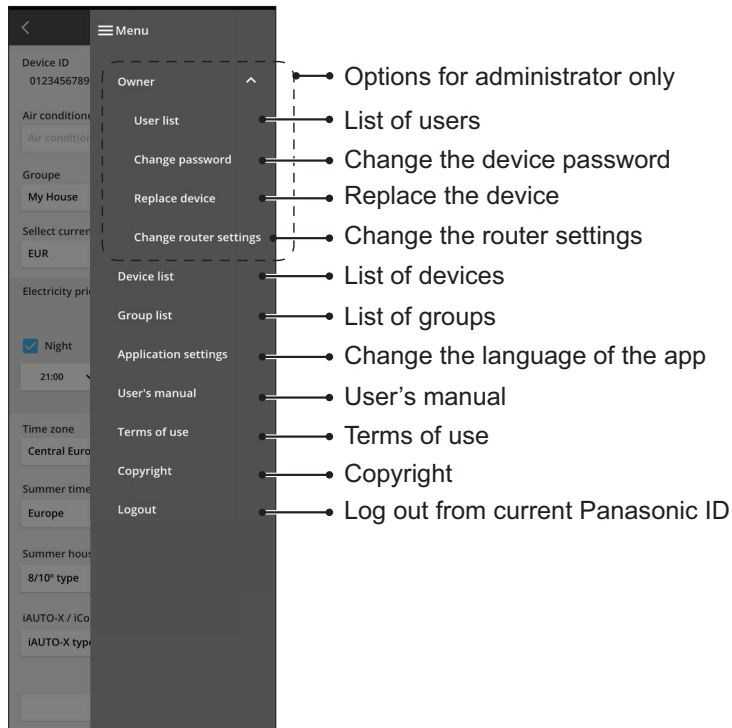

User List

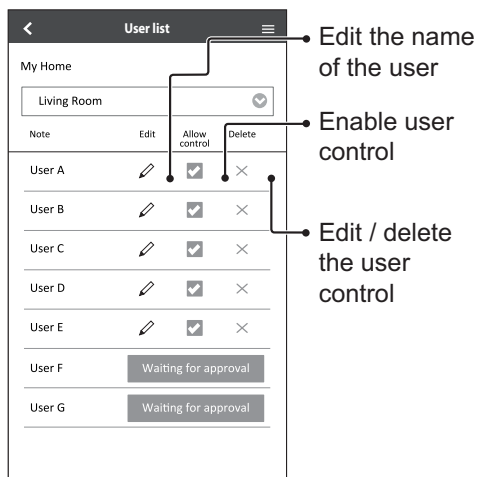

Change the Device Password

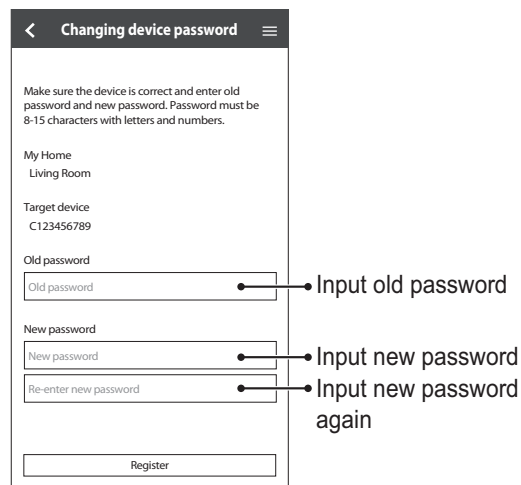

Replace the Device

- 1 Select "Replace device" from the menu.

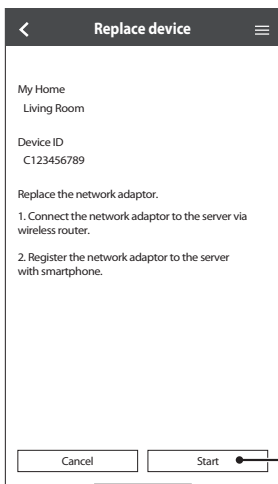

Tap Start

Change the Router Settings

- 2 Select "Change router settings" from the menu.

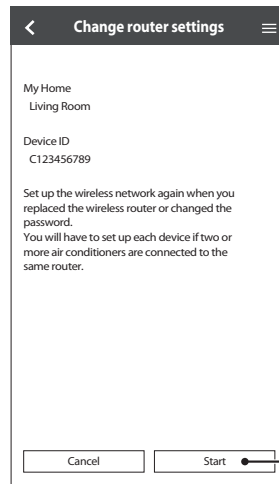

Tap Start

Device List

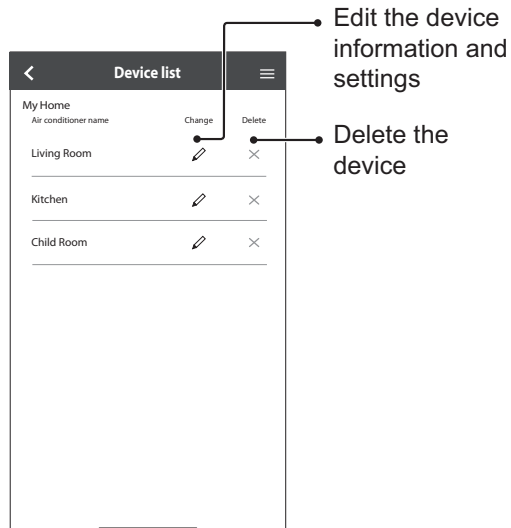

Edit the device information and settings

Delete the device

Group List

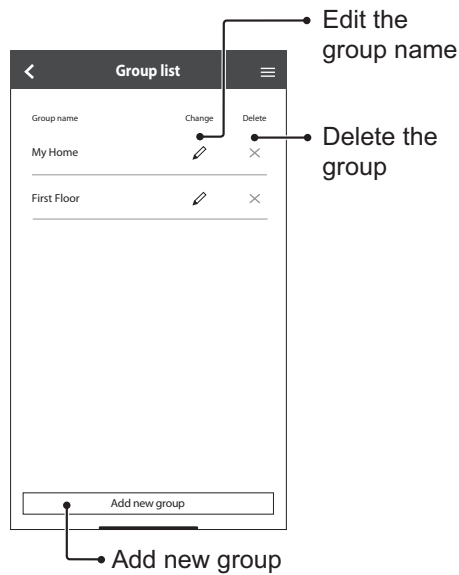

Edit the group name

Delete the group

Add new group

20. Technical Data

Technical data provided are based on the air conditioner running under free frequency.

20.1 Cool Mode Performance Data

Unit setting: Standard piping length, Hi Fan, Cool mode at 16°C Voltage: 230V

20.1.1 CS-Z20XKEW/CU-Z20XKE CS-XZ20XKEW/CU-Z20XKE

Indoor (°C)		Outdoor DB (°C)																				
DB	WB	-10			-7			0			5			16			25			35		
		TC	SHC	IP	TC	SHC	IP	TC	SHC	IP	TC	SHC	IP	TC	SHC	IP	TC	SHC	IP	TC	SHC	IP
27	19.0	2355	2224	368	2489	2148	422	2329	2306	382	2281	2237	396	2445	2275	243	2274	2110	340	2050	2030	450
	22.0	2589	1718	373	2590	1701	372	2688	1743	361	2548	1697	425	2715	1744	223	2484	1642	332	2377	1633	446
23	15.7	2148	2089	369	2259	2146	362	2129	2108	345	2098	2077	357	2234	2134	258	2173	2141	344	2020	2000	453
	18.4	2205	1608	402	2394	1648	393	2274	1650	375	2225	1636	386	2385	1659	249	2269	1638	341	2151	1598	449
20	13.3	2022	1984	334	1992	1879	361	1978	1958	335	1931	1912	334	2031	1957	254	2112	2010	347	1896	1877	451
	15.8	2099	1570	361	2088	1566	378	2004	1551	353	2015	1555	353	2138	1581	246	2125	1549	349	1977	1527	452

(Dry bulb value based on 46% humidity)

20.1.2 CS-Z25XKEW/CU-Z25XKE CS-XZ25XKEW/CU-Z25XKE

Indoor (°C)		Outdoor DB (°C)																				
DB	WB	-10			-7			0			5			16			25			35		
		TC	SHC	IP	TC	SHC	IP	TC	SHC	IP	TC	SHC	IP	TC	SHC	IP	TC	SHC	IP	TC	SHC	IP
27	19.0	2900	2711	417	3065	2618	479	2869	2811	433	2809	2727	449	3011	2773	276	2800	2572	385	2500	2450	510
	22.0	3189	2094	423	3190	2074	421	3310	2124	409	3138	2069	482	3343	2126	253	3058	2002	377	2927	1991	506
23	15.7	2646	2546	418	2782	2615	410	2622	2569	391	2584	2532	405	2751	2601	292	2676	2610	389	2487	2438	513
	18.4	2715	1961	455	2948	2009	446	2800	2011	425	2740	1995	437	2937	2022	282	2795	1997	386	2649	1948	509
20	13.3	2491	2418	379	2453	2291	409	2436	2387	379	2378	2331	379	2501	2386	288	2600	2450	393	2335	2289	511
	15.8	2584	1914	409	2572	1908	428	2468	1891	400	2481	1896	400	2633	1928	279	2616	1889	395	2435	1862	512

(Dry bulb value based on 46% humidity)

20.1.3 CS-Z35XKEW/CU-Z35XKE CS-XZ35XKEW/CU-Z35XKE

Indoor (°C)		Outdoor DB (°C)																				
DB	WB	-10			-7			0			5			16			25			35		
		TC	SHC	IP	TC	SHC	IP	TC	SHC	IP	TC	SHC	IP	TC	SHC	IP	TC	SHC	IP	TC	SHC	IP
27	19.0	3943	3420	669	4261	3295	603	4228	3348	648	3991	3298	582	4257	3424	472	4137	3404	638	3500	3075	850
	22.0	4691	2380	560	4351	2435	670	4657	2586	549	4460	2529	621	4786	2642	449	4516	2509	634	4000	2347	825
23	15.7	3803	3263	679	3518	3195	674	3675	3191	620	3625	3161	631	3898	3335	494	3663	3238	651	3291	3035	822
	18.4	3825	2431	679	3860	2431	663	3981	2467	657	3956	2492	658	4395	2578	481	4038	2502	642	3498	2272	821
20	13.3	3122	2969	597	3187	3003	707	3250	2991	707	3492	3144	611	3665	3200	505	3347	3071	650	3028	2924	821
	15.8	3347	2288	729	3516	2362	653	3722	2449	618	3732	2468	636	4032	2573	495	3660	2417	647	3258	2226	822

(Dry bulb value based on 46% humidity)

20.1.4 CS-Z42XKEW/CU-Z42XKE

Indoor (°C)		Outdoor DB (°C)																				
DB	WB	-10			-7			0			5			16			25			35		
		TC	SHC	IP	TC	SHC	IP	TC	SHC	IP	TC	SHC	IP	TC	SHC	IP	TC	SHC	IP	TC	SHC	IP
27	19.0	4826	4007	980	5216	3862	883	5175	3923	948	4885	3865	852	5211	4012	692	5064	3989	934	4200	3533	1240
	22.0	5742	2789	820	5326	2854	981	5701	3030	804	5459	2963	909	5858	3097	657	5528	2940	929	4896	2751	1208
23	15.7	4655	3824	995	4306	3744	986	4498	3740	907	4437	3705	923	4771	3908	723	4484	3795	953	4029	3557	1203
	18.4	4682	2849	994	4725	2848	971	4872	2891	962	4842	2920	964	5379	3021	705	4943	2932	941	4281	2662	1202
20	13.3	3822	3479	874	3901	3519	1035	3978	3505	1035	4274	3684	895	4486	3750	739	4096	3599	952	3706	3426	1202
	15.8	4097	2681	1067	4303	2768	955	4556	2870	905	4568	2892	931	4935	3016	725	4479	2832	947	3988	2608	1203

(Dry bulb value based on 46% humidity)

20.1.5 CS-Z50XKEW/CU-Z50XKE CS-XZ50XKEW/CU-Z50XKE

Indoor (°C)		Outdoor DB (°C)																				
DB	WB	-10			-7			0			5			16			25			35		
		TC	SHC	IP	TC	SHC	IP	TC	SHC	IP	TC	SHC	IP	TC	SHC	IP	TC	SHC	IP	TC	SHC	IP
27	19.0	5646	4533	1038	5762	4538	934	5808	4589	950	5729	4577	924	5859	4603	872	5439	4388	1103	5000	4246	1410
	22.0	6394	3701	914	6429	3695	854	6289	3664	982	6210	3582	974	6442	3669	833	5970	3467	1118	5501	3319	1428
23	15.7	5281	4531	940	5294	4546	867	5140	4450	975	5292	4556	898	5097	4370	900	4876	4204	1113	4542	4223	1410
	18.4	5718	3681	887	5728	3676	924	5536	3581	1031	5739	3665	930	5600	3499	877	5328	3452	1133	4949	3307	1423
20	13.3	4097	3956	774	4056	3986	824	3860	3821	646	3489	3454	524	4966	4916	920	4491	4101	1117	4219	4028	1407
	15.8	5140	3534	1017	4345	3115	807	4513	3156	777	4020	2976	553	5212	3478	897	4852	3346	1141	4498	3212	1423

(Dry bulb value based on 46% humidity)

20.1.6 CS-Z71XKEW/CU-Z71XKE

Indoor (°C)		Outdoor DB (°C)																				
DB	WB	-10			-7			0			5			16			25			35		
		TC	SHC	IP	TC	SHC	IP	TC	SHC	IP	TC	SHC	IP	TC	SHC	IP	TC	SHC	IP	TC	SHC	IP
27	19.0	8017	5673	1597	8181	5679	1438	8248	5742	1462	8135	5728	1422	8319	5761	1341	7724	5491	1697	7100	5313	2170
	22.0	9079	4631	1407	9129	4624	1315	8931	4585	1512	8818	4483	1499	9147	4591	1282	8477	4339	1720	7811	4154	2197
23	15.7	7499	5671	1447	7518	5689	1334	7298	5568	1500	7515	5701	1382	7238	5468	1386	6923	5262	1713	6450	5285	2170
	18.4	8119	4607	1365	8133	4601	1422	7860	4482	1587	8149	4586	1431	7953	4378	1349	7565	4321	1744	7027	4139	2191
20	13.3	5817	4950	1191	5760	4988	1268	5481	4964	995	4954	4470	806	7052	6981	1417	6377	5132	1719	5992	5041	2165
	15.8	7299	4423	1566	6170	3898	1241	6408	3949	1195	5709	3725	851	7402	4353	1381	6889	4187	1755	6387	4020	2190

(Dry bulb value based on 46% humidity)

TC - Total Cooling Capacity (W)
 SHC - Sensible Heat Capacity (W)
 IP - Input Power (W)

20.2 Heat Mode Performance Data

Unit setting: Standard piping length, Hi Fan, Heat mode at 30°C Voltage: 230V

20.2.1 CS-Z20XKEW/CU-Z20XKE CS-XZ20XKEW/CU-Z20XKE

Indoor (°C)	Outdoor WB (°C)									
	-15		-7		2		7		12	
	TC	IP	TC	IP	TC	IP	TC	IP	TC	IP
24	1884	805	2341	852	2777	822	2695	625	2983	630
20	1851	788	2380	840	2900	830	2800	620	3188	631
16	1856	812	2423	827	3052	817	2887	619	3211	626

20.2.2 CS-Z25XKEW/CU-Z25XKE CS-XZ25XKEW/CU-Z25XKE

Indoor (°C)	Outdoor WB (°C)									
	-15		-7		2		7		12	
	TC	IP	TC	IP	TC	IP	TC	IP	TC	IP
24	2396	895	2754	1014	3333	1030	3208	706	3551	712
20	2355	877	2800	1000	3480	1040	3400	700	3796	712
16	2362	903	2851	984	3663	1023	3437	698	3823	706

20.2.3 CS-Z35XKEW/CU-Z35XKE CS-XZ35XKEW/CU-Z35XKE

Indoor (°C)	Outdoor WB (°C)									
	-15		-7		2		7		12	
	TC	IP	TC	IP	TC	IP	TC	IP	TC	IP
24	2669	1198	3008	1261	3883	1297	3718	894	4006	905
20	2785	1166	3200	1260	3990	1290	4000	900	4320	903
16	2845	1121	3402	1257	4285	1290	4263	899	4628	897

20.2.4 CS-Z42XKEW/CU-Z42XKE

Indoor (°C)	Outdoor WB (°C)									
	-15		-7		2		7		12	
	TC	IP	TC	IP	TC	IP	TC	IP	TC	IP
24	3035	1407	3863	1601	4797	1659	4926	1431	5307	1447
20	3167	1369	4110	1600	4930	1650	5300	1440	5724	1445
16	3236	1316	4369	1596	5294	1650	5649	1438	6132	1435

20.2.5 CS-Z50XKEW/CU-Z50XKE CS-XZ50XKEW/CU-Z50XKE

Indoor (°C)	Outdoor WB (°C)									
	-15		-7		2		7		12	
	TC	IP	TC	IP	TC	IP	TC	IP	TC	IP
24	3983	1950	4352	2104	5583	2250	5441	1439	5597	1433
20	4117	1879	4800	2100	5800	2240	5800	1440	6054	1433
16	4448	1779	4964	2096	6226	1902	5713	1432	6475	1439

20.2.6 CS-Z71XKEW/CU-Z71XKE

Indoor (°C)	Outdoor WB (°C)									
	-15		-7		2		7		12	
	TC	IP	TC	IP	TC	IP	TC	IP	TC	IP
24	4538	2049	5721	2505	7114	2532	8068	2349	8298	2338
20	4690	1974	6310	2500	7390	2520	8600	2350	8977	2338
16	5067	1869	6526	2495	7933	2140	8471	2337	9601	2348

TC - Total Cooling Capacity (W)

SHC - Sensible Heat Capacity (W)

IP - Input Power (W)

21. Service Data

Service data provided are based on the air conditioner running under rated frequency during forced cooling / forced heating mode.

21.1 Cool Mode Outdoor Air Temperature Characteristic

Condition

- Indoor room temperature: 27°C Dry Bulb/19°C Wet Bulb
- Unit setting: Standard piping length, forced cooling at 16°C, Hi fan
- Compressor frequency: Rated for cooling operation
- Piping length: 5m
- Voltage: 230V

21.1.1 CS-Z20XKEW CU-Z20XKE CS-XZ20XKEW CU-Z20XKE

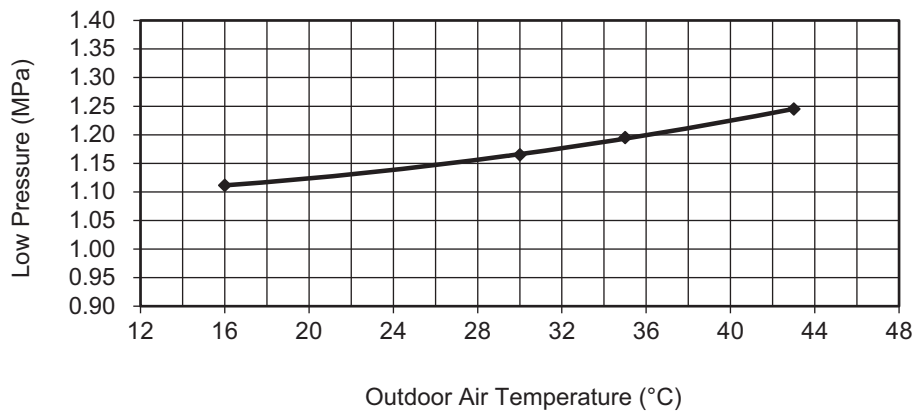
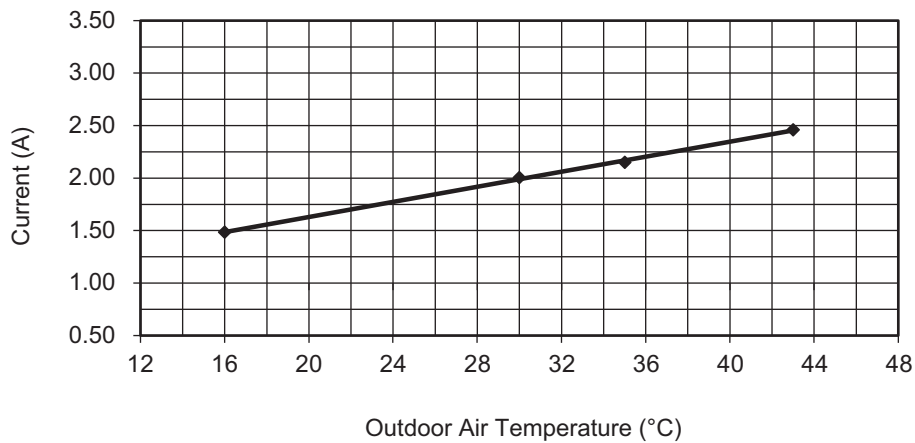
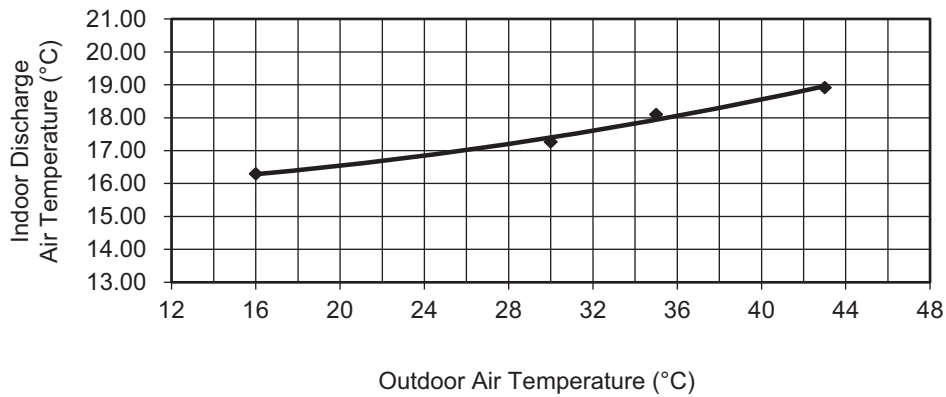

21.1.2 CS-Z25XKEW CU-Z25XKE CS-XZ25XKEW CU-Z25XKE

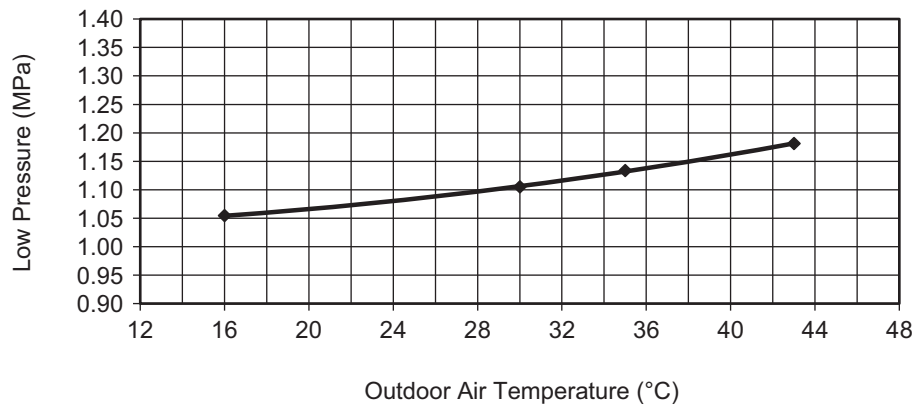
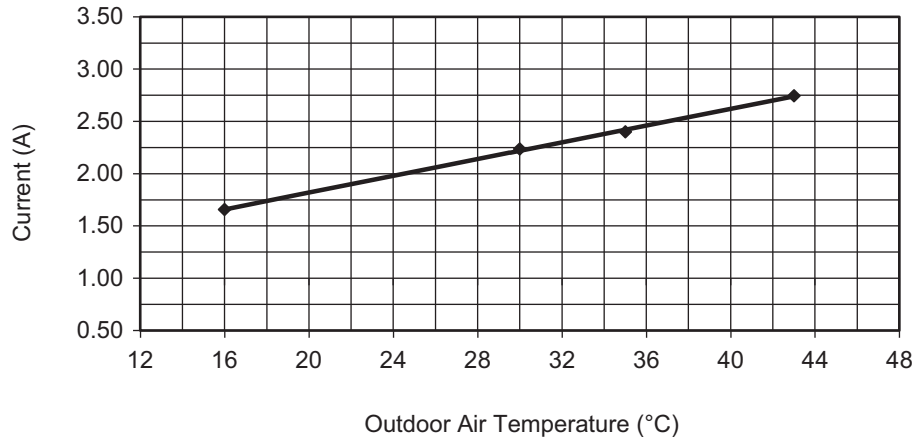
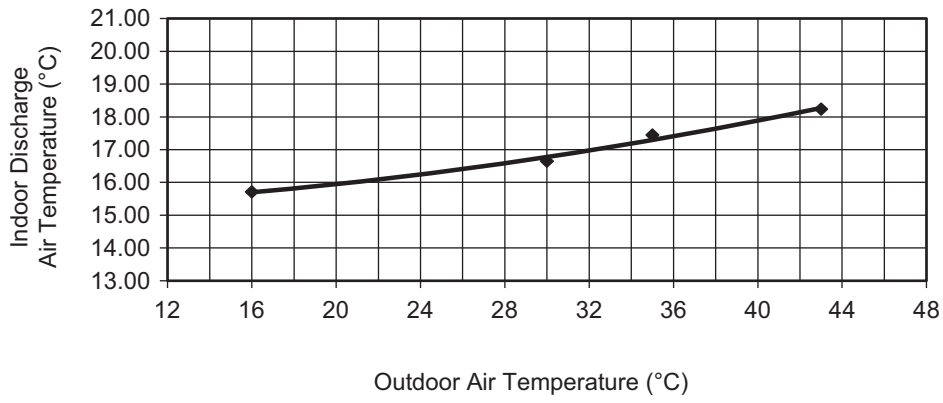

21.1.3 CS-Z35XKEW CU-Z35XKE CS-XZ35XKEW CU-Z35XKE

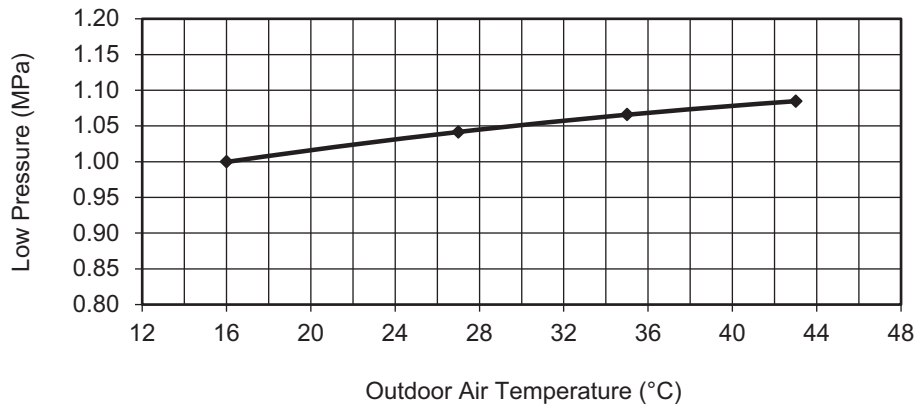
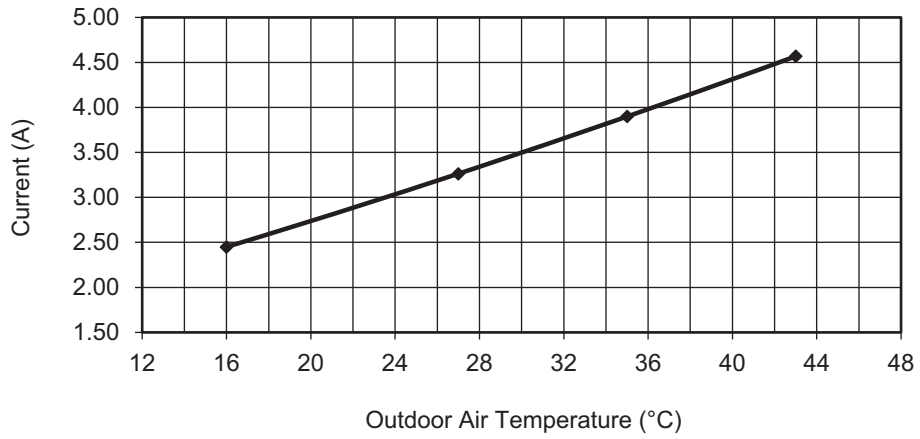
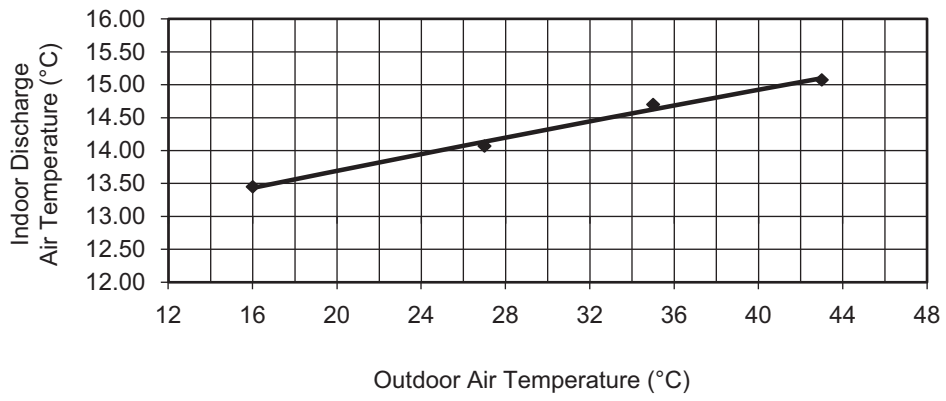

21.1.4 CS-Z42XKEW CU-Z42XKE

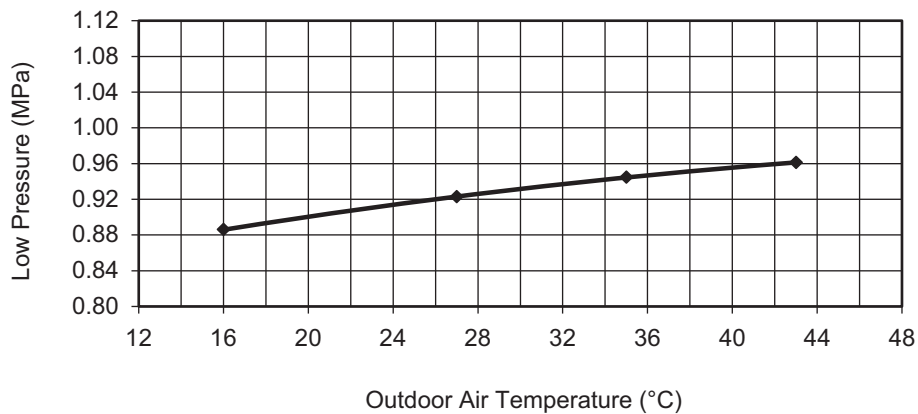
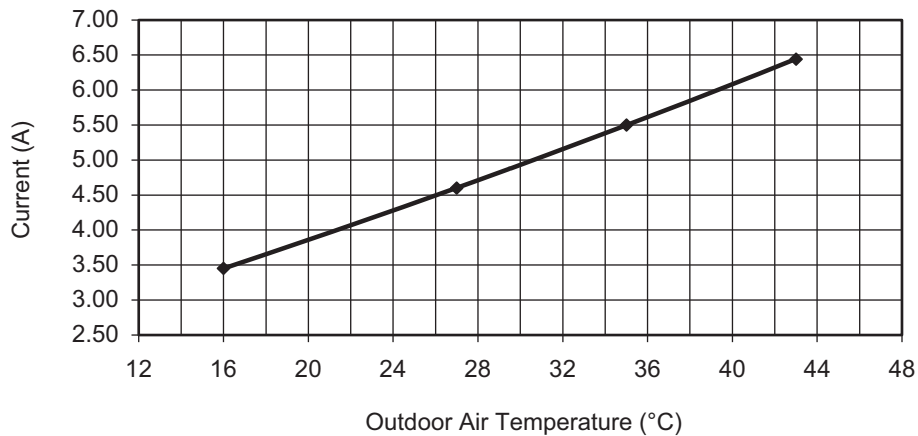
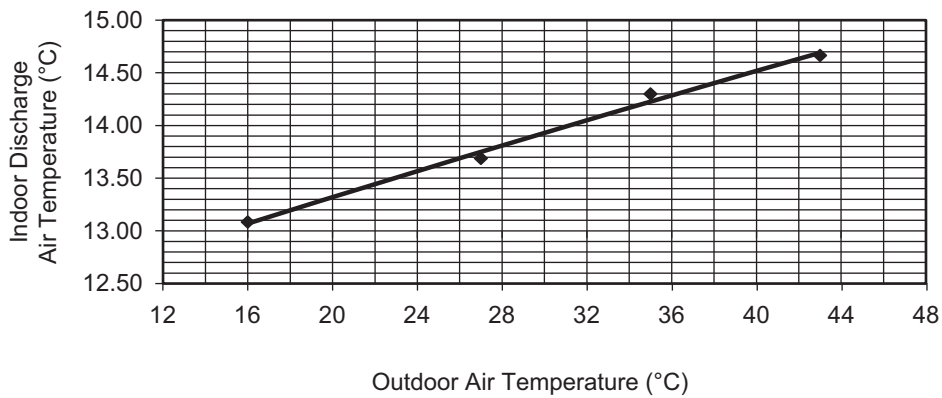

21.1.5 CS-Z50XKEW CU-Z50XKE CS-XZ50XKEW CU-Z50XKE

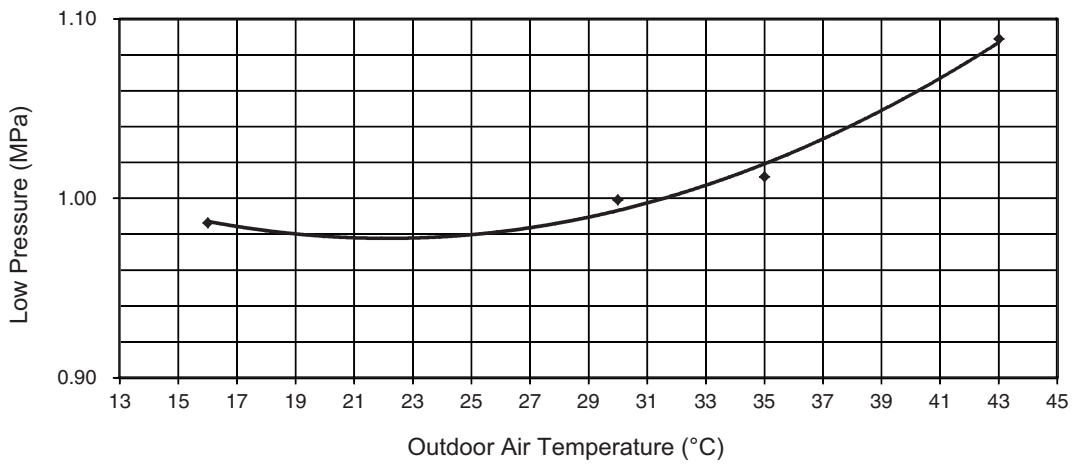
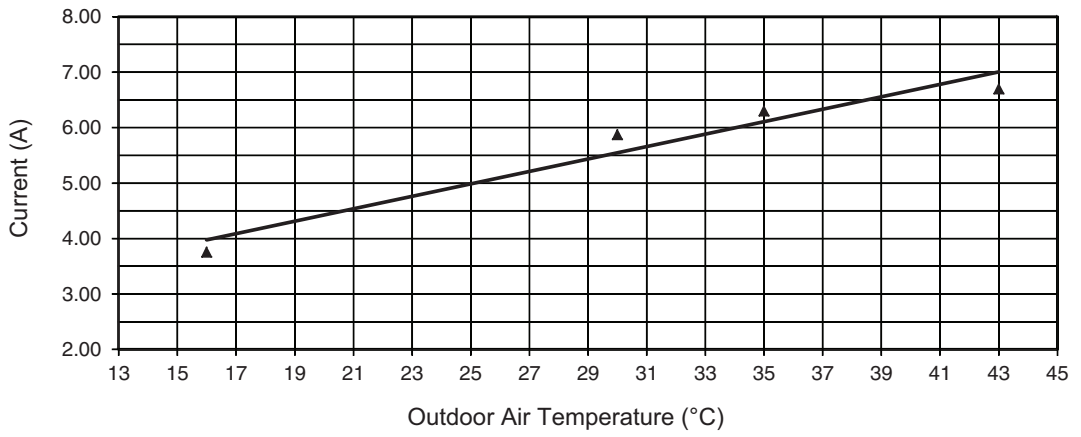
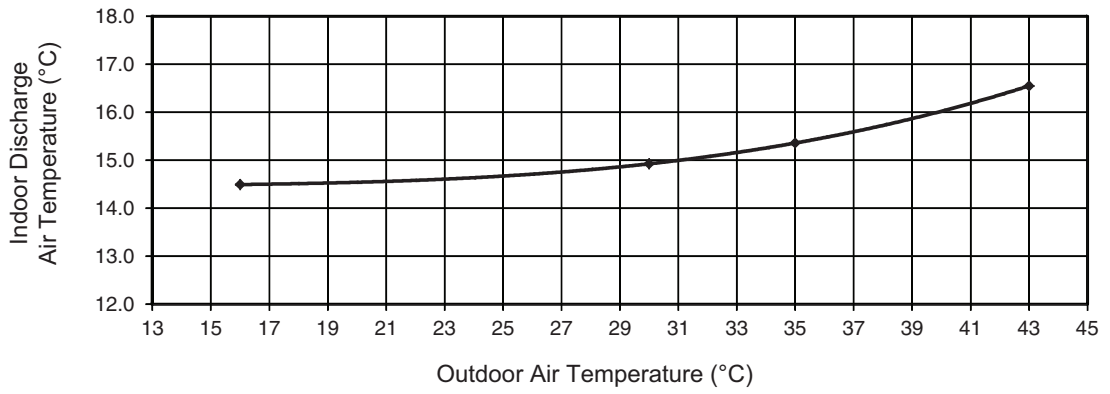

21.1.6 CS-Z71XKEW CU-Z71XKE

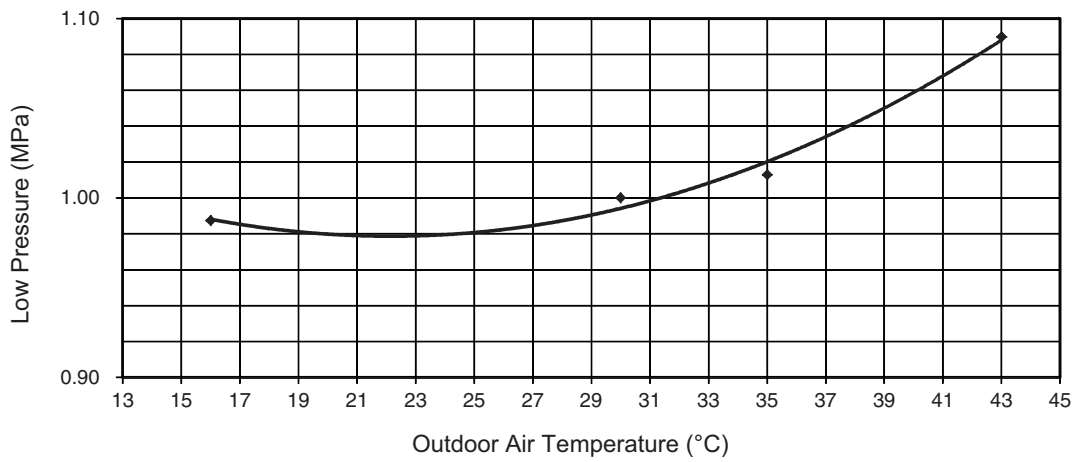
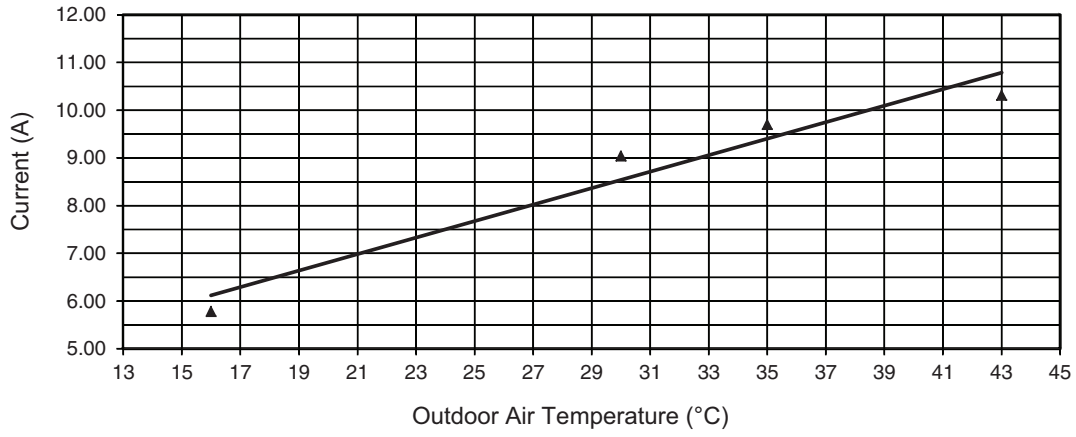
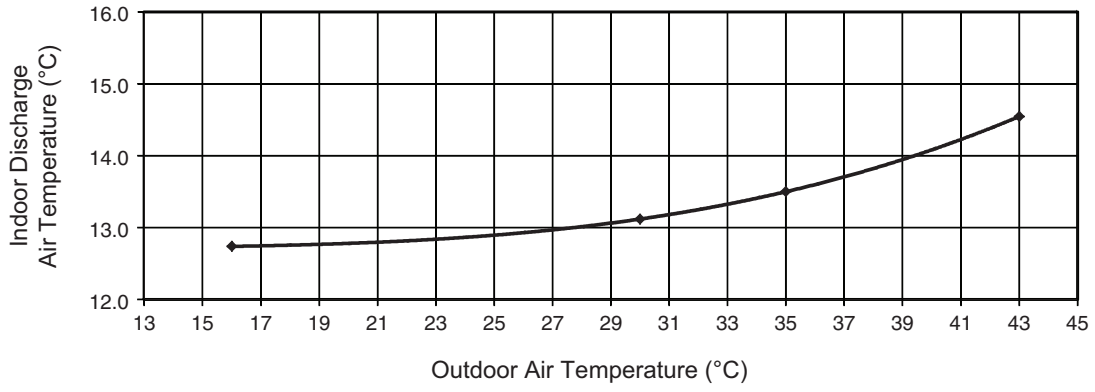

21.2 Heat Mode Outdoor Air Temperature Characteristic

Condition

- Indoor room temperature: 20°C Dry Bulb/ -°C Wet Bulb
- Unit setting: Standard piping length, forced heating at 30°C, Hi fan
- Compressor frequency: Rated for Heating operation
- Piping length: 5m
- Voltage: 230V

21.2.1 CS-Z20XKEW CU-Z20XKE CS-XZ20XKEW CU-Z20XKE

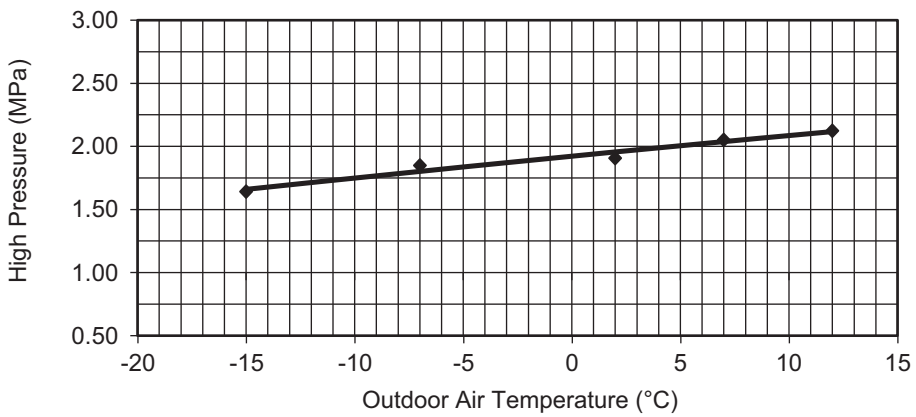
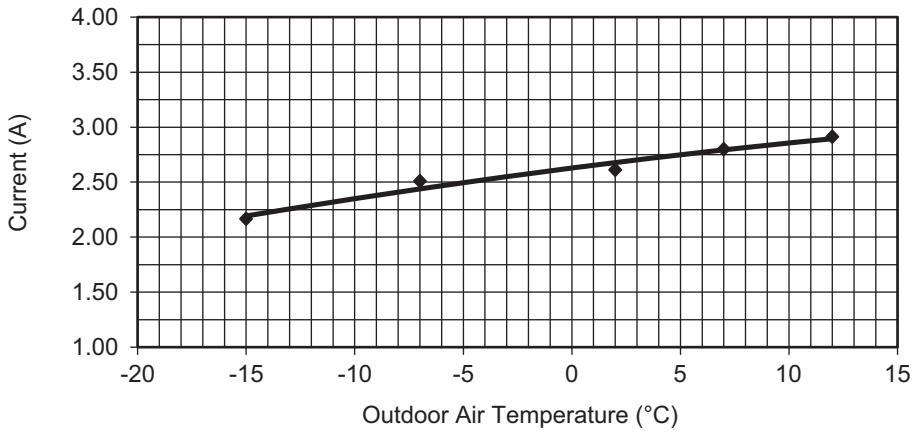
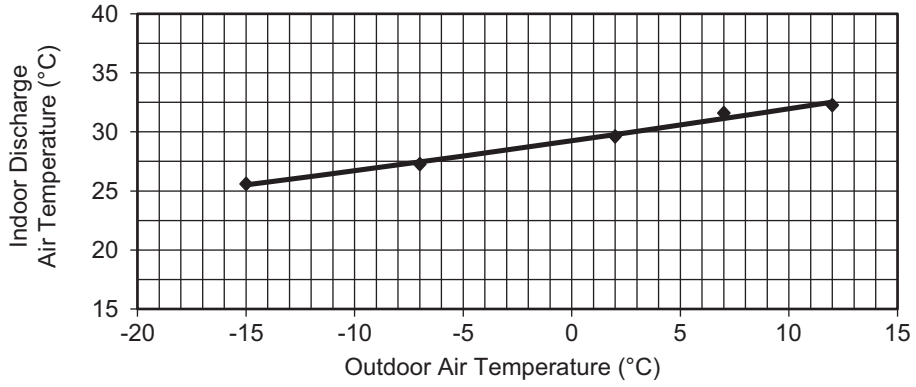

21.2.2 CS-Z25XKEW CU-Z25XKE CS-XZ25XKEW CU-Z25XKE

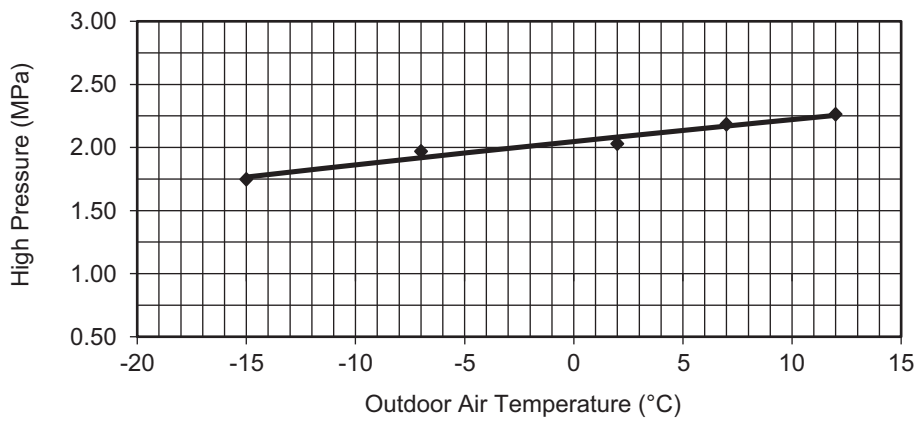
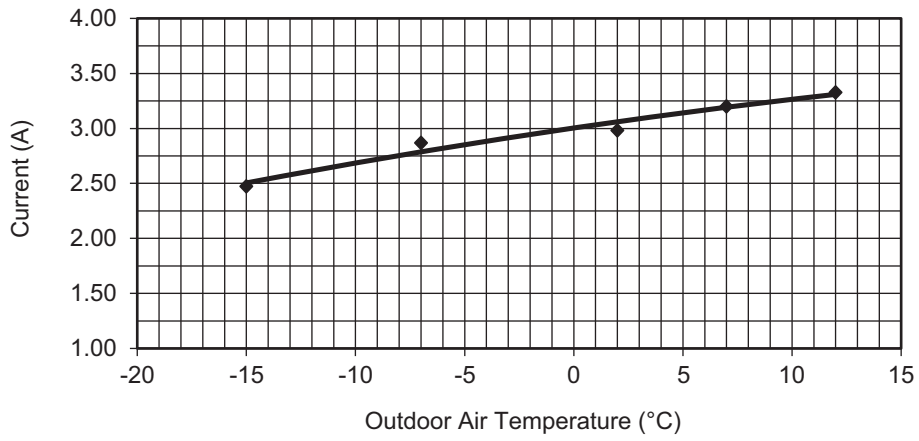
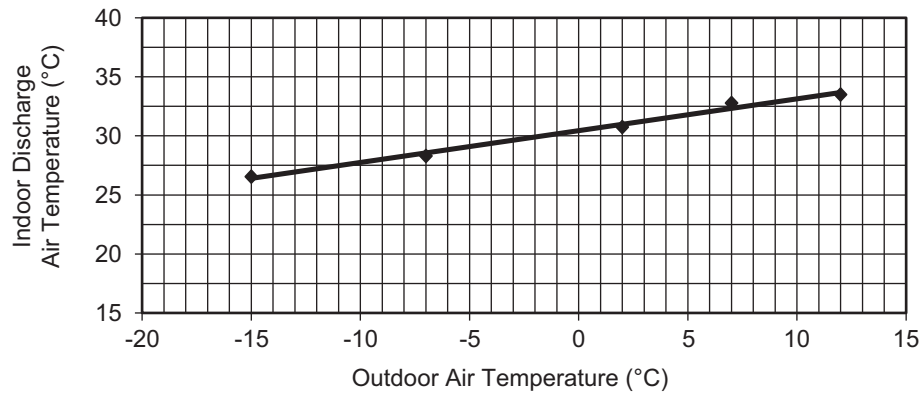

21.2.3 CS-Z35XKEW CU-Z35XKE CS-XZ35XKEW CU-Z35XKE

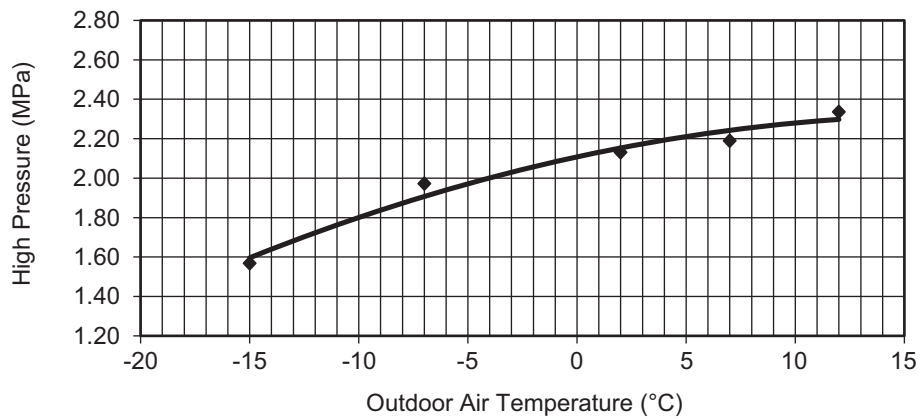
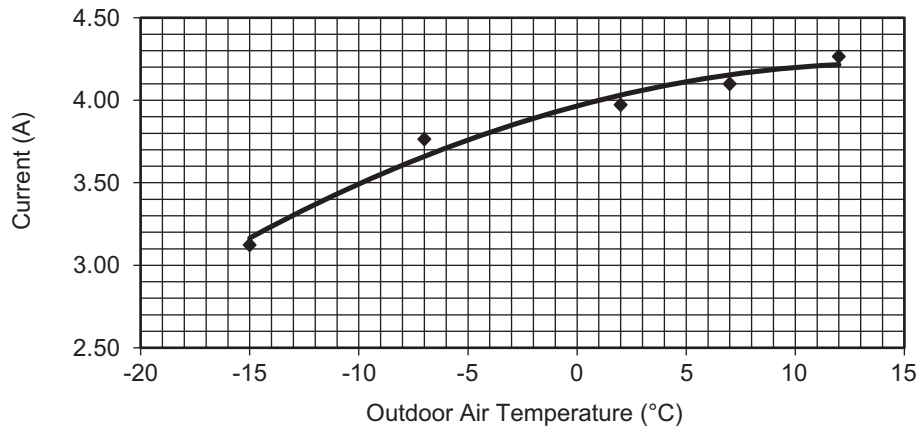
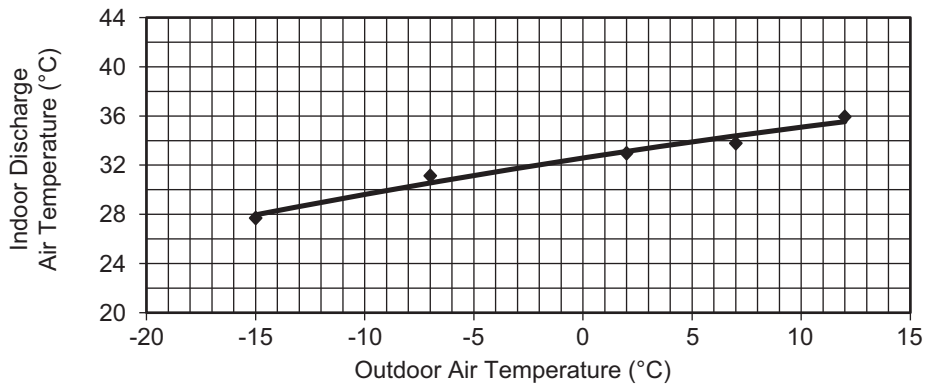

21.2.4 CS-Z42XKEW CU-Z42XKE

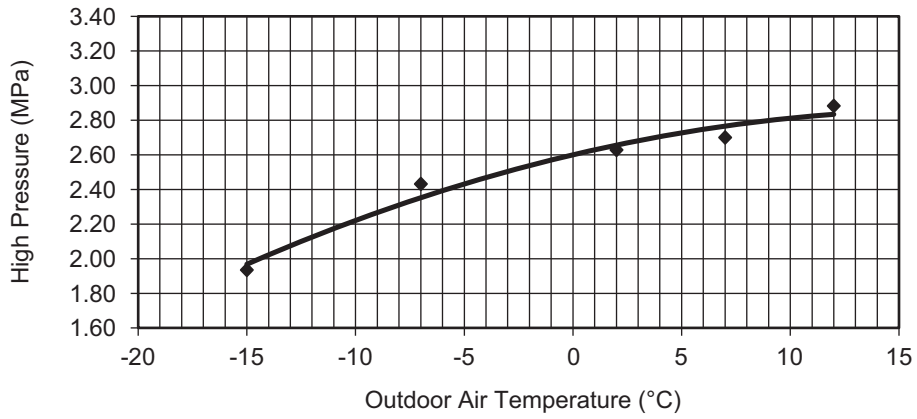
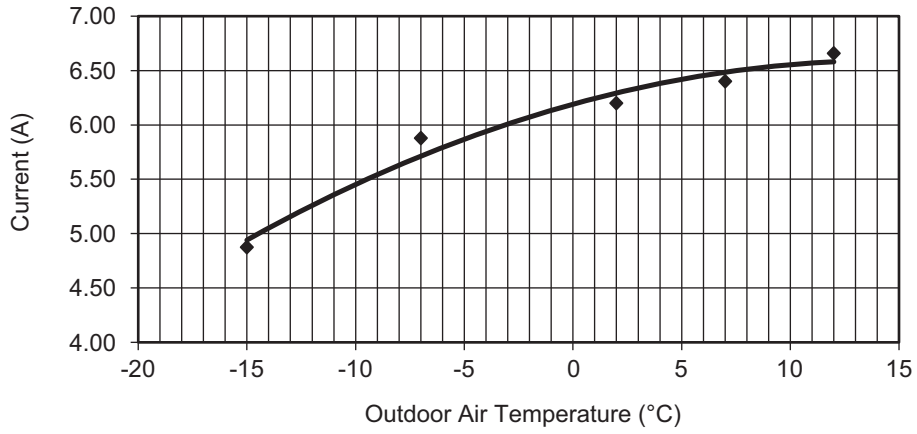
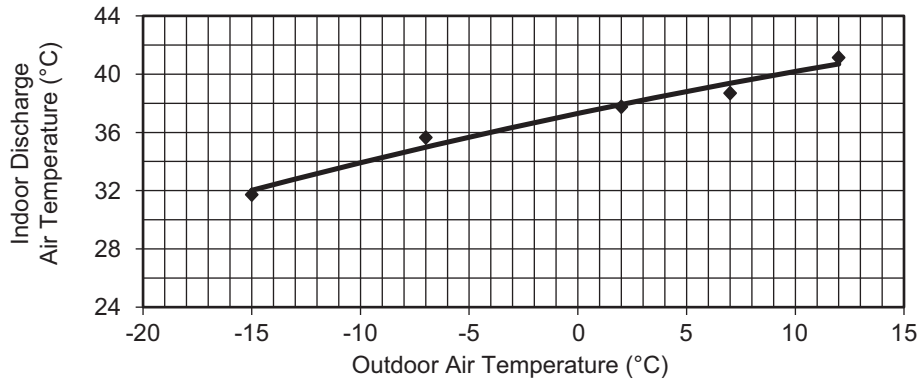

21.2.5 CS-Z50XKEW CU-Z50XKE CS-XZ50XKEW CU-Z50XKE

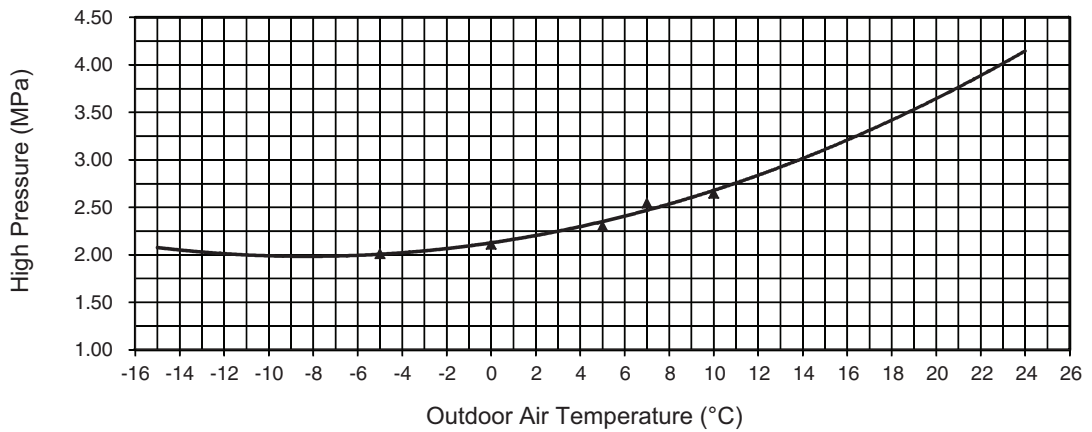
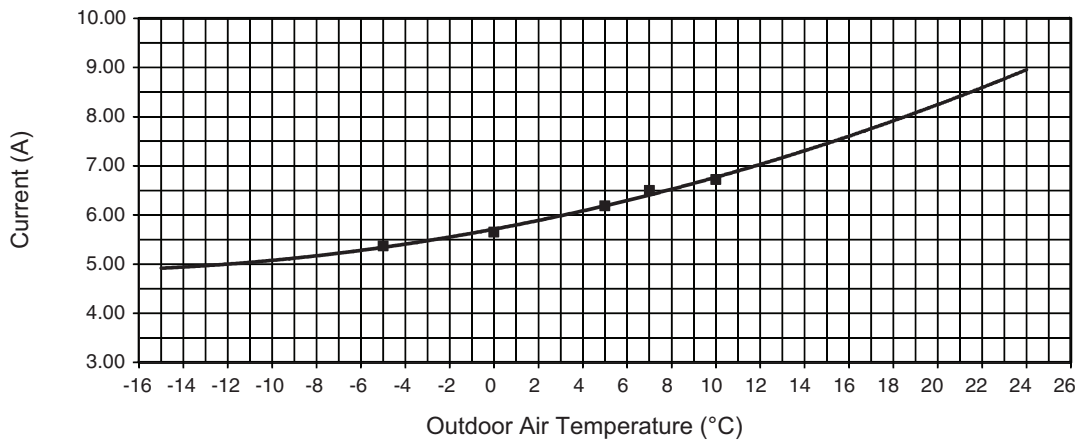
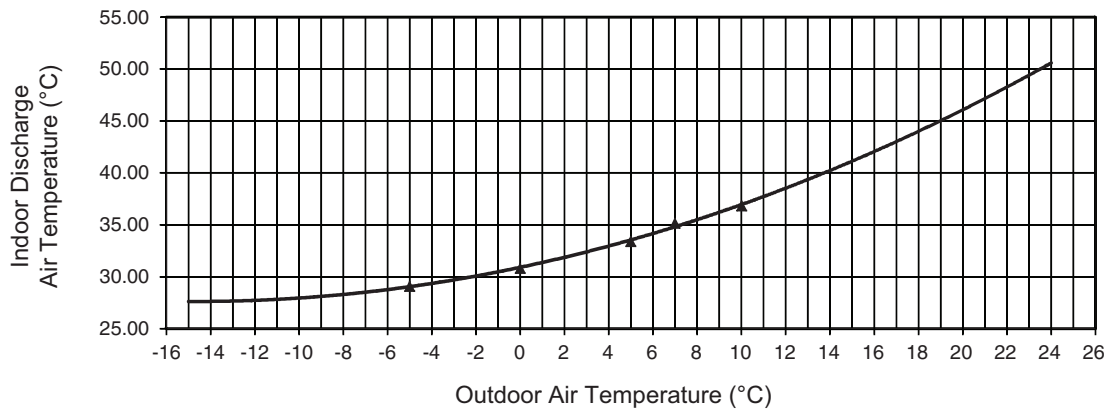

21.2.6 CS-Z71XKEW CU-Z71XKE

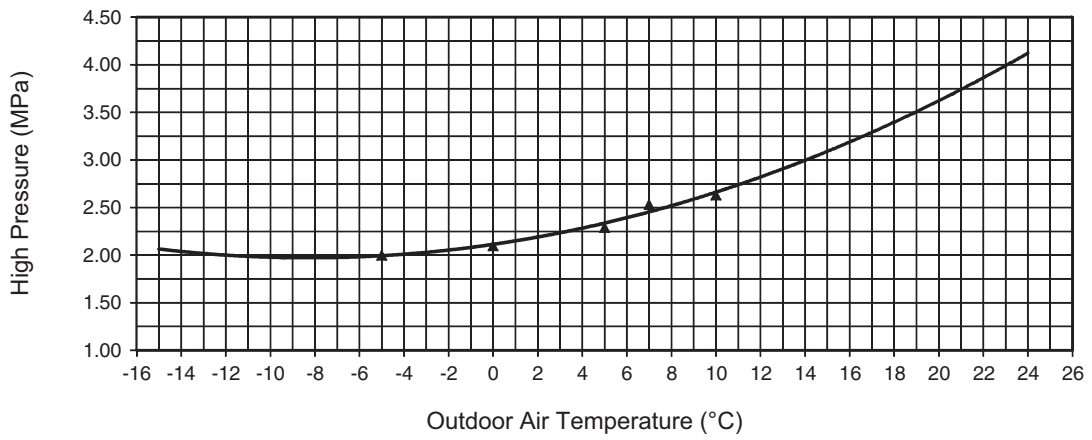
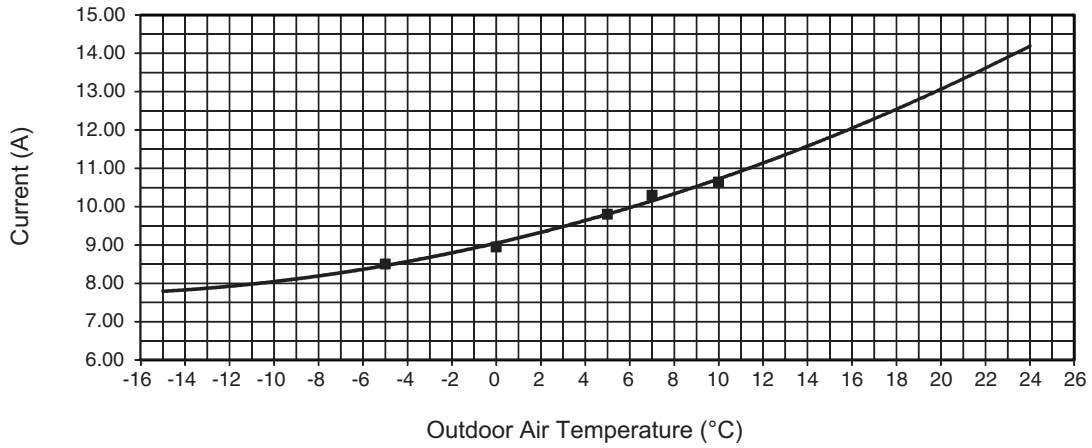
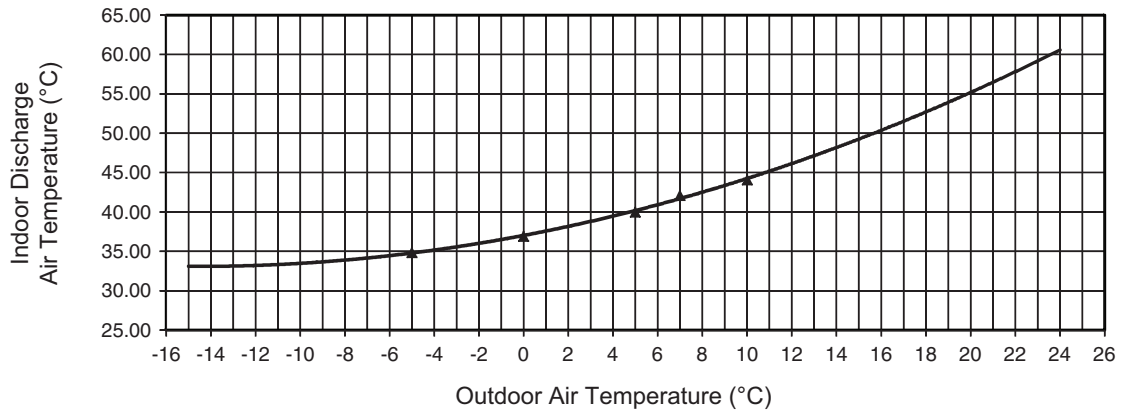

21.3 Piping Length Correction Factor

The characteristic of the unit has to be corrected in accordance with the piping length.

21.3.1 CS-Z20XKEW CU-Z20XKE CS-Z25XKEW CU-Z25XKE CS-Z35XKEW CU-Z35XKE CS-Z42XKEW CU-Z42XKE CS-XZ20XKEW CU-Z20XKE CS-XZ25XKEW CU-Z25XKE CS-XZ35XKEW CU-Z35XKE

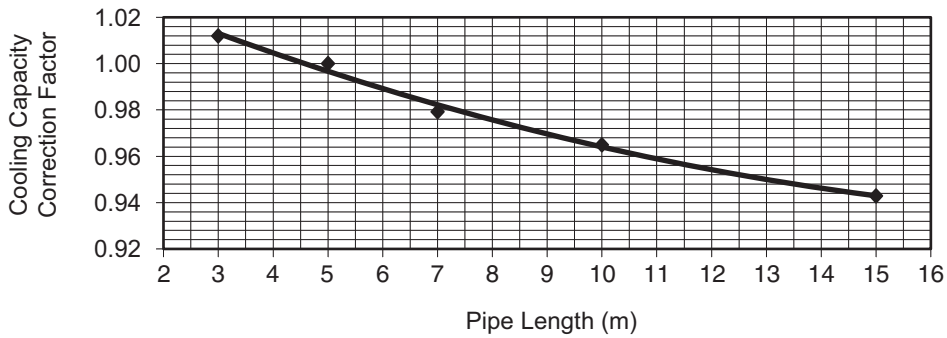

Cooling Capacity

3	1.0119
5	1.0000
7	0.9792
10	0.9650
15	0.9429

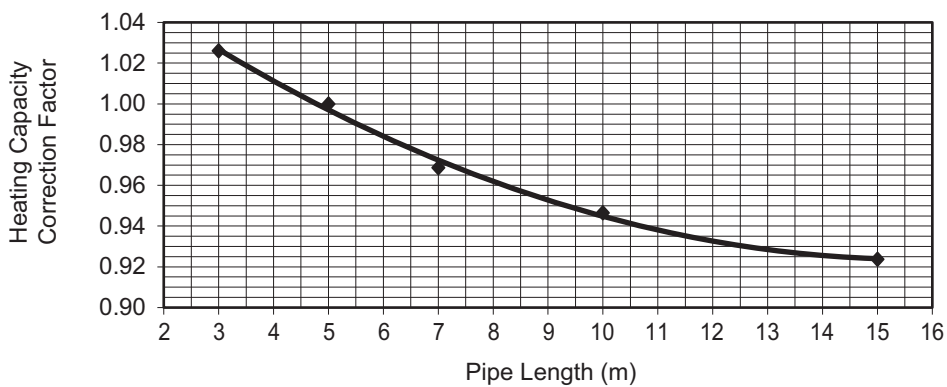

Heating Capacity

3	1.0261
5	1.0000
7	0.9687
10	0.9465
15	0.9237

Note: The graphs show the factor after added right amount of additional refrigerant.

21.3.2 CS-Z50XKEW CU-Z50XKE CS-Z71XKEW CU-Z71XKE CS-XZ50XKEW CU-Z50XKE

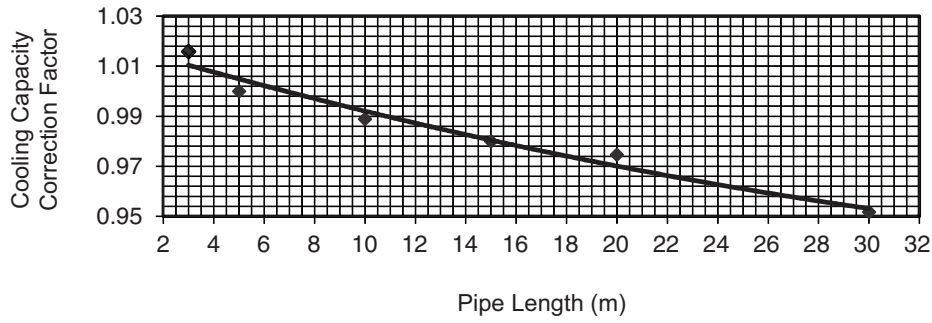

3	1.0159
5	1.0000
10	0.9889
15	0.9800
20	0.9746
30	0.951634

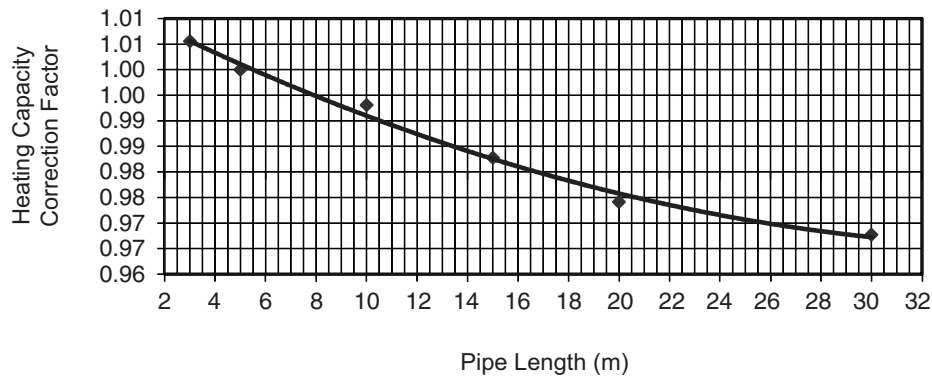

3	1.0056
5	1.0000
10	0.9931
15	0.9828
20	0.9741
30	0.9677

Note: The graphs show the factor after added right amount of additional refrigerant.
 Maximum piping length for Z50XKEW is 20 meters.
 Maximum piping length for Z71XKEW is 30 meters.

22. Exploded View and Replacement Parts List

22.1 Indoor Unit

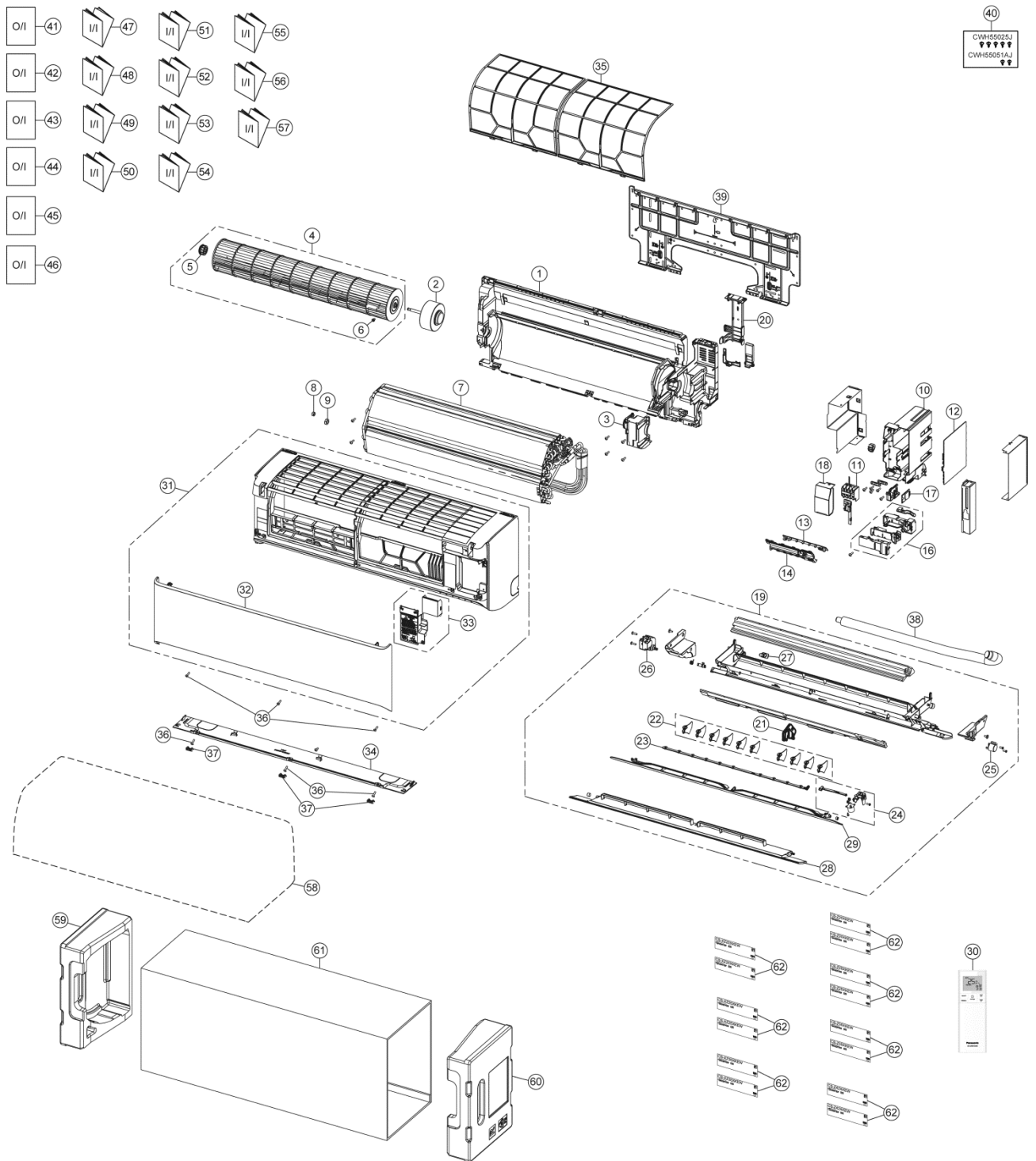

Note

The above exploded view is for the purpose of parts disassembly and replacement.
 The non-numbered parts are not kept as standard service parts.

SAFETY	REF. NO.	PART NAME & DESCRIPTION	QTY.	CS-Z20XKEW	CS-Z25XKEW	REMARK
	1	CHASSIS COMPLETE	1	ACXD50C04160	←	
⚠	2	FAN MOTOR	1	L6CBYYYYL0306	←	O
	3	FAN MOTOR BRACKET	1	ACXD54-04360	←	
	4	CROSS-FLOW FAN COMPLETE	1	ACXH02C01330	←	
	5	BEARING ASSY	1	CWH64K1010	←	
	6	SCREW - CROSS-FLOW FAN	1	CWH551146	←	
	7	EVAPORATOR	1	ACXB30C32540	←	
	8	FLARE NUT (LIQUID)	1	CWT251048	←	
	9	FLARE NUT (GAS)	1	CWT251049	←	
	10	CONTROL BOARD CASING	1	ACXH10-08620	←	
⚠	11	TERMINAL BOARD COMPLETE	1	ACXA28C05900	←	O
⚠	12	ELECTRONIC CONTROLLER - MAIN	1	ACXA73C72460	ACXA73C72470	O
⚠	13	ELECTRONIC CONTROLLER-INDICATOR	1	ACXA73-37110	←	O
	14	INDICATOR HOLDER	1	ACXD93-22430	←	
⚠	15	SENSOR COMPLETE	1	CWA50C2663	←	O
⚠	16	GENERATOR COMPLETE	1	ACXH94C01420	←	O
⚠	17	ELECTRONIC CONTROLLER-WIFI	1	ACXA73-28520	←	O
	18	CONTROL BOARD TOP COVER	1	ACXH13-08680	←	
	19	DISCHARGE GRILLE COMPLETE	1	ACXE20C06080	←	
	20	BACK COVER CHASSIS	1	ACXD93-22420	←	
	21	FULCRUM	1	ACXH62-00790	←	
	22	VERTICAL VANE	10	ACXE24-04000	←	
	23	CONNECTING BAR	1	ACXE26-02550	←	
⚠	24	AIR SWING MOTOR ASSY	1	ACXA98K00220	←	O
⚠	25	AIR SWING MOTOR	1	ACXA98-02420	←	O
⚠	26	GEAR-COMPLETE	1	ACXH68C00520	←	O
	27	CAP - DRAIN TRAY	1	CWH521096	←	
	28	HORIZONTAL VANE COMPLETE - BIG	1	ACXE24C04660	←	
	29	HORIZONTAL VANE COMPLETE	1	ACXE24C04670	←	
⚠	30	REMOTE CONTROL COMPLETE	1	ACXA75C20670	←	O
	31	FRONT GRILLE COMPLETE	1	ACXE10C13460	←	
	32	INTAKE GRILLE COMPLETE	1	ACXE22K09860	←	
	33	GRILLE DOOR COMPLETE	1	ACXE14C01440	←	
	34	PARTICULAR PLATE	1	ACXD90-26390	←	
	35	AIR FILTER	2	ACXD00-02990	←	
	36	SCREW - FRONT GRILLE	6	XTT4+16CFJ	←	
	37	CAP - FRONT GRILLE	3	ACXH52-04000	←	
	38	DRAIN HOSE	1	ACXH85-00210	←	
	39	INSTALLATION PLATE	1	ACXH36-00840	←	
	40	BAG COMPLETE - INSTALLATION SCREW	1	CWH82C1705	←	
	41	OPERATING INSTRUCTION	1	ACXF55-29741	←	
	42	OPERATING INSTRUCTION	1	ACXF55-29751	←	
	43	OPERATING INSTRUCTION	1	ACXF55-29761	←	
	44	OPERATING INSTRUCTION	1	ACXF55-30281	←	
	45	OPERATING INSTRUCTION	1	ACXF55-30291	←	
	46	OPERATING INSTRUCTION	1	ACXF55-30301	←	
	47	INSTALLATION INSTRUCTION	1	ACXF60-42501	←	

SAFETY	REF. NO.	PART NAME & DESCRIPTION	QTY.	CS-Z20XKEW	CS-Z25XKEW	REMARK
	48	INSTALLATION INSTRUCTION	1	ACXF60-42511	←	
	49	INSTALLATION INSTRUCTION	1	ACXF60-42521	←	
	50	INSTALLATION INSTRUCTION	1	ACXF60-42531	←	
	51	INSTALLATION INSTRUCTION	1	ACXF60-42541	←	
	52	INSTALLATION INSTRUCTION	1	ACXF60-42551	←	
	53	INSTALLATION INSTRUCTION	1	ACXF60-42561	←	
	54	INSTALLATION INSTRUCTION	1	ACXF60-42571	←	
	55	INSTALLATION INSTRUCTION	1	ACXF60-42581	←	
	56	INSTALLATION INSTRUCTION	1	ACXF60-42591	←	
	57	INSTALLATION INSTRUCTION	1	ACXF60-42601	←	
	58	BAG	1	CWG861497	←	
	59	SHOCK ABSORBER- LEFT	1	ACXG70-12960	←	
	60	SHOCK ABSORBER - RIGHT	1	ACXG70-12970	←	
	61	C.C.CASE	1	ACXG50-57100	←	
	62	MODEL LABEL	2	ACXF85-62730	ACXF85-62740	

(NOTE)

- All parts are supplied from PAPAMY, Malaysia (Vendor Code: 00029488).
- "O" marked parts are recommended to be kept in stock.

SAFETY	REF. NO.	PART NAME & DESCRIPTION	QTY.	CS-Z35XKEW	CS-Z42XKEW	REMARK
	1	CHASSIS COMPLETE	1	ACXD50C04160	←	
⚠	2	FAN MOTOR	1	L6CBYYYL0306	←	O
	3	FAN MOTOR BRACKET	1	ACXD54-04360	←	
	4	CROSS-FLOW FAN COMPLETE	1	ACXH02C01330	←	
	5	BEARING ASSY	1	CWH64K1010	←	
	6	SCREW - CROSS-FLOW FAN	1	CWH551146	←	
	7	EVAPORATOR	1	ACXB30C32570	ACXB30C32550	
	8	FLARE NUT (LIQUID)	1	CWT251048	←	
	9	FLARE NUT (GAS)	1	CWT251049	CWT251032	
	10	CONTROL BOARD CASING	1	ACXH10-08620	←	
⚠	11	TERMINAL BOARD COMPLETE	1	ACXA28C05900	←	O
⚠	12	ELECTRONIC CONTROLLER - MAIN	1	ACXA73C72480	ACXA73C72490	O
⚠	13	ELECTRONIC CONTROLLER-INDICATOR	1	ACXA73-37110	←	O
	14	INDICATOR HOLDER	1	ACXD93-22430	←	
⚠	15	SENSOR COMPLETE	1	CWA50C3226	CWA50C2663	O
⚠	16	GENERATOR COMPLETE	1	ACXH94C01420	←	O
⚠	17	ELECTRONIC CONTROLLER-WIFI	1	ACXA73-28520	←	O
	18	CONTROL BOARD TOP COVER	1	ACXH13-08680	←	
	19	DISCHARGE GRILLE COMPLETE	1	ACXE20C06080	←	
	20	BACK COVER CHASSIS	1	ACXD93-22420	←	
	21	FULCRUM	1	ACXH62-00790	←	
	22	VERTICAL VANE	10	ACXE24-04000	←	
	23	CONNECTING BAR	1	ACXE26-02550	←	
⚠	24	AIR SWING MOTOR ASSY	1	ACXA98K00220	←	O
⚠	25	AIR SWING MOTOR	1	ACXA98-02420	←	O
⚠	26	GEAR-COMPLETE	1	ACXH68C00520	←	O
	27	CAP - DRAIN TRAY	1	CWH521096	←	
	28	HORIZONTAL VANE COMPLETE - BIG	1	ACXE24C04660	←	
	29	HORIZONTAL VANE COMPLETE	1	ACXE24C04670	←	
⚠	30	REMOTE CONTROL COMPLETE	1	ACXA75C20670	←	O
	31	FRONT GRILLE COMPLETE	1	ACXE10C13470	ACXE10C13460	
	32	INTAKE GRILLE COMPLETE	1	ACXE22K09860	←	
	33	GRILLE DOOR COMPLETE	1	ACXE14C01440	←	
	34	PARTICULAR PLATE	1	ACXD90-26390	←	
	35	AIR FILTER	2	ACXD00-02990	←	
	36	SCREW - FRONT GRILLE	6	XTT4+16CFJ	←	
	37	CAP - FRONT GRILLE	3	ACXH52-04000	←	
	38	DRAIN HOSE	1	ACXH85-00140	ACXH85-00210	
	39	INSTALLATION PLATE	1	ACXH36-00840	←	
	40	BAG COMPLETE - INSTALLATION SCREW	1	CWH82C1705	←	
	41	OPERATING INSTRUCTION	1	ACXF55-29741	←	
	42	OPERATING INSTRUCTION	1	ACXF55-29751	←	
	43	OPERATING INSTRUCTION	1	ACXF55-29761	←	
	44	OPERATING INSTRUCTION	1	ACXF55-30281	←	
	45	OPERATING INSTRUCTION	1	ACXF55-30291	←	
	46	OPERATING INSTRUCTION	1	ACXF55-30301	←	
	47	INSTALLATION INSTRUCTION	1	ACXF60-42501	←	

SAFETY	REF. NO.	PART NAME & DESCRIPTION	QTY.	CS-Z35XKEW	CS-Z42XKEW	REMARK
	48	INSTALLATION INSTRUCTION	1	ACXF60-42511	←	
	49	INSTALLATION INSTRUCTION	1	ACXF60-42521	←	
	50	INSTALLATION INSTRUCTION	1	ACXF60-42531	←	
	51	INSTALLATION INSTRUCTION	1	ACXF60-42541	←	
	52	INSTALLATION INSTRUCTION	1	ACXF60-42551	←	
	53	INSTALLATION INSTRUCTION	1	ACXF60-42561	←	
	54	INSTALLATION INSTRUCTION	1	ACXF60-42571	←	
	55	INSTALLATION INSTRUCTION	1	ACXF60-42581	←	
	56	INSTALLATION INSTRUCTION	1	ACXF60-42591	←	
	57	INSTALLATION INSTRUCTION	1	ACXF60-42601	←	
	58	BAG	1	CWG861497	←	
	59	SHOCK ABSORBER- LEFT	1	ACXG70-12960	←	
	60	SHOCK ABSORBER - RIGHT	1	ACXG70-12970	←	
	61	C.C.CASE	1	ACXG50-57100	←	
	62	MODEL LABEL	2	ACXF85-62750	ACXF85-62760	

(NOTE)

- All parts are supplied from PAPAMY, Malaysia (Vendor Code: 00029488).
- "O" marked parts are recommended to be kept in stock.

SAFETY	REF. NO.	PART NAME & DESCRIPTION	QTY.	CS-XZ20XKEW	CS-XZ25XKEW	REMARK
	1	CHASSIS COMPLETE	1	ACXD50C04190	←	
⚠	2	FAN MOTOR	1	L6CBYYYL0306	←	O
	3	FAN MOTOR BRACKET	1	ACXD54-04360	←	
	4	CROSS-FLOW FAN COMPLETE	1	ACXH02C01330	←	
	5	BEARING ASSY	1	CWH64K1010	←	
	6	SCREW - CROSS-FLOW FAN	1	CWH551146	←	
	7	EVAPORATOR	1	ACXB30C32540	←	
	8	FLARE NUT (LIQUID)	1	CWT251048	←	
	9	FLARE NUT (GAS)	1	CWT251049	←	
	10	CONTROL BOARD CASING	1	ACXH10-08620	←	
⚠	11	TERMINAL BOARD COMPLETE	1	ACXA28C05900	←	O
⚠	12	ELECTRONIC CONTROLLER - MAIN	1	ACXA73C72460	ACXA73C72470	O
⚠	13	ELECTRONIC CONTROLLER-INDICATOR	1	ACXA73-37110	←	O
	14	INDICATOR HOLDER	1	ACXD93-22430	←	
⚠	15	SENSOR COMPLETE	1	CWA50C2663	←	O
⚠	16	GENERATOR COMPLETE	1	ACXH94C01420	←	O
⚠	17	ELECTRONIC CONTROLLER-WIFI	1	ACXA73-28520	←	O
	18	CONTROL BOARD TOP COVER	1	ACXH13-08680	←	
	19	DISCHARGE GRILLE COMPLETE	1	ACXE20C06520	←	
	20	BACK COVER CHASSIS	1	ACXD93-22420	←	
	21	FULCRUM	1	ACXH62-00790	←	
	22	VERTICAL VANE	10	ACXE24-04000	←	
	23	CONNECTING BAR	1	ACXE26-02550	←	
⚠	24	AIR SWING MOTOR ASSY	1	ACXA98K00220	←	O
⚠	25	AIR SWING MOTOR	1	ACXA98-02420	←	O
⚠	26	GEAR-COMPLETE	1	ACXH68C00520	←	O
	27	CAP - DRAIN TRAY	1	CWH521259	←	
	28	HORIZONTAL VANE COMPLETE - BIG	1	ACXE24C04960	←	
	29	HORIZONTAL VANE COMPLETE	1	ACXE24C04970	←	
⚠	30	REMOTE CONTROL COMPLETE	1	ACXA75C20670	←	O
	31	FRONT GRILLE COMPLETE	1	ACXE10C13510	←	
	32	INTAKE GRILLE COMPLETE	1	ACXE22K09880	←	
	33	GRILLE DOOR COMPLETE	1	ACXE14C01430	←	
	34	PARTICULAR PLATE	1	ACXD90K02220	←	
	35	AIR FILTER	2	ACXD00-02990	←	
	36	SCREW - FRONT GRILLE	6	XTT4+16CFJ	←	
	37	CAP - FRONT GRILLE	3	ACXH52-04000A	←	
	38	DRAIN HOSE	1	ACXH85-00210	←	
	39	INSTALLATION PLATE	1	ACXH36-00840	←	
	40	BAG COMPLETE - INSTALLATION SCREW	1	CWH82C1705	←	
	41	OPERATING INSTRUCTION	1	ACXF55-29741	←	
	42	OPERATING INSTRUCTION	1	ACXF55-29751	←	
	43	OPERATING INSTRUCTION	1	ACXF55-29761	←	
	44	OPERATING INSTRUCTION	1	ACXF55-30281	←	
	45	OPERATING INSTRUCTION	1	ACXF55-30291	←	
	46	OPERATING INSTRUCTION	1	ACXF55-30301	←	
	47	INSTALLATION INSTRUCTION	1	ACXF60-42501	←	

SAFETY	REF. NO.	PART NAME & DESCRIPTION	QTY.	CS-XZ20XKEW	CS-XZ25XKEW	REMARK
	48	INSTALLATION INSTRUCTION	1	ACXF60-42511	←	
	49	INSTALLATION INSTRUCTION	1	ACXF60-42521	←	
	50	INSTALLATION INSTRUCTION	1	ACXF60-42531	←	
	51	INSTALLATION INSTRUCTION	1	ACXF60-42541	←	
	52	INSTALLATION INSTRUCTION	1	ACXF60-42551	←	
	53	INSTALLATION INSTRUCTION	1	ACXF60-42561	←	
	54	INSTALLATION INSTRUCTION	1	ACXF60-42571	←	
	55	INSTALLATION INSTRUCTION	1	ACXF60-42581	←	
	56	INSTALLATION INSTRUCTION	1	ACXF60-42591	←	
	57	INSTALLATION INSTRUCTION	1	ACXF60-42601	←	
	58	BAG	1	CWG861497	←	
	59	SHOCK ABSORBER- LEFT	1	ACXG70-12960	←	
	60	SHOCK ABSORBER - RIGHT	1	ACXG70-12970	←	
	61	C.C.CASE	1	ACXG50-57100	←	
	62	MODEL LABEL	2	ACXF85-63940	ACXF85-63950	

(NOTE)

- All parts are supplied from PAPAMY, Malaysia (Vendor Code: 00029488).
- "O" marked parts are recommended to be kept in stock.

SAFETY	REF. NO.	PART NAME & DESCRIPTION	QTY.	CS-XZ35XKEW	REMARK
	1	CHASSIS COMPLETE	1	ACXD50C04190	
⚠	2	FAN MOTOR	1	L6CBYYL0306	O
	3	FAN MOTOR BRACKET	1	ACXD54-04360	
	4	CROSS-FLOW FAN COMPLETE	1	ACXH02C01330	
	5	BEARING ASSY	1	CWH64K1010	
	6	SCREW - CROSS-FLOW FAN	1	CWH551146	
	7	EVAPORATOR	1	ACXB30C32570	
	8	FLARE NUT (LIQUID)	1	CWT251048	
	9	FLARE NUT (GAS)	1	CWT251049	
	10	CONTROL BOARD CASING	1	ACXH10-08620	
⚠	11	TERMINAL BOARD COMPLETE	1	ACXA28C05900	O
⚠	12	ELECTRONIC CONTROLLER - MAIN	1	ACXA73C72480	O
⚠	13	ELECTRONIC CONTROLLER-INDICATOR	1	ACXA73-37110	O
	14	INDICATOR HOLDER	1	ACXD93-22430	
⚠	15	SENSOR COMPLETE	1	CWA50C3226	O
⚠	16	GENERATOR COMPLETE	1	ACXH94C01420	O
⚠	17	ELECTRONIC CONTROLLER-WIFI	1	ACXA73-28520	O
	18	CONTROL BOARD TOP COVER	1	ACXH13-08680	
	19	DISCHARGE GRILLE COMPLETE	1	ACXE20C06520	
	20	BACK COVER CHASSIS	1	ACXD93-22420	
	21	FULCRUM	1	ACXH62-00790	
	22	VERTICAL VANE	10	ACXE24-04000	
	23	CONNECTING BAR	1	ACXE26-02550	
⚠	24	AIR SWING MOTOR ASSY	1	ACXA98K00220	O
⚠	25	AIR SWING MOTOR	1	ACXA98-02420	O
⚠	26	GEAR-COMPLETE	1	ACXH68C00520	O
	27	CAP - DRAIN TRAY	1	CWH521259	
	28	HORIZONTAL VANE COMPLETE - BIG	1	ACXE24C04960	
	29	HORIZONTAL VANE COMPLETE	1	ACXE24C04970	
⚠	30	REMOTE CONTROL COMPLETE	1	ACXA75C20670	O
	31	FRONT GRILLE COMPLETE	1	ACXE10C13520	
	32	INTAKE GRILLE COMPLETE	1	ACXE22K09880	
	33	GRILLE DOOR COMPLETE	1	ACXE14C01430	
	34	PARTICULAR PLATE	1	ACXD90K02220	
	35	AIR FILTER	2	ACXD00-02990	
	36	SCREW - FRONT GRILLE	6	XTT4+16CFJ	
	37	CAP - FRONT GRILLE	3	ACXH52-04000A	
	38	DRAIN HOSE	1	ACXH85-00210	
	39	INSTALLATION PLATE	1	ACXH36-00840	
	40	BAG COMPLETE - INSTALLATION SCREW	1	CWH82C1705	
	41	OPERATING INSTRUCTION	1	ACXF55-29741	
	42	OPERATING INSTRUCTION	1	ACXF55-29751	
	43	OPERATING INSTRUCTION	1	ACXF55-29761	
	44	OPERATING INSTRUCTION	1	ACXF55-30281	
	45	OPERATING INSTRUCTION	1	ACXF55-30291	
	46	OPERATING INSTRUCTION	1	ACXF55-30301	
	47	INSTALLATION INSTRUCTION	1	ACXF60-42501	

SAFETY	REF. NO.	PART NAME & DESCRIPTION	QTY.	CS-XZ35XKEW	REMARK
	48	INSTALLATION INSTRUCTION	1	ACXF60-42511	
	49	INSTALLATION INSTRUCTION	1	ACXF60-42521	
	50	INSTALLATION INSTRUCTION	1	ACXF60-42531	
	51	INSTALLATION INSTRUCTION	1	ACXF60-42541	
	52	INSTALLATION INSTRUCTION	1	ACXF60-42551	
	53	INSTALLATION INSTRUCTION	1	ACXF60-42561	
	54	INSTALLATION INSTRUCTION	1	ACXF60-42571	
	55	INSTALLATION INSTRUCTION	1	ACXF60-42581	
	56	INSTALLATION INSTRUCTION	1	ACXF60-42591	
	57	INSTALLATION INSTRUCTION	1	ACXF60-42601	
	58	BAG	1	CWG861497	
	59	SHOCK ABSORBER- LEFT	1	ACXG70-12960	
	60	SHOCK ABSORBER - RIGHT	1	ACXG70-12970	
	61	C.C.CASE	1	ACXG50-57100	
	62	MODEL LABEL	2	ACXF85-63960	

(NOTE)

- All parts are supplied from PAPAMY, Malaysia (Vendor Code: 00029488).
- "O" marked parts are recommended to be kept in stock.

SAFETY	REF. NO.	PART NAME & DESCRIPTION	QTY.	CU-Z20XKE	CU-Z25XKE	REMARK
	1	CHASSIS COMPLETE	1	ACXD52K00150	←	
	2	FAN MOTOR BRACKET	1	CWD541157	←	
	3	SCREW - FAN MOTOR BRACKET	2	ACXH55-07140	←	
⚠	4	FAN MOTOR	1	L6CAYYYL0156	←	O
	5	SCREW - FAN MOTOR MOUNT	4	CWH55252J	←	
	6	PROPELLER FAN ASSY	1	CWH03K1100	←	
	7	NUT - PROPELLER FAN	1	CWH56053J	←	
⚠	8	COMPRESSOR	1	9GS075XAA21	←	O
	10	ANTI - VIBRATION BUSHING	3	ACXH50-00140	←	
	11	NUT - COMPRESSOR MOUNT	3	CWH561096	←	
	12	CONDENSER	1	ACXB32C19940	ACXB32C23130	
	14	DISCHARGE MUFFLER	1	CWB121021	←	
	15	HOLDER COUPLING	1	CWH351233	←	
	16	4-WAYS VALVE	1	ACXB00-01290	←	
	17	DISCHARGE MUFFLER (4 W.VALVE)	3	CWB121010	←	
	19	2-WAYS VALVE (LIQUID)	1	ACXB02-03370	ACXB02-03310	
	20	3-WAY VALVE (GAS)	1	ACXB01-04550	←	
	21	TERMINAL COVER	1	CWH171041	←	
⚠	24	V-COIL COMPLETE - 4 WAY VALVE	1	ACXA43C00250	←	O
	25	O-RING	1	ACXB81-06510	←	
⚠	26	V-COIL COMPLETE - EXP.VALVE	1	ACXA43C06110	←	O
	27	SOUND PROOF BOARD	1	CWH151427	CWH151428	
⚠	28	REACTOR	1	G0C752J00004	←	O
	29	SOUND PROOF MATERIAL - TOP	1	CWG302737	←	
	30	SOUND PROOF MATERIAL - BODY	1	ACXG30-11530	←	
⚠	33	SENSOR CO-COMP TEMP	1	ACXA50C17390	←	O
	34	CONTROL BOARD COVER-TOP	1	ACXH13-00450	←	
⚠	35	ELECTRONIC CONTROLLER - MAIN	1	ACXA73C73630R	ACXA73C73640R	O
	36	TERMINAL BOARD ASSY	1	CWA28K1298	←	
	37	CABINET SIDE PLATE CO.	1	ACXE04C00200	ACXE04C00460	
⚠	38	SENSOR CO-AIR TEMP AND PIPE TEMP	1	CWA50C3079	←	O
	39	CABINET SIDE PLATE	1	CWE041858A	←	
	40	CABINET FRONT PLATE CO.	1	CWE06C1563	←	
	41	CABINET TOP PLATE	1	CWE031230A	←	
	42	PLATE - C. B. COVER TERMINAL	1	CWH131301	←	
	43	CONTROL BOARD COVER CO.	1	CWH13C1359	←	
	45	STRAINER	1	CWB11094	←	
	47	EXPANSION VALVE	1	ACXB05-01080	←	
	50	WIRE NET	1	ACXD04-00040A	←	
	52	BAG-COMPLETE	1	CWG87C900	←	
	53	PANASONIC BADGE	1	CWE373439	←	
	56	INSTALLATION INSTRUCTION	1	ACXF60-42621	←	
	57	INSTALLATION INSTRUCTION	1	ACXF60-42631	←	
	58	INSTALLATION INSTRUCTION	1	ACXF60-42641	←	
	59	INSTALLATION INSTRUCTION	1	ACXF60-42651	←	
	60	INSTALLATION INSTRUCTION	1	ACXF60-42661	←	
	61	INSTALLATION INSTRUCTION	1	ACXF60-42671	←	

SAFETY	REF. NO.	PART NAME & DESCRIPTION	QTY.	CU-Z20XKE	CU-Z25XKE	REMARK
	62	INSTALLATION INSTRUCTION	1	ACXF60-42681	←	
	63	INSTALLATION INSTRUCTION	1	ACXF60-42691	←	
	64	INSTALLATION INSTRUCTION	1	ACXF60-42701	←	
	65	INSTALLATION INSTRUCTION	1	ACXF60-42711	←	
	66	INSTALLATION INSTRUCTION	1	ACXF60-42721	←	
	67	BAG	1	CWG861078	←	
	68	BASE BOARD-COMPLETE	1	CWG62C1223	←	
	69	SHOCK ABSORBER - RIGHT	1	CWG713778	←	
	70	SHOCK ABSORBER - LEFT	1	CWG713779	←	
	71	C.C.CASE	1	ACXG50-48861	←	
	72	MODEL LABEL	2	ACXF85-62770	ACXF85-62780	

(NOTE)

- All parts are supplied from PAPAMY, Malaysia (Vendor Code: 00029488).
- "O" marked parts are recommended to be kept in stock.

SAFETY	REF. NO.	PART NAME & DESCRIPTION	QTY.	CU-Z35XKE	CU-Z42XKE	REMARK
	1	CHASSIS COMPLETE	1	CWD52K1399	←	
	2	FAN MOTOR BRACKET	1	CWD541157	←	
	3	SCREW - FAN MOTOR BRACKET	2	ACXH55-07140	←	
⚠	4	FAN MOTOR	1	L6CAYYYL0083	←	0
	5	SCREW - FAN MOTOR MOUNT	4	CWH55252J	←	
	6	PROPELLER FAN ASSY	1	CWH03K1100	←	
	7	NUT - PROPELLER FAN	1	CWH56053J	←	
⚠	8	COMPRESSOR	1	9RS102XRA21	←	0
	10	ANTI - VIBRATION BUSHING	3	CWH50077	←	
	11	NUT - COMPRESSOR MOUNT	3	CWH561096	←	
	12	CONDENSER	1	ACXB32C23130	←	
	14	DISCHARGE MUFFLER	1	CWB121021	←	
	15	HOLDER COUPLING	1	CWH351233	←	
	16	4-WAYS VALVE	1	ACXB00-01290	←	
	17	DISCHARGE MUFFLER(4 W.VALVE)	1	CWB121010	←	
	19	2-WAYS VALVE (LIQUID)	1	ACXB02-03310	←	
	20	3-WAY VALVE (GAS)	1	ACXB01-04540	ACXB01-02280	
	21	TERMINAL COVER	1	CWH171039A	←	
	22	NUT - TERMINAL COVER	1	CWH7080300J	←	
⚠	24	V-COIL COMPLETE - 4 WAY VALVE	1	ACXA43C00250	←	0
	25	O-RING	1	ACXB81-06510	←	
⚠	26	V-COIL COMPLETE - EXP.VALVE	1	ACXA43C06110	←	0
	27	SOUND PROOF BOARD	1	CWH151428	←	
⚠	28	REACTOR	1	G0C392J00037	G0C392J00050	0
	29	SOUND PROOF MATERIAL - TOP	1	CWG302314	←	
	30	SOUND PROOF MATERIAL - COMP. BODY	1	ACXG30-11540	←	
	31	SOUND PROOF MATERIAL	1	ACXG30-11800	←	
	32	SOUND PROOF MATERIAL	1	CWG302994	←	
⚠	33	SENSOR CO-COMP TEMP	1	ACXA50C17380	←	0
	34	CONTROL BOARD COVER-TOP	1	ACXH13-00450	←	
⚠	35	ELECTRONIC CONTROLLER - MAIN	1	ACXA73C72830R	ACXA73C72840R	0
	36	TERMINAL BOARD ASSY	1	CWA28K1298	←	
	37	CABINET SIDE PLATE CO.	1	ACXE04C00460	←	
⚠	38	SENSOR CO-AIR TEMP AND PIPE TEMP	1	CWA50C3079	←	0
	39	CABINET SIDE PLATE	1	CWE041858A	←	
	40	CABINET FRONT PLATE CO.	1	CWE06C1566	←	
	41	CABINET TOP PLATE	1	CWE031230A	←	
	42	PLATE - C. B. COVER TERMINAL	1	CWH131301	←	
	43	CONTROL BOARD COVER CO.	1	CWH13C1359	←	
	45	STRAINER	1	CWB11094	←	
	47	EXPANSION VALVE	1	ACXB05-01080	←	
	50	WIRE NET	1	ACXD04-00040A	←	
	52	BAG-COMPLETE	1	CWG87C900	←	
	53	PANASONIC BADGE	1	CWE373439	←	
	56	INSTALLATION INSTRUCTION	1	ACXF60-42621	←	
	57	INSTALLATION INSTRUCTION	1	ACXF60-42631	←	
	58	INSTALLATION INSTRUCTION	1	ACXF60-42641	←	

SAFETY	REF. NO.	PART NAME & DESCRIPTION	QTY.	CU-Z35XKE	CU-Z42XKE	REMARK
	59	INSTALLATION INSTRUCTION	1	ACXF60-42651	←	
	60	INSTALLATION INSTRUCTION	1	ACXF60-42661	←	
	61	INSTALLATION INSTRUCTION	1	ACXF60-42671	←	
	62	INSTALLATION INSTRUCTION	1	ACXF60-42681	←	
	63	INSTALLATION INSTRUCTION	1	ACXF60-42691	←	
	64	INSTALLATION INSTRUCTION	1	ACXF60-42701	←	
	65	INSTALLATION INSTRUCTION	1	ACXF60-42711	←	
	66	INSTALLATION INSTRUCTION	1	ACXF60-42721	←	
	67	BAG	1	CWG861078	←	
	68	BASE BOARD-COMPLETE	1	CWG62C1223	←	
	69	SHOCK ABSORBER - RIGHT	1	CWG713778	←	
	70	SHOCK ABSORBER - LEFT	1	CWG713779	←	
	71	C.C.CASE	1	ACXG50-48861	←	
	72	MODEL LABEL	2	ACXF85-62790	ACXF85-62800	

(NOTE)

- All parts are supplied from PAPAMY, Malaysia (Vendor Code: 00029488).
- "O" marked parts are recommended to be kept in stock.