

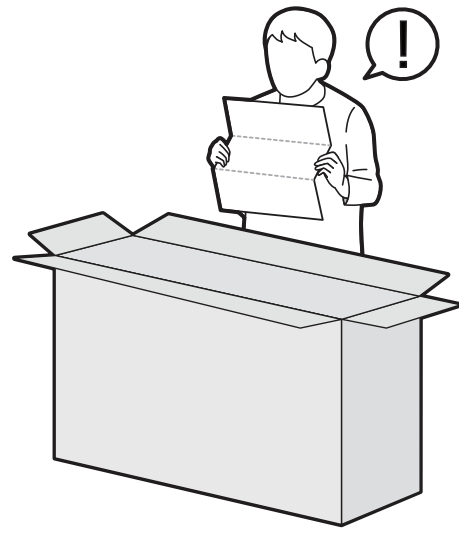

UP78*

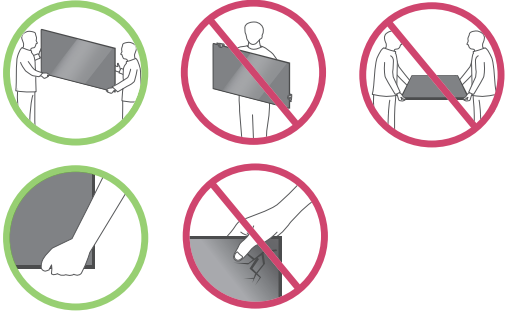

1
55UP78*

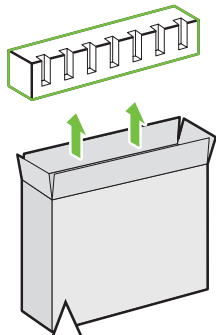

2

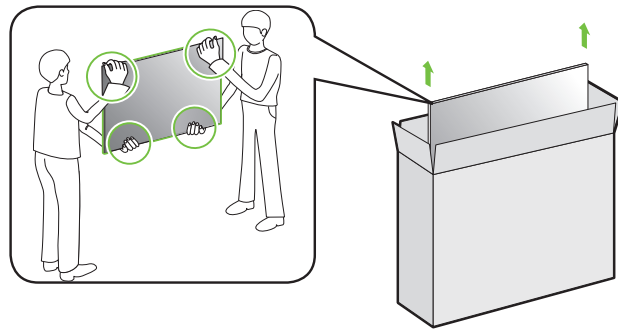

3

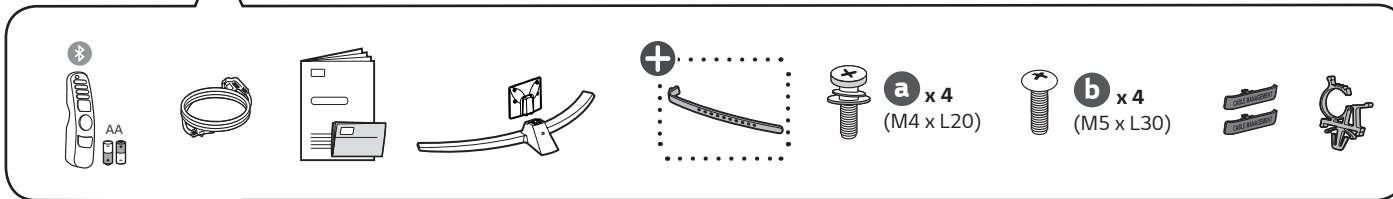
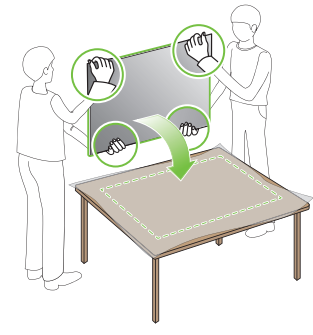

1
65UP78*

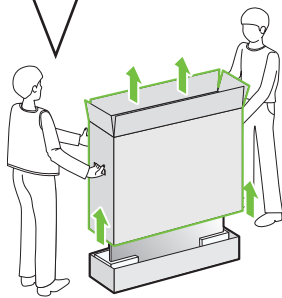

2

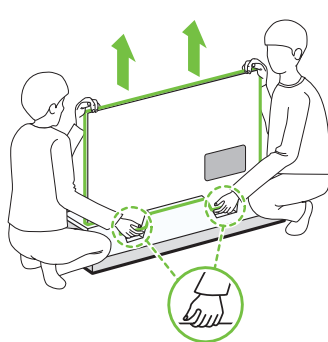

3

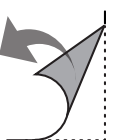
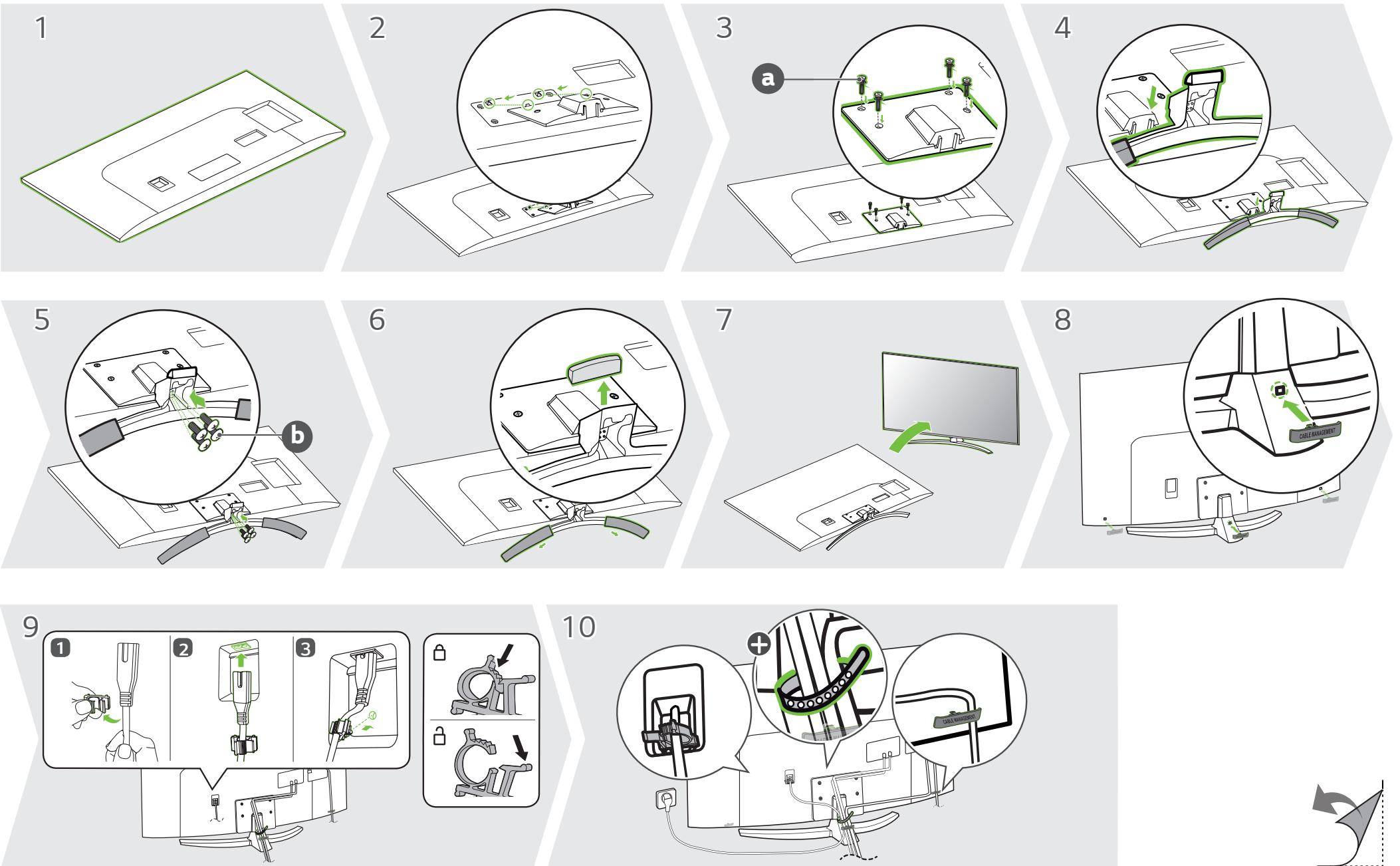
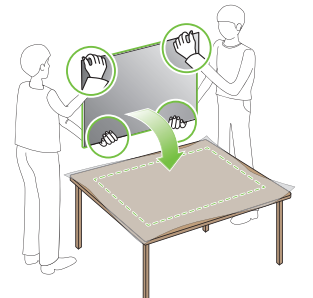

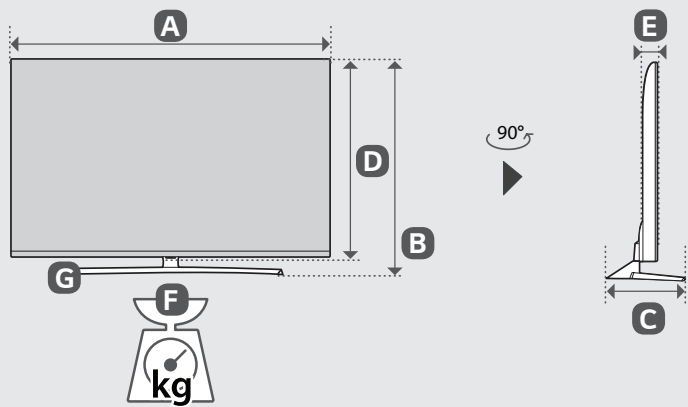
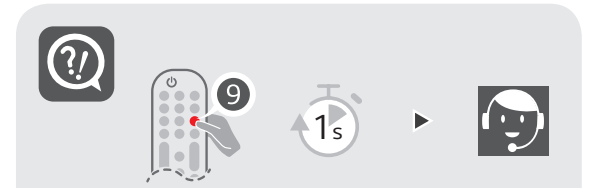
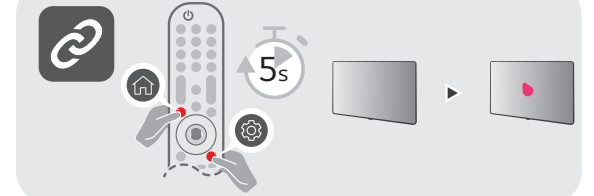
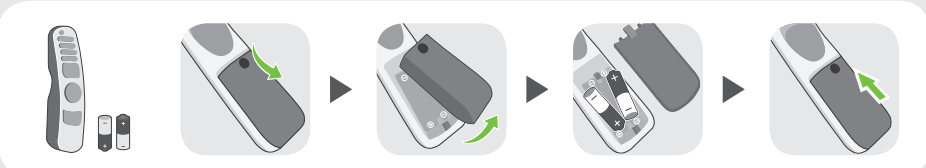
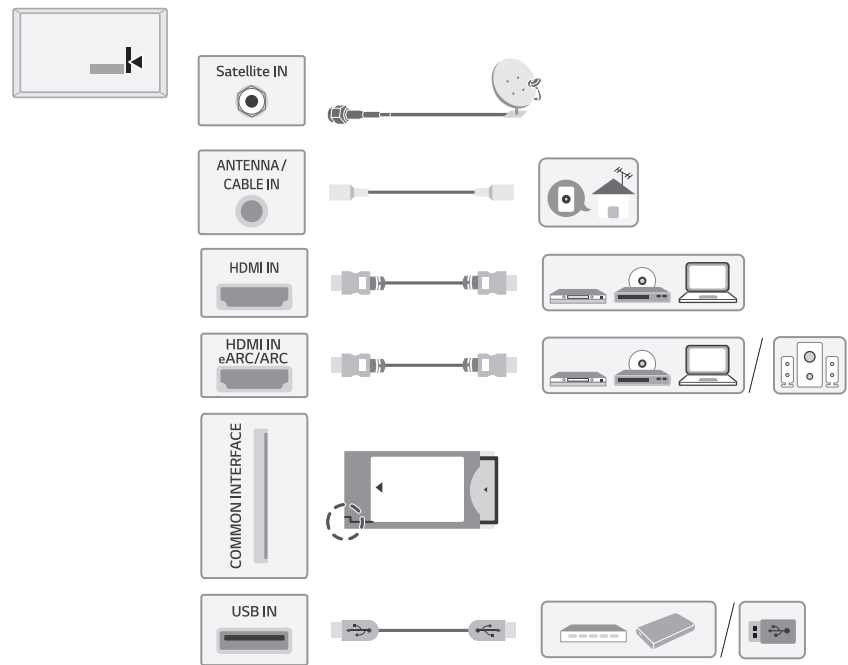
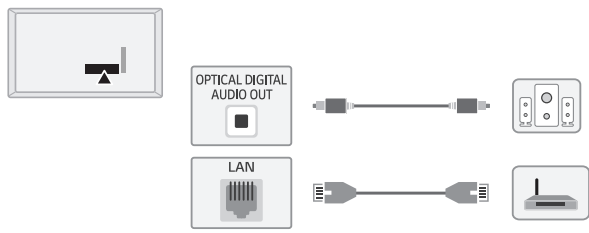

	A	B	C	D	E	F	F-G
	(mm)				(kg)		
55UP78003LB 55UP78006LB 55UP78006LC 55UP78009LB	1235	787	260	715	57.5	15.4	14.0
65UP78003LB 65UP78006LB 65UP78006LC 65UP78009LB	1454	909	340	838	57.7	22.9	21.5
Power requirement				AC 100-240 V - 50 / 60 Hz			



English · Read Safety and Regulatory.

Deutsch · Lesen Sie die Sicherheitsanweisungen und Richtlinien.

Français · Lire le document Sécurité et mesures réglementaires.

Italiano · Leggere il manuale Sicurezza e normative.

Español · Leer Seguridad y normativa.

Português · Ler informações sobre a Segurança e Regulamentos.

Nederlands · Veiligheidsinformatie en regelgeving lezen.

Ελληνικά · Διαβάστε τις οδηγίες για την ασφάλεια και τους κανονισμούς.

Slovenščina · Preberite varnostne in regulativne vidike.

Hrvatski · Pročitajte Sigurnost i uskladenost s propisima.

Shqip · Lexoni paragrafin "Siguria dhe rregullimi".

Bosanski · Pročitajte dio Sigurnost i propisi.

Македонски · Прочитajte за безбедноста и регулативата.

Svenska · Läs Säkerhet och föreskrifter.

Magyar · Biztonsági szabályzat megtekintése.

Polski · Prosimy o przeczytanie Zasad bezpieczeństwa i uwag dotyczących przepisów.

Česky · Přečtěte si část Bezpečnost a zákonné předpisy.

Slovenčina · Prečitajte si bezpečnostné a regulačné informácie.

Română · Consultați manualul referitor la siguranță și reglementare.

Български · Прочетете Безопасност и регулаторни стандарти.

Eesti · Lugege ohutus- ja normatiivteavet.

Lietuvių k. · Perskaitykite Saugos ir norminius reikalavimus.

Latviešu · Izlasiet sadaļu Drošība un normatīvi.

Srpski · Pročitajte odeljak Bezbednost i regulatorna pitanja.

Norsk · Les sikkerhet og forskrifter.

Dansk · Læs sikkerhed og lovmæssige bestemmelser.

Suomi · Lue Turvallisuus ja säännökset -osio.

⊕ : Depending on model / Abhängig vom Modell / Selon le modèle / In base al modello / En función del modelo / Dependendo do modelo / Afhankelijk van het model / Αν λογα με το μοντ λο / Odvisno od modela / Tipusfüggő / Zależnie od modelu / Závisí na modelu / V závislosti od modelu / In functie de model / в зависимости от модели / Sõltub mudelist / Priklauso nuo modelio / Atkarībā no modeļa / U zavisnosti od modela / Ovisno o modelu / Në varësi të modelit / Ovisno o modelu / во зависисот од моделот / Beroende på modell / Avhengig av modell / Afhængigt af modellen / Mallin mukaan