



ASSEMBLY INSTRUCTIONS

www.eurekaergonomic.com

MODEL # ERK-OC07

SERENE

TRUE ERGONOMICS, TRUE COMFORT



The image shown here is indicative only. If there is inconsistency between the image and the actual product, the actual product shall govern.

L'image indiquée ici est indicative uniquement. S'il y a une incohérence entre l'image et le produit réel, le produit réel gouverne.

La imagen que se muestra aquí es solo indicativa. Si hay inconsistencia entre la imagen y el producto real, el producto real regirá.

说明书图片仅供参考，具体请以实物为准。

If you need to return the goods, please keep **all** the packaging materials and return it in the original packaging!

Si vous devez retourner la marchandise, veuillez conserver tous les matériaux d'emballage et le retourner dans l'emballage d'origine!

Si necesita devolver los productos, conserve todos los materiales de embalaje y devuélvalos en el embalaje original!

如需退货请保留好所有包装材料，并按原包装包好退回!

PARTS / PIÈCES / PARTES / 部件清单



HARDWARE / MATÉRIEL / HARDWARE / 配件清单

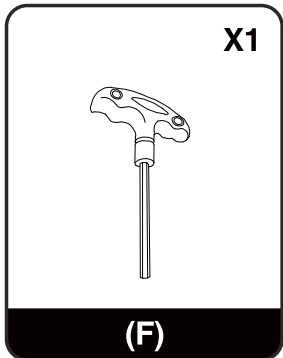
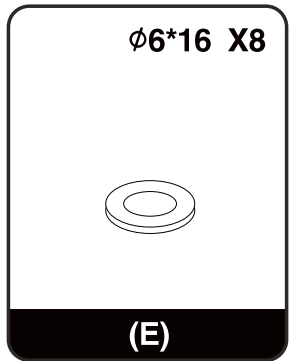
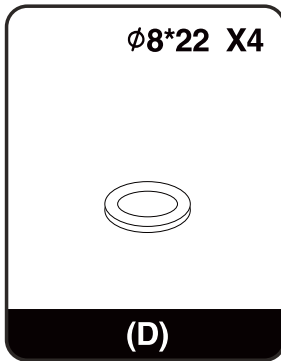
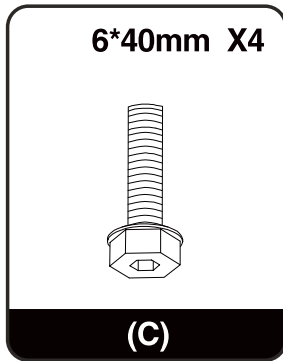
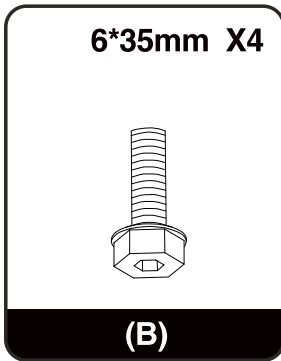
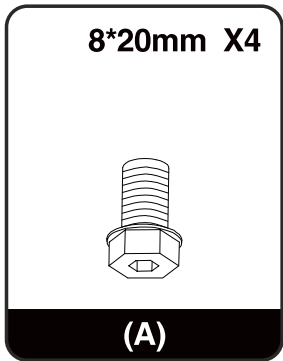



Do not tighten the screws until all of them are fastened into the holes.
Ne serrez pas les vis tant qu'elles ne sont pas toutes fixées dans les trous.
No apriete los tornillos hasta que todos estén fijados en los orificios.
安装时先不要把螺丝拧紧，等所有螺丝都拧到螺纹孔上再将全部螺丝拧紧。

ASSEMBLY INSTRUCTIONS

INSTRUCTIONS DE MONTAGE

INSTRUCCIONES DE MONTAJE

安装步骤

STEP 1

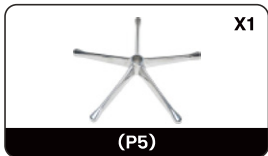

(P5)



(P7)

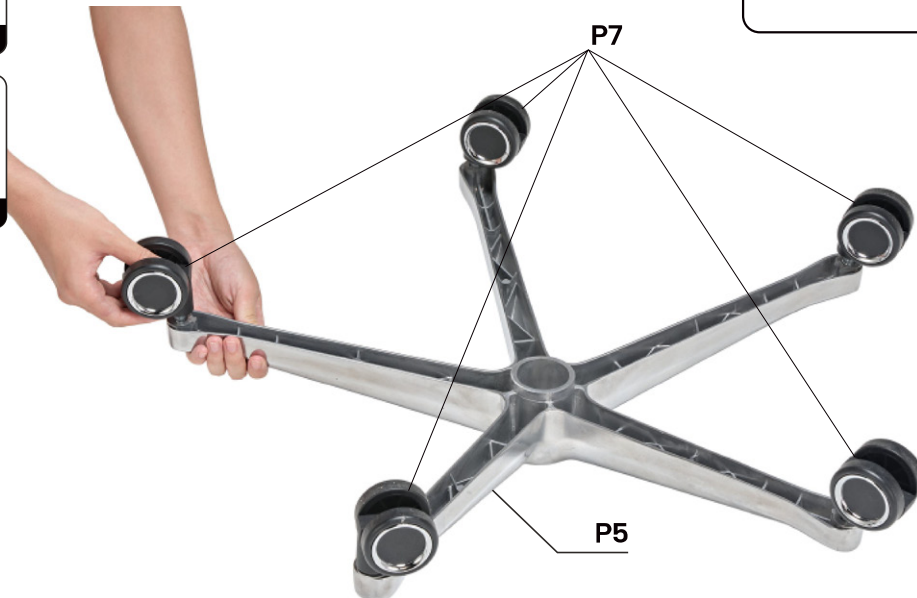
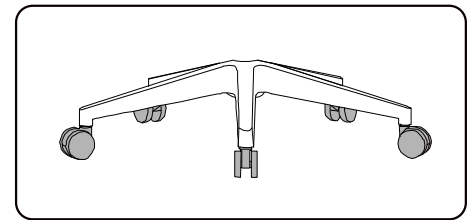

#1



#2

Push the casters into each end of the wheelbase.
Poussez les roulettes à chaque extrémité de l'empattement.
Introduzca las ruedas en cada uno de los extremos de la distancia entre ejes.
将脚轮推入五星脚。

STEP 2

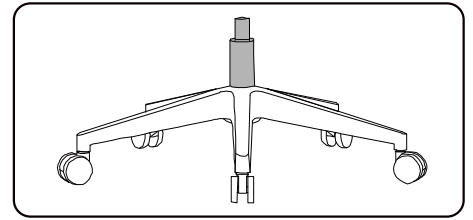
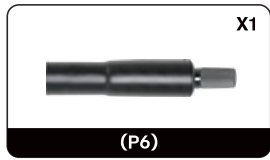

Insert the gas cylinder into the wheelbase and then remove the cap of the gas cylinder.

Insérez la bouteille de gaz dans l'empatement, puis retirez le bouchon de la bouteille de gaz.

Inserte la bombona de gas en la distancia entre ejes y, a continuación, retire el tapón de la bombona de gas.

将气杆插入五星脚，再取下气杆帽。

STEP 3

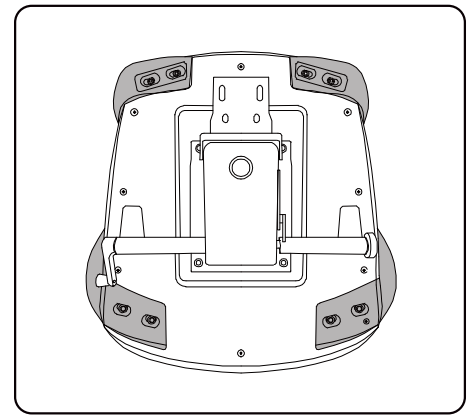
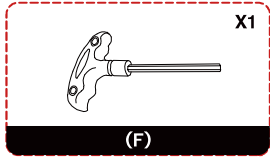
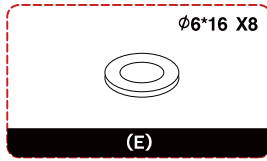
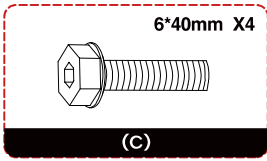
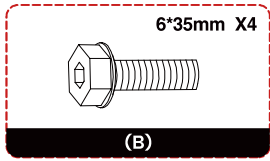
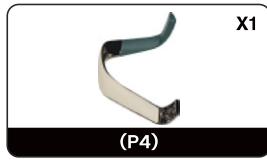
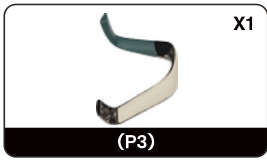

Install the armrests onto the bottom of the cushion. Use the screws and gaskets to make sure they are securely fastened. Note: distinguish between the left and right installation positions of the armrests.

Installez les accoudoirs sur la partie inférieure du coussin. Utilisez les vis et les joints pour vous assurer qu'ils sont bien fixés. Remarque : faites la distinction entre les positions d'installation gauche et droite des accoudoirs.

Instale los reposabrazos en la parte inferior del cojín. Asegúrese de que estén bien fijados. Nota: distinga entre las posiciones de instalación izquierda y derecha de los reposabrazos.

将扶手安装到坐垫底部，用螺丝和垫片固定。注意区分扶手左右安装位置。

STEP 4

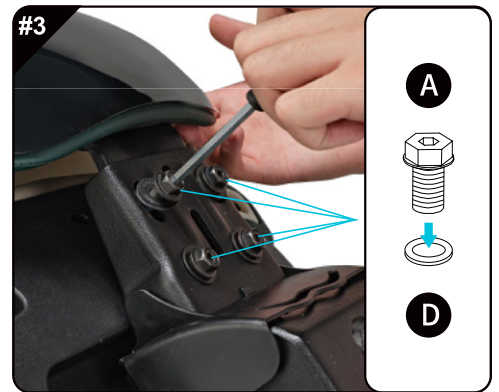
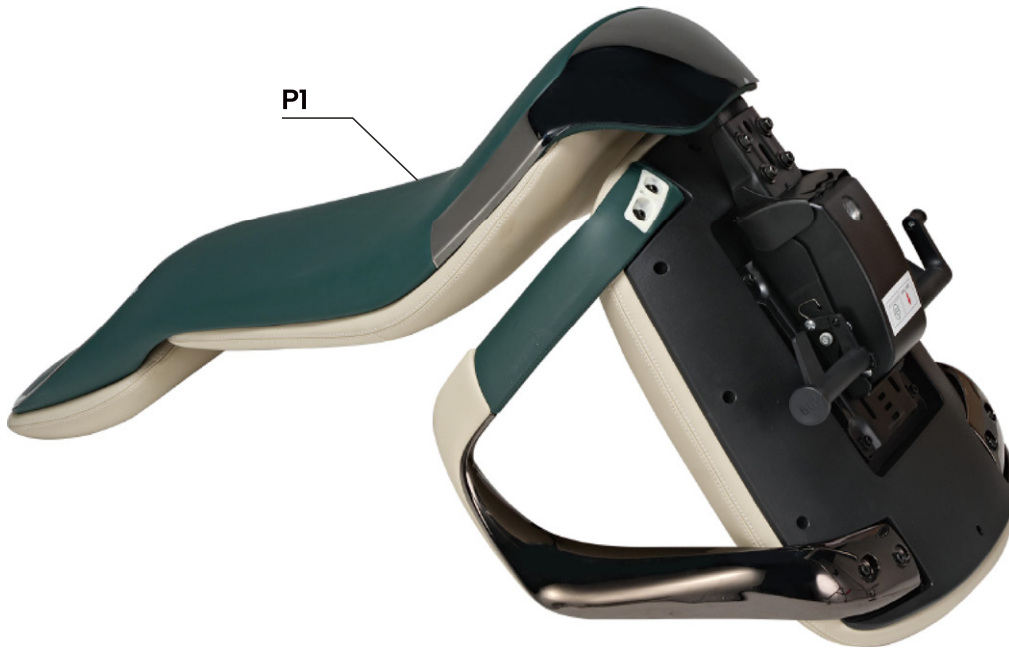
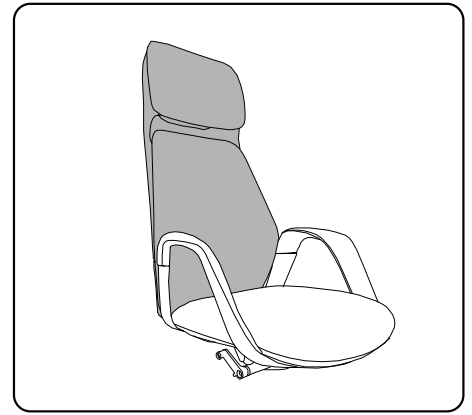
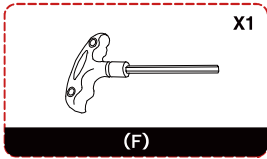
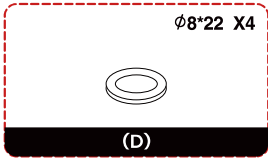
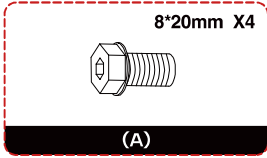

Install the backrest to the tilt mechanism. Be aware that the placement should be correctly aligned. Use the screws and iron washers to make sure the backrest is securely fastened.

Installez le dossier sur le mécanisme de basculement. Veillez à ce que l'emplacement soit correctement aligné. Utilisez les vis et les rondelles en fer pour vous assurer que le dossier est solidement fixé.

Instale el respaldo en el mecanismo de inclinación. Tenga en cuenta que la colocación debe estar correctamente alineada. Utilice los tornillos y las arandelas de hierro para asegurarse de que el respaldo está bien sujeto.

将靠背安装到底盘上，用螺丝和铁圈固定锁紧。

STEP 5



Insert the gas cylinder into the socket of the tilt mechanism.
Insérez la bouteille de gaz dans la douille du mécanisme d'inclinaison.
Inserte el cilindro de gas en la toma del mecanismo de inclinación.
将五星脚和气杆组件安装到底盘上。



OPERATION INSTRUCTIONS

INSTRUCTIONS DE FONCTIONNEMENT

INSTRUCCIONES DE USO

操作指引

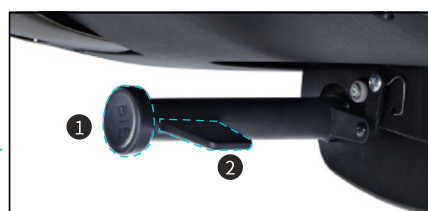

- ① Rotate this round head to lock or unlock the rocking function. Clockwise—Unlock the rocking. Anticlockwise—Lock the rocking.
Tournez cette tête ronde pour verrouiller ou déverrouiller la fonction de basculement. Anti-horaire : bloque la fonction de basculement.
Gire este cabezal redondo para bloquear o desbloquear la función de balanceo. Antihorario: bloquea el balanceo.
扭动操控杆头部, 可进行倾仰锁定与解锁。顺时针扭动, 解锁倾仰, 逆时针扭动, 锁定倾仰。
- ② Pull and hold this lever up to adjust the seat depth.
Tirez et maintenez ce levier vers le haut pour régler la profondeur du siège.
Tire y mantenga esta palanca hacia arriba para ajustar la profundidad del asiento.
按住操控杆可调节座深。



- ③ Anticlockwise—Reclining resistance decrease. Clockwise—Reclining resistance increase.
Antihoraire - Diminution de la résistance à l'inclinaison.
Dans le sens des aiguilles d'une montre - Augmentation de la résistance à l'inclinaison.
Antihorario - Disminución de la resistencia a la inclinación.
Aumento de la resistencia a las agujas del reloj.
逆时针旋转, 后仰阻力减弱。顺时针旋转, 后仰阻力增强。
- ④ To rise the seat height, pull this lever up (No need to be seated). To lower down the seat height, pull this lever up again (Sitting is necessary).
Pour augmenter la hauteur du siège, tirez ce levier vers le haut (il n'est pas nécessaire d'être assis). Pour abaisser la hauteur du siège, tirez à nouveau ce levier vers le haut (il est nécessaire de s'asseoir).
Para subir la altura del asiento, tire de esta palanca hacia arriba (No es necesario estar sentado). Para bajar la altura del asiento, vuelva a tirar de esta palanca hacia arriba (Es necesario estar sentado).
调节座椅的高度, 拉起这个把手 (不能坐着), 降低座椅的高度, 再次拉起这个把手 (必须坐着)。