

**IMPORTANT! KEEP THIS MANUAL  
FOR FUTURE REFERENCE!**

## **INSTRUCTION MANUAL FOR USE OF BABY STROLLER “AMBER”**

**AMBER**

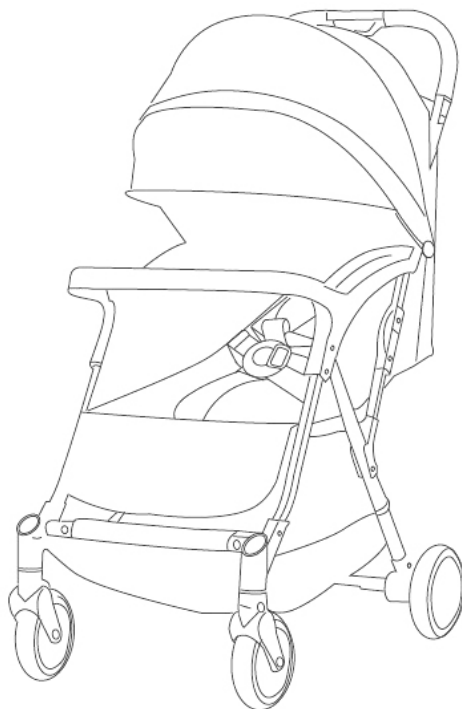

This stroller **chipolino** is manufactured according to the requirements of the Product Safety Directive 2001/95/EU of the European Parliament and The Council and with European standards EN 1888-1:2018 Child use and care articles. Wheeled child conveyances. Part 1: Pushchairs and prams and EN 1888-2:2018 Child care articles - Wheeled child conveyances - Part 2: Pushchairs for children above 15 kg up to 22 kg and the regulations of national legislation.

**FOLLOW ALL WARNINGS, INSTRUCTIONS AND  
RECOMMENDATIONS IN THIS MANUAL IN ORDER  
TO GUARANTEE THE SAFE USE OF THIS PRODUCT!**

**CAUTION! WARNINGS!**

- ❖ **WARNING!** NEVER LEAVE YOUR CHILD UNATTENDED!
- ❖ **WARNING!** ALWAYS USE THE RESTRAINT SYSTEM (SAFETY BELTS) ONCE THE CHILD CAN SIT UNAIDED!
- ❖ **WARNING!** MAKE SURE THAT ALL LOCKING MECHANISMS ARE ENGAGED BEFORE EACH USE!
- ❖ **WARNING!** BEFORE EACH USE, CHECK THE STABILITY OF FIXING OF SEPARATE PARTS!
- ❖ **WARNING!** MAKE SURE YOUR CHILD IS AT SAFE DISTANCE AWAY FROM THE STROLLER DURING ADJUSTMENTS, FOLDING OR UNFOLDING OF THE STROLLER.
- ❖ **WARNING!** DO NOT ALLOW YOUR CHILDREN TO PLAY WITH THE STROLLER!
- ❖ **WARNING!** THIS PRODUCT IS NOT SUITABLE FOR RUNNING OR SKATING!
- ❖ FOR NEWBORN BABIES, USE THE MOST RECLINED POSITION OF THE BACKREST OF THE SEAT! ALWAYS ATTACH THE CANOPY TO THE BACKREST TO PREVENT THE BABY TO FALL AND INJURE!
- ❖ USE THE POSITION OF THE BACKREST FOR THE SITTING POSITION OF THE CHILD AFTER 6 MONTHS AGE! THE POSITION OF THE BACKREST IN "SITTING" POSITION IS NOT SUITABLE FOR CHILDREN UP TO 6 MONTHS!
- ❖ **DO NOT LIFT THE STROLLER BY THE SAFETY BAR!**
- ❖ **KEEP AWAY FROM FIRE!**
- ❖ To be used for a child with weight up to 22 kg.
- ❖ Adult assembly is required!
- ❖ Always activate the parking device when you put the children in or out of the stroller!
- ❖ Make sure the safety belts are correctly fastened and adjusted before each use.
- ❖ Do not put additional mattress in the stroller!
- ❖ The maximum load for the storage basket is 3 kg!
- ❖ The maximum load for the diaper bag (if you use one) must not exceed 2 kg!
- ❖ Do not overload the stroller! Every load attached to the handle, bumper, and backrest or on the side of the stroller will affect its stability!

- ❖ To be used for one child only at a time. Do not place two or more children in the stroller!
- ❖ Only use spare parts or other components, which are recommended or supplied by the producer! In the contrary case the producer is not responsible for the product's safety.
- ❖ Do not make any changes or modifications to the stroller's construction! In case of problems contact the dealer or an authorized repair service for advice and/or repair.
- ❖ Do not use this stroller if you find missing or damaged parts!
- ❖ Do not allow children younger than 3 years near the stroller during its assembly!
- ❖ Do not attach any strings or long cords to the stroller in order to avoid risk of suffocation!
- ❖ Do not use the stroller on stairs or escalators and pay attention when overcoming a curb or a step.
- ❖ Keep the plastic packaging away from children in order to avoid risk of suffocation!



## PRODUCT FEATURES

- ❖ This stroller is intended for infants or babies under 4 years of age or weighing up to 22 kg (whichever comes first);
- ❖ 5-point safety harness;
- ❖ Adjustable backrest;
- ❖ Adjustable canopy;
- ❖ Adjustable leg rest;

## MAIN PARTS

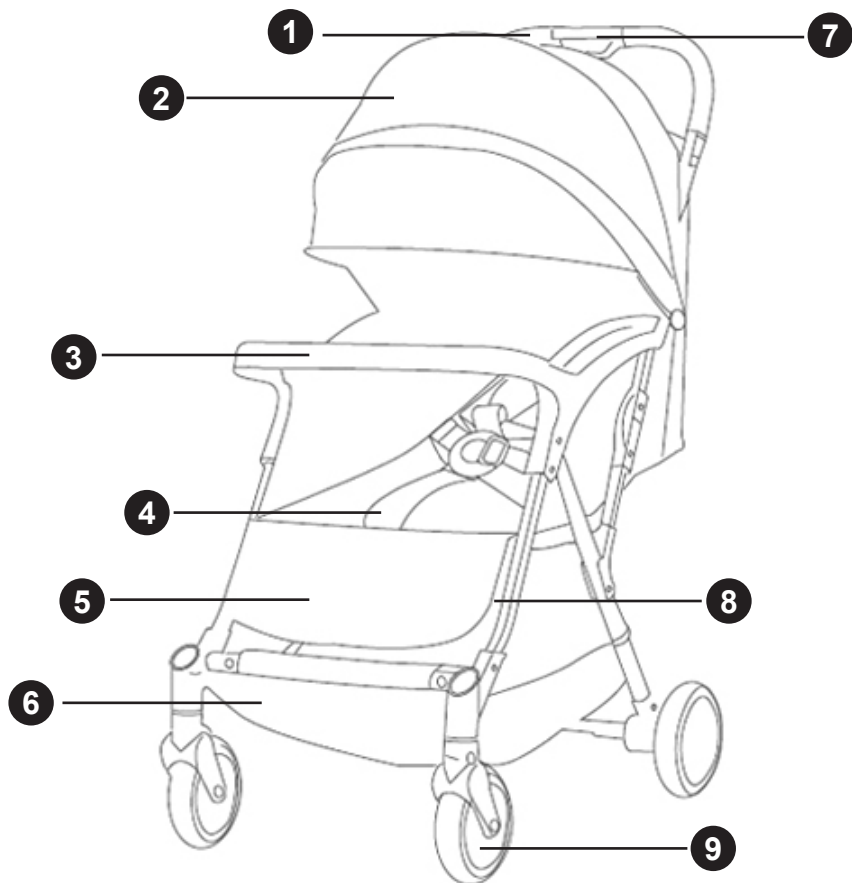

- 1 – Handle
- 2 – Canopy
- 3 – Front bumper
- 4 – Safety belts (restraint system)
- 5 – Leg rest
- 6 – Storage basket
- 7 – Folding mechanism
- 8 – Pull handle
- 9 – Front wheels

## ASSEMBLY INSTRUCTIONS AND FUNCTIONS

This stroller is supplied partially assembled. In order to complete the assembly, you do not need any tools.

**IMPORTANT!** Follow exactly the instructions given and check the pictures.

**IMPORTANT!** After each operation, make sure that you have followed the instructions correctly and the fixing is stable!

**IMPORTANT!** In most cases after the completion of an operation you will hear a clicking sound.

## ASSEMBLY

The assembly, disassembly and functions are numbered from 1 to 11. Use the operations descriptions given in this manual and their matching picture.

### 1 – UNFOLDING THE STROLLER

Hold the handle with your hands and pull it up (2) until you hear a “clicking” sound and the stroller locks into the unfolded position (3).

### 2 – ASSEMBLY OF FRONT WHEELS

Attach the front wheel (B) to the opening (A) on the frame and install with pressure, until you hear a “click” sound. Make sure the wheel is locked as you try to pull it off the axle.

### 3 – ASSEMBLY AND REMOVAL OF REAR WHEELS

Place the rear wheel (J) to the opening on the rear axle and install with pressure, until you hear a “click” sound.

To remove the wheel, pull the lever, „K” and take out the wheel.

### 4 – ASSEMBLY OF FRONT BUMPER

Place the bumper at the front and press firmly until you hear a „click” and bumper is fixed.

To remove the bumper, press the buttons (c) on bottom of bumper and take out the bumper.

## FUNCTIONS

### 5 – ADJUSTING THE POSITION OF THE BACKREST

**WARNING!** BABY UNDER 6 MONTHS TO BE PLACED ON THE SEAT ONLY WITH THE BACKREST, ADJUSTED IN THE MOST RECLINED (FLAT) POSITION!

Press the button on the backrest belt (1) and move the backrest up or down.

### 6 – LEG REST

Lift the leg rest and pull out the pull handle under it as shown in the picture.

In order to lower the leg rest, simply retract the pull handle back and the leg rest will be down.

## 7 – PARKING DEVICE

Press down the parking device (N), to activate it and stop the stroller.

Lift up the parking device (M), to release it and the stroller to move again.

**WARNING!** Always engage the parking device, when the stroller is stationary to avoid the risk of slipping of the stroller!

## 8 – CANOPY

Pull the canopy to open it (1).

Push with your hand to fold the canopy (2).

**WARNING!** Always attach the canopy to the backrest to prevent the baby to fall and injure!

Attach the cup holder to the handle of the stroller and press, until you hear clicking sound.

## 9 – RESTRAINT SYSTEM (safety belts).

9-1 – Insert the belts in the central buckle (1), until you hear a „click“.

9-2 – To unfasten the belts press the central buckle (1).

9-3 – Adjust the length of the belts by sliding the buckles (2).

**Remark:** Belt must be snug to child's body and must not be twisted

**WARNING!** Periodically check to ensure that the seat belt is securely attached to the stroller frame as well as securely fastened. The belts should not be worn or torn, and plastic buckles and fasteners must be sturdy, free of damage and secure.

**WARNING!** USE THE RESTRAINT SYTEM AT ALL TIMES SINCE THE BABY IS BORN! ADJUST THE BELTS LENGTH ACCORDING TO BABY'S NEEDS!

## 10 – FOLDING THE STROLLER

**IMPORTANT!** Before folding the stroller, always activate the parking device; adjust the position the backrest in the most upright position and empty the storage basket.

10-1 Press button D and then button E;

10-2 Press the handle forward (2) until the stroller get folded;

10-3 Lock the stroller with the transport hook (F).

## 11 – PULL HANDLE

The pull handle is located under the seat.

After the stroller is folded, pull out the handle with your hand (A). When handle is fully extended you will hear a „click“.

You can use the handle to move your stroller by pulling it.

Push the handle back (B), in order to hide it.

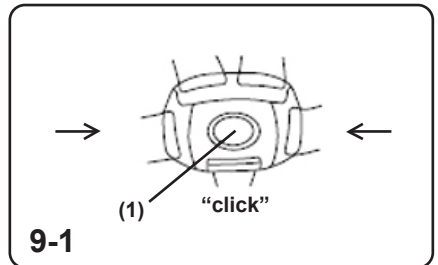
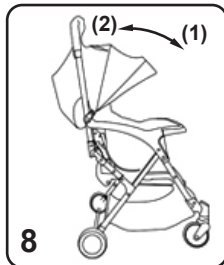
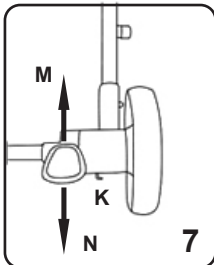
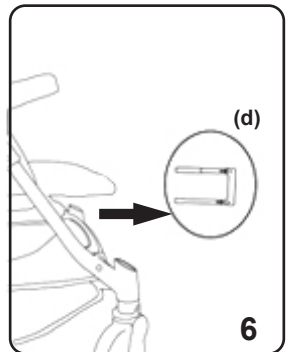
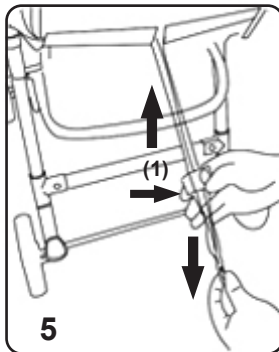
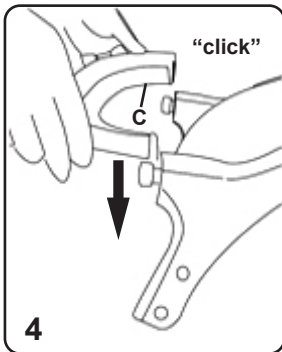
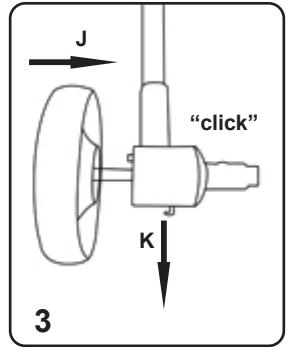
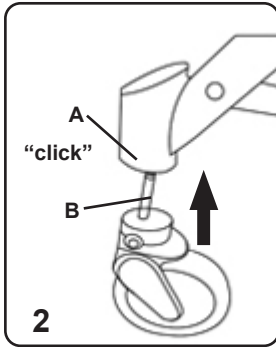
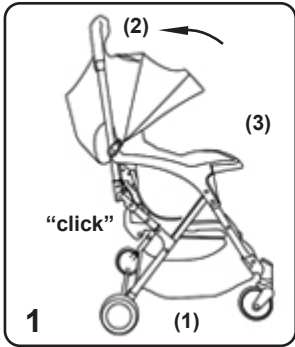

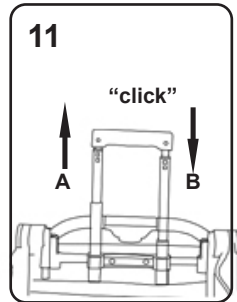
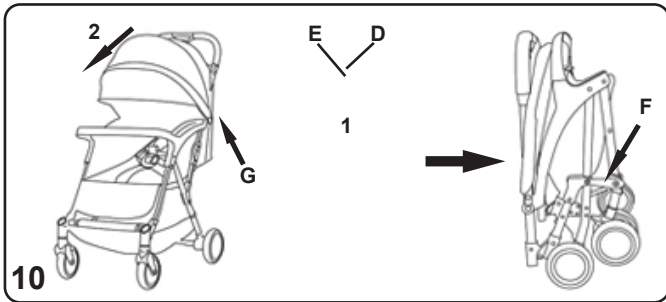
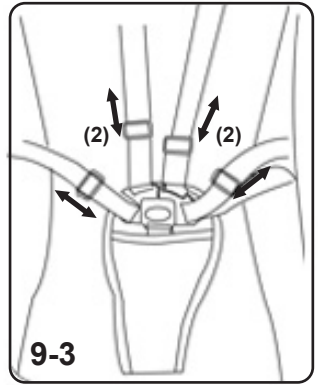
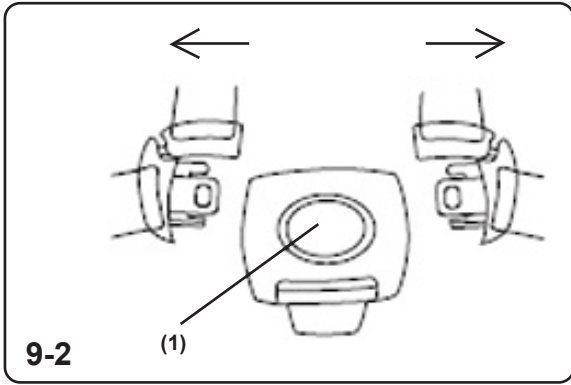



## CARE AND MAINTENANCE GUIDELINES

- ❖ The brakes and wheels wear out faster than other parts. Replace them when necessary.
- ❖ Regularly oil the moving parts. Use silicone oil or silicone spray for oiling.
- ❖ Clean and oil all dirty metal and plastic parts regularly.
- ❖ Clean the fabrics, plastic parts and metal parts with damp cotton cloth or sponge and mild soap.
- ❖ Do not use aggressive detergents, solvents, bleach or spirits to clean your stroller.
- ❖ Always leave the stroller to fully dry after cleaning before you use it or store it. Mold could form if you keep your stroller moist.
- ❖ Always store your stroller indoors in clean and dry place. Do not expose to direct environment influence - sun, rain, moisture and high temperature intervals.
- ❖ Please, contact your authorized dealer for problems connected with the use or repair of this stroller.

### Fabric Composition:

**Outer:** 100% Polyester

**Filling:** 100% Polyester



LKAB02xxxxx



---

Bulgaria, Plovdiv, str. Golyamokonarskoshosse 1

[www.chipolino.com](http://www.chipolino.com)