



Refrigerator

User manual

RB3*T*/RL3*T*/RB3*A*/RL3*A*/RB3*B*/RL3*B*

SEUK / SAPL

Free Standing Appliance

SAMSUNG



Contents

Safety information	4
What you need to know about the safety instructions	4
Important safety symbols and precautions:	6
Important safety precautions	7
Severe warning signs for transportation and site	10
Critical installation warnings	11
Installation cautions	14
Critical usage warnings	15
Usage cautions	20
Cleaning cautions	23
Critical disposal warnings	25
Additional tips for proper usage	26
Instructions about the WEEE	27
Installation	28
Refrigerator at a glance	28
Step-by-step installation	29
Operations	35
Control panel (applicable models only)	35
SmartThings (applicable models only)	41
Special features	44
Maintenance	48
Reversing the door handle position (For models with bar handles)	48
Door reversal (applicable models only)	49
Handle and care	63
Cleaning	65
Replacement	66
Pair installation (applicable models only)	67
Troubleshooting	74
General	74
Do you hear abnormal sounds from the refrigerator?	76
SmartThings (applicable models only)	78
Appendix	79
Safety Instruction	79
Install Instruction	79
Temperature Instruction	80
Information for model and ordering spare parts	83



Open Source Announcement

84

Contents

English 3

Safety information

Before using your new Samsung Refrigerator, please read this manual thoroughly to ensure that you know how to operate the features and functions that your new appliance offers safely and efficiently.

What you need to know about the safety instructions

- Warnings and Important Safety Instructions in this manual do not cover all possible conditions and situations that may occur.
It is your responsibility to use common sense, caution, and care when installing, maintaining, and operating your appliance.
- Because these following operating instructions cover various models, the characteristics of your refrigerator may differ slightly from those described in this manual and not all warning signs may be applicable. If you have any questions or concerns, contact your nearest service center or find help and information online at www.samsung.com.
- R-600a or R-134a is used as a refrigerant. Check the compressor label on the rear of the appliance or the rating label inside the fridge to see which refrigerant is used for your appliance. When this product contains flammable gas (Refrigerant R-600a), contact your local authority in regard to safe disposal of this product.
- In order to avoid the creation of a flammable gas-air mixture if a leak in the refrigerating circuit occurs, the size of the room in which the appliance may be sited depends on the amount of refrigerant used.

-
- Never start up an appliance showing any signs of damage. If in doubt, consult your dealer. The room must be 1 m³ in size for every 8 g of R-600a refrigerant inside the appliance.

The amount of refrigerant in your particular appliance is shown on the identification plate inside the appliance.

- Refrigerant squirting out of the pipes could ignite or cause an eye injury. When refrigerant leaks from the pipe, avoid any naked flames and move anything flammable away from the product and ventilate the room immediately.
 - Failing to do so may result in fire or explosion.
- To avoid contamination of food, please respect the following instructions:
 - Opening the door for long periods can cause a significant increase of the temperature in the compartments of the appliance.
 - Clean regularly surfaces that can come in contact with food and accessible drainage systems.
 - Clean water tanks if they have not been used for 48 h; flush the water system connected to a water supply if water has not been drawn for 5 days.
 - Store raw meat and fish in suitable containers in the refrigerator, so that it is not in contact with or drip onto other food.
 - Two-star frozen-food compartments are suitable for storing pre-frozen food, storing or making icecream and making ice cubes.
 - One-, two- and three-star compartments are not suitable for the freezing of fresh food.

Safety information

- If the refrigerating appliance is left empty for long periods, switch off, defrost, clean, dry, and leave the door open to prevent mould developing within the appliance.

Important safety symbols and precautions:

Please follow all safety instructions in this manual. This manual uses the following safety symbols.

WARNING

Hazards or unsafe practices that may result in **severe personal injury, property damage, and/or death.**

CAUTION

Hazards or unsafe practices that may result in **severe personal injury and/or property damage.**

NOTE

Useful information that helps users understand or benefit from the refrigerator.

These warning signs are here to prevent injury to you and others.

Please follow them carefully.

After reading this section, keep it in a safe place for future reference.

Important safety precautions



Warning; Risk of fire / flammable materials

WARNING

- When positioning the appliance, ensure the supply cord is not trapped or damaged.
- Do not locate multiple portable socket-outlets or portable power supplies at the rear of the appliance.
- Fill with potable water only.
- Connect to potable water supply only.
- Keep ventilation openings, in the appliance enclosure or in the built-in structure, clear of obstruction.
- Do not use mechanical devices or any other means to accelerate the defrosting process, other than those recommended by the manufacturer.
- Do not damage the refrigerant circuit.
- Do not use electrical appliances inside the food storage compartments of the appliance, unless they are of the type recommended by the manufacturer.
- This appliance is not intended for use by persons (including children) with reduced physical, sensory, or mental capabilities, or those who lack experience and knowledge, unless they have been given supervision or instruction concerning the use of the appliance by a person responsible for their safety.

Safety information

- This appliance can be used by children aged from 8 years and above and persons with reduced physical, sensory or mental capabilities or lack of experience and knowledge if they have been given supervision or instruction concerning use of the appliance in a safe way and understand the hazards involved. Children shall not play with the appliance. Cleaning and user maintenance shall not be made by children without supervision. Children aged from 3 to 8 years are allowed to load and unload refrigerating appliances.
- If the supply cord is damaged, it must be replaced by the manufacturer, its service agent or similarly qualified persons in order to avoid a hazard.
- The socket must be easily accessible so that the appliance can be quickly disconnected from the supply in an emergency.
 - It must be outside the area of the rear of the appliance.
- Do not store explosive substances such as aerosol cans with a flammable propellant in this appliance.
- If the product is equipped with LED lamps, do not disassemble the Lamp Covers and LED lamps yourself.
 - Contact a Samsung service center.
 - Use only the LED Lamps provided by the manufacturer or its service agents.
- For the most efficient use of energy, please keep the all inner fittings such as baskets, drawers, shelves on the position supplied by manufacturer.
- To get the best energy efficiency of this product, please leave all shelves, drawers and baskets on their original position.

How to minimize the energy consumption

- Install the appliance in a cool, dry room with adequate ventilation.
- Ensure that it is not exposed to direct sunlight and never put it near a direct source of heat (radiator, for example).
 - Not to block any vents or grilles is recommended for energy efficiency.
 - Allow warm food to cool down before placing it in the appliance.
 - Put frozen food in the refrigerator to thaw. You can then use the low temperatures of the frozen products to cool food in the refrigerator.
 - Do not keep the door of the appliance open for too long when putting food in or taking food out.
 - The shorter time for which the door is open, the less ice will form in the freezer.
 - Clean the rear of the refrigerator regularly. Dust increases energy consumption.
 - Do not set temperature colder than necessary.
 - Ensure sufficient air exhaust at the refrigerator base and at the back wall of the refrigerator. Do not cover air vent openings.
 - Allow clearance to the right, left, back and top when installing. This will help reduce power consumption and keep your energy bills lower.
- We recommend the value of clearance to be :
 - Right, left, and back side: more than 50 mm
 - Top side: more than 100 mm

Safety information

This appliance is intended to be used in household and similar applications such as

- staff kitchen areas in shops, offices and other working environments;
- farm houses and by clients in hotels, motels and other residential type environments;
- bed and breakfast type environments;
- catering and similar non-retail applications.

Severe warning signs for transportation and site

WARNING

- When transporting and installing the appliance, care should be taken to ensure that no parts of the refrigerating circuit are damaged.
 - Refrigerant leaking from the pipe work could ignite or cause an eye injury. If a leak is detected, avoid any naked flames or potential sources of ignition and air the room in which the appliance is standing for several minutes.
 - This appliance contains a small amount of isobutane refrigerant (R-600a), a natural gas with high environmental compatibility that is, however, also combustible. When transporting and installing the appliance, care should be taken to ensure that no parts of the refrigerating circuit are damaged.

Critical installation warnings

WARNING

- Do not install the refrigerator in a damp location or place where it may come in contact with water.
 - Deteriorated insulation on electrical parts may cause an electric shock or fire.
- Do not place this refrigerator in direct sunlight or expose it to the heat from stoves, room heaters, or other appliances.
- Do not plug several appliances into the same multiple power strip. The refrigerator should always be plugged into its own individual electrical outlet which has a voltage rating that matches the voltage listed on the refrigerator's rating plate.
 - This provides the best performance and also prevents overloading of house wiring circuits, which could cause a fire hazard from overheated wires.
- If the wall socket is loose, do not insert the power plug.
 - There is a risk of electric shock or fire.
- Do not use a power cord that has cracks or abrasion damage along its length or at either end.
- Do not bend the power cord excessively or place heavy objects on it.
- Do not pull or excessively bend the power cord.
- Do not twist or tie the power cord.
- Do not hook the power cord over a metal object, place a heavy object on the power cord, insert the power cord between objects, or push the power cord into the space behind the appliance.

Safety information

- When moving the refrigerator, be careful not to roll over or damage the power cord.
 - This may result in an electric shock or fire.
- Never unplug your refrigerator by pulling on the power cord. Always grip the plug firmly and pull straight out from the outlet.
 - Damage to the cord may cause a short-circuit, fire, and/or electric shock.
- Do not use aerosols near the refrigerator.
 - Using aerosols near the refrigerator may cause an explosion or fire.
- Do not install this appliance near a heater or inflammable material.
- Do not install this appliance in a location where gas may leak.
 - This may result in an electric shock or fire.
- This refrigerator must be properly located and installed in accordance with the instructions in this manual before you use it.
- Connect the power plug in the proper position with the cord hanging down.
 - If you connect the power plug upside down, the wire can get cut off and cause a fire or electric shock.
- Make sure that the power plug is not crushed or damaged by the back of the refrigerator.
- Keep the packing materials out of reach of children.
 - There is a risk of death from suffocation if a child puts the packing materials on his or her head.

-
- Do not install this appliance in a humid, oily or dusty location, in a location exposed to direct sunlight and water (rain drops).
 - Deteriorated insulation of electrical parts may cause an electric shock or fire.
 - If any dust or water is in the refrigerator, pull out power plug and contact your Samsung Electronics service center.
 - Otherwise there is a risk of fire.
 - Do not stand on top of the appliance or place objects (such as laundry, lighted candles, lighted cigarettes, dishes, chemicals, metal objects, etc.) on the appliance.
 - This may result in an electric shock, fire, problems with the product, or injury.
 - You need to remove all the protective plastic film before you initially plug the product in.
 - Children should be supervised to ensure that they do not play with the snap rings used for door adjustment or the water tube clips.
 - There is risk of death by suffocation if a child swallows a snap ring or water tube clip. Keep the snap rings and water tube clips out of children's reach.
 - The refrigerator must be safely grounded.
 - Always make sure that you have grounded the refrigerator before attempting to investigate or repair any part of the appliance. Power leakages can cause severe electric shock.

Safety information

- Never use gas pipes, telephone lines, or other potential lightning attractors as an electrical ground.
 - You must ground the refrigerator to prevent any power leakages or electric shocks caused by current leakage from the refrigerator.
 - This may result in an electric shock, fire, explosion, or problems with the product.
- Plug the power plug into the wall socket firmly. Do not use a damaged power plug, damaged power cord, or loose wall socket.
 - This may result in an electric shock or fire.
- The fuse on the refrigerator must be changed by a qualified technician or service company.
 - Failing to do so may result in an electric shock or personal injury.

Installation cautions

CAUTION

- Allow sufficient space around the refrigerator and install it on a flat surface.
 - If your refrigerator is not level, cooling efficiency and durability can be declined.
- Allow the appliance to stand for 2-3 hours before loading foods after installation and turning on.
- We strongly recommend you have a qualified technician or service company install the refrigerator.
 - Failing to do so may result in an electric shock, fire, explosion, problems with the product, or injury.

Critical usage warnings

WARNING

- Do not insert the power plug into a wall socket with wet hands.
 - This may result in an electric shock.
- Do not store articles on the top of the appliance.
 - When you open or close the door, the articles may fall and cause personal injury and/or material damage.
- Do not insert hands, feet or metal objects (such as chopsticks, etc.) into the bottom or the back of the refrigerator.
 - This may result in an electric shock or injury.
 - Any sharp edges may cause a personal injury.
- Do not touch the inside walls of the freezer or products stored in the freezer with wet hands.
 - This may cause frostbite.
- Do not put a container filled with water on the refrigerator.
 - If spilled, there is a risk of fire or electric shock.
- Do not keep volatile or flammable objects or substances (benzene, thinner, propane gas, alcohol, ether, LP gas, and other such products) in the refrigerator.
 - This refrigerator is for storing food only.
 - This may result in fire or explosion.
- Children should be supervised to ensure that they do not play with the appliance.
 - Keep fingers out of “pinch point” areas. Clearances between the doors and cabinet are necessarily small. Be careful when you open the doors if children are in the area.

Safety information

- Do not put your fingers or children's fingers between the doors.
 - Keep fingers out of the left and right door gaps. Be careful when you open the doors if your fingers are in between the doors.
- Do not let children hang on the door or door bins. A serious injury may occur.
- Do not let children go inside the refrigerator. They could become trapped.
- Do not insert your hands into the bottom area under the appliance.
 - Any sharp edges may cause personal injury.
- Do not store pharmaceutical products, scientific materials, or temperature sensitive products in the refrigerator.
 - Products that require strict temperature controls must not be stored in the refrigerator.
- If you smell pharmaceutical or smoke, pull out power plug immediately and contact your Samsung Electronics service center.
- If any dust or water is in Refrigerator, pull out power plug and contact your Samsung Electronics service center.
 - Otherwise there is a risk of fire.
- Do not let children step on a drawer.
 - The drawer may break and cause them to slip.
- Do not leave the doors of the refrigerator open while the refrigerator is unattended and do not let children enter inside the refrigerator.
- Do not allow babies or children go inside the drawer.
 - It can cause death from suffocation by entrapment or personal injury.

-
- Do not overfill the refrigerator with food.
 - When you open the door, an item may fall out and cause personal injury or material damage.
 - Do not spray volatile material such as insecticide onto the surface of the appliance.
 - As well as being harmful to humans, it may also result in an electric shock, fire, or problems with the product.
 - Never put fingers or other objects into the water dispenser hole, ice chute and ice maker bucket.
 - It may cause a personal injury or material damage.
 - Do not use or place any substances sensitive to temperature such as flammable sprays, flammable objects, dry ice, medicine, or chemicals near or inside of the refrigerator.
 - Do not use a hair dryer to dry the inside of the refrigerator. Do not place a lighted candle in the refrigerator for removing bad odours.
 - This may result in an electric shock or fire.
 - Fill the water tank, ice tray and water cubes only with potable water (mineral water or purified water).
 - Do not fill the tank with tea, juice or sports drink, this may damage the refrigerator.
 - Do not stand on top of the appliance or place objects (such as laundry, lighted candles, lighted cigarettes, dishes, chemicals, metal objects, etc.) on the appliance. This may result in an electric shock, fire, problems with the product, or injury. Do not put a container filled with water on the appliance.
 - If spilled, there is a risk of fire or electric shock.

Safety information

- Never stare directly at the UV LED lamp for long periods of time.
 - This may result in eye strain due to the ultraviolet rays.
- Do not put shelf in upside down. Shelf stopper could not work.
 - It may cause a personal injury because of glass shelf drop.
- Keep fingers out of “pinch point” areas. Clearances between the doors and cabinet are necessarily small. Be careful when you open the doors if children are in the area.
- If a gas leak is detected, avoid any naked flames or potential sources of ignition, and air the room in which the appliance is standing for several minutes.
 - Do not touch the appliance or power cord.
 - Do not use a ventilating fan.
 - A spark may result in explosion or fire.
- Bottles should be stored tightly together so that they do not fall out.
- This product is intended only for the storage of food in a domestic environment.
- Never put fingers or other objects into the water dispenser hole, ice chute and ice maker bucket.
 - It may cause a personal injury or material damage.
- Do not attempt to repair, disassemble, or modify the refrigerator yourself.
- Do not use any fuse (such as cooper, steel wire, etc.) other than a standard fuse.

-
- If your refrigerator needs to be repaired or reinstalled, contact your nearest service center.
 - Failing to do so may result in an electric shock, fire, problems with the product, or injury.
 - If the refrigerator emits a burning smell or smoke, unplug the refrigerator immediately and contact your Samsung Electronics service center.
 - Failing to do so may result in an electric or fire hazards.
 - Pull the power plug out of the socket before changing the interior lamps of the refrigerator.
 - Otherwise, there is a risk of electric shock.
 - If you experience difficulty changing a non-LED light, contact a Samsung service center.
 - Plug the power plug into the wall socket firmly.
 - Do not use a damaged power plug, damaged power cord or loose wall socket.
 - This may result in an electric shock or fire.

Safety information

Usage cautions

CAUTION

- Do not refreeze thawed food.
 - Frozen and thawed food will develop harmful bacteria faster than fresh.
 - The second thaw will break down even more cells, leaching out moisture and changing the integrity of the product.
- Do not thaw meat at room temperature.
 - Safety will depend on whether the raw product was handled properly.
- Do not place glass bottles or carbonated beverages into the freezer.
 - The container may freeze and break, and this may result in injury.
- Use only the ice maker provided with the refrigerator.
- If you will be away from home for a long period of time (on vacation, for example) and won't be using the water or ice dispensers, close the water valve.
 - Otherwise, water leakage may occur.
- If you won't be using the refrigerator for a very long period of time, (3 weeks or more) empty the refrigerator including the ice bucket, unplug it, close the water valve, wipe excess moisture from the inside walls, and leave the doors open to prevent odors and mold.
- To get the best performance from the product:
 - Do not place food too close to the vents at the rear of the refrigerator as this can obstruct free air circulation in the refrigerator compartment.

-
- Wrap food up properly or place it in airtight containers before putting it into the refrigerator.
 - Please observe maximum storage times and expiration dates of frozen goods.
 - There is no need to disconnect the refrigerator from the power supply if you will be away for less than three weeks. However, if you will be away for more than three weeks, remove all the food and ice in the ice bucket, unplug the refrigerator, close the water valve, wipe excess moisture from the inside walls, and leave the doors open to prevent odors and mold.
 - Service Warranty and Modification.
 - Any changes or modifications performed by a 3rd party on this finished appliance are not covered under Samsung warranty service, nor is Samsung responsible for safety issues that result from 3rd party modifications.
 - Do not block the air vents inside the refrigerator.
 - If the air vents are blocked, especially with a plastic bag, the refrigerator can be over cooled. If a cooling period lasts too long, the water filter may break and cause water leakage.
 - Use only the ice-maker provided with the refrigerator.
 - Wipe excess moisture from the inside and leave the doors open.
 - Otherwise, odor and mold may develop.
 - If the refrigerator is disconnected from the power supply, you should wait for at least five minutes before plugging it back in.

Safety information

- When the refrigerator got wet by water, pull out the power plug and contact your Samsung Electronics service center.
- Do not strike or apply excessive force to any glass surface.
 - Broken glass may result in a personal injury and/or property damage.
- Fill the water tank and ice cube trays with potable water only (tap water, mineral water, or purified water).
 - Do not fill the tank with tea or a sports drink. This may damage the refrigerator.
- Be careful that your fingers are not caught in.
- If the refrigerator is flooded, make sure to contact your nearest service center.
 - There is a risk of electric shock or fire.
- Do not keep vegetable oil in your refrigerator's door bins. The oil can solidify, making it foul-tasting and difficult to use. In addition, the open container can leak and the leaked oil can cause the door bin to crack. After opening an oil container, it is best to keep the container in a cool and shaded place such as a cupboard or pantry.
 - Examples of vegetable oil: olive oil, corn oil, grape-seed oil, etc.

Cleaning cautions

CAUTION

- Do not spray water directly on the inside or outside the refrigerator.
 - There is a risk of fire or electric shock.
- Do not use a hair dryer to dry the inside of the refrigerator.
- Do not place a lighted candle in the refrigerator to remove bad odors.
 - This may result in an electric shock or fire.
- Do not spray cleaning products directly on the display.
 - Printed letters on the display may come off.
- If any foreign substance such as water has entered the appliance, unplug the power plug and contact your nearest service center.
 - Failing to do so may result in an electric shock or fire.
- Use a clean, dry cloth to remove any foreign matter or dust from the power plug blades. Do not use a wet or damp cloth when cleaning the plug.
 - Otherwise, there is a risk of fire or electric shock.
- Do not clean the appliance by spraying water directly onto it.
- Do not use benzene, thinner, or Clorox, Chloride for cleaning.
 - They may damage the surface of the appliance and may cause a fire.
- Never put fingers or other objects into the dispenser hole.
 - It may cause a personal injury or material damage.

Safety information

- Before cleaning or performing maintenance, unplug the appliance from the wall socket.
 - Failing to do so may result in an electric shock or fire.
- Use a clean sponge or soft cloth and a mild detergent in warm water to clean the refrigerator.
- Do not use abrasive or harsh cleansers such as window sprays, scouring cleansers, flammable fluids, muriatic acid, cleaning waxes, concentrated detergents, bleaches, or cleansers containing petroleum products on exterior surfaces (doors and cabinet), plastic parts, door and interior liners, and gaskets.
 - These can scratch or damage the material.
- Do not clean glass shelves or covers with warm water when they are cold. Glass shelves and covers may break if exposed to sudden temperature changes or impacts such as bumping or dropping.



Critical disposal warnings

WARNING

- Please dispose of the packaging material from this product in an environmentally friendly manner.
- Ensure that none of the pipes on the back of the refrigerator are damaged prior to disposal.
- R-600a or R-134a is used as a refrigerant. Check the compressor label on the rear of the appliance or the rating label inside the fridge to see which refrigerant is used for your refrigerator. If this refrigerator contains flammable gas (Refrigerant R-600a), contact your local authority in regard to safe disposal of this product.
- When disposing of this refrigerator, remove the door/door seals and door latch so that small children or animals cannot become trapped inside. Children should be supervised to ensure that they do not play with the appliance. If trapped inside, a child may get hurt or suffocate to death.
 - If trapped inside, the child may become injury and suffocate to death.
- Cyclopentane is used in the insulation. The gases in the insulation material require a special disposal procedure. Please contact your local authorities in regard to the environmentally safe disposal of this product.
- Keep all packaging materials well out of the reach of children, as packaging materials can be dangerous to children.
 - If a child places a bag over his or her head, the child could suffocate.



Safety information

Additional tips for proper usage

- In the event of a power failure, call the local office of your electric company and ask how long the failure is going to last.
 - Most power failures that are corrected in an hour or two will not affect your refrigerator temperatures. However, you should minimize the number of door openings while the power is off.
 - Should the power failure last more than 24 hours, remove and discard all frozen food.
- The refrigerator might not operate consistently (frozen contents can thaw or temperatures can become too warm in the frozen food compartment) if sited for an extended period of time in a location where ambient air temperatures are constantly below the temperatures for which the appliance is designed.
- In case of particular foods, keeping it under refrigeration can have a bad effect on preservation due to its properties.
- Your appliance is frost free, which means there is no need to manually defrost your appliance. This will be carried out automatically.
- Temperature rise during defrosting complies with ISO requirements. If you want to prevent an undue rise in the temperature of frozen food while the appliance defrosts, wrap the frozen food in several layers of newspaper.
- Do not re-freeze frozen foods that have thawed completely.

Instructions about the WEEE



Correct Disposal of This Product (Waste Electrical & Electronic Equipment) (Applicable in countries with separate collection systems)

This marking on the product, accessories or literature indicates that the product and its electronic accessories (e.g. charger, headset, USB cable) should not be disposed of with other household waste at the end of their working life. To prevent possible harm to the environment or human health from uncontrolled waste disposal, please separate these items from other types of waste and recycle them responsibly to promote the sustainable reuse of material resources.

Household users should contact either the retailer where they purchased this product, or their local government office, for details of where and how they can take these items for environmentally safe recycling.

Business users should contact their supplier and check the terms and conditions of the purchase contract. This product and its electronic accessories should not be mixed with other commercial wastes for disposal.

For information on Samsung's environmental commitments and product regulatory obligations, e.g. REACH, WEEE or Batteries, visit our sustainability page available via www.samsung.com

(For products sold in European countries and in the UK only)

Installation

Follow these instructions carefully to ensure a proper installation of this refrigerator and to prevent accidents before using it.

⚠ WARNING

- Use the refrigerator only for its intended purpose as described in this manual.
- Any servicing must be performed by a qualified technician.
- Dispose of the product packaging material in compliance with the local regulations.
- To prevent electric shock, unplug the power cord before servicing or replacements.

Refrigerator at a glance

The actual image and provided parts of the refrigerator may differ, depending on the model and the country.

Normal type

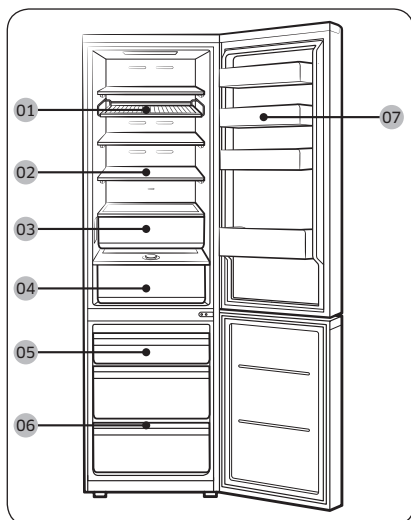

Dispenser type

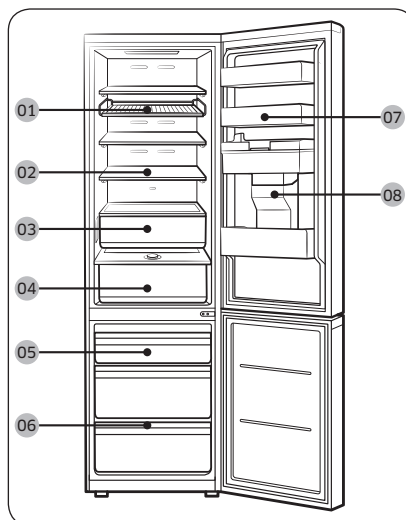

01 Rack & Shelf *

02 Fridge shelf /
Foldable shelf *

03 Optimal Fresh+ *

04 Humidity Fresh* /
Humidity Fresh+ *

05 Freezer box

06 Freezer shelf *

07 Fridge door bin

08 Water tank **

* applicable models only

** dispenser type models only

 **NOTE**

- For best energy efficiency, make sure all of shelves, drawers, and baskets are placed in their original position.
- To get more space, you can remove all the drawers and locate the 'Freezer Shelf (applicable models only)' on the bottom drawer in freezer, since it does not affect thermal and mechanical characteristics. A declared storage volume of frozen food storage compartment is calculated with these drawers removed.
- An alarm sounds if the freezer door is opened wider than 4° for longer than 2 minutes. Close the freezer door when you hear an alarm. (RB38A*B*A***, RB38A*B*B***, RB38A*B*3*** models only)

Step-by-step installation

STEP 1 Select a site

Site requirements:

- Solid, level surface without carpeting or flooring that may obstruct ventilation
- Away from direct sunlight
- Adequate room for opening and closing the door
- Away from a heat source
- Room for maintenance and servicing
- Temperature range: between 10 °C and 43 °C

Installation

Clearance

See the following figures and tables for space requirements for installation.

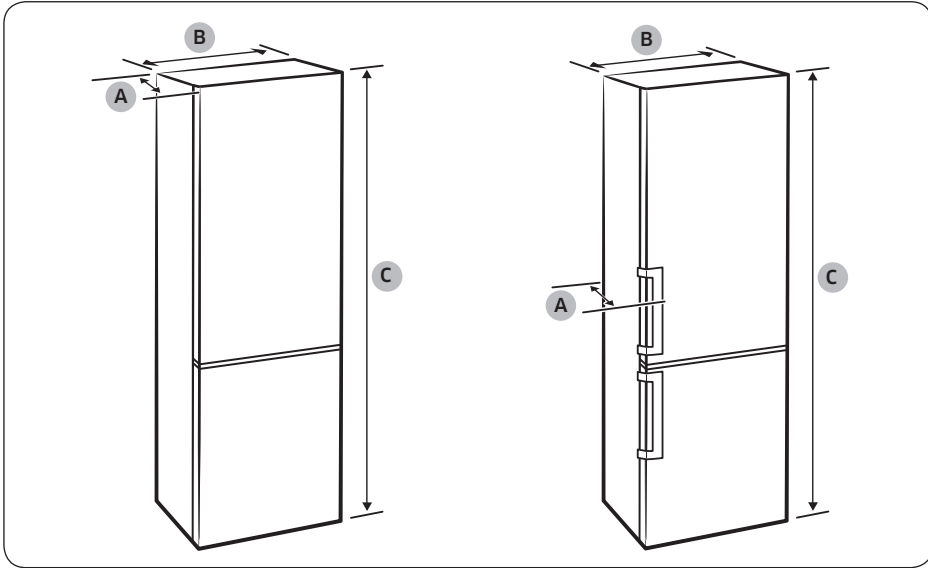

Installation

Model	Recess handle type			Bar handle type			Bespoke type	
	RB34T* RB3CT* RL34T* RB33B*	RB36T* RB3DT* RL36T*	RB38T* RB3ET* RL38T*	RB34T* RB3CT* RL34T*	RB36T* RB3DT* RL36T*	RB38T* RB3ET* RL38T*	RB34A* RL34A*	RB38A* RL38A*
Depth "A"	658			720			658	
Width "B"	595			595			595	
Overall Height "C"	1853	1935	2030	1853	1935	2030	1853	2030

(unit : mm)

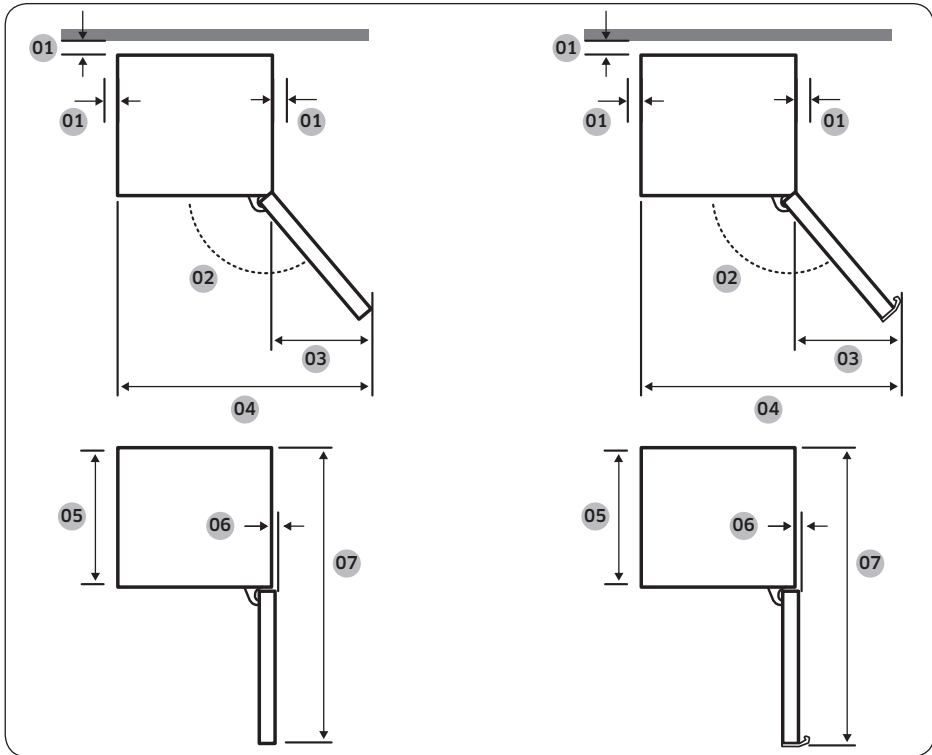

Installation

Model	Recess handle type	Bar handle type	Bespoke type
01	more than 50 mm recommended	more than 50 mm recommended	more than 50 mm recommended
02	135°	135°	105°
03	404	433	191
04	999	1028	786
05	595	595	595
06	6	6	0
07	1210	1217.5	1207

(unit : mm)

NOTE

The measurements in the table may differ, depending on the measuring method.

Installation

STEP 2 Spacing (applicable models only)

NOTE

The number of provided spacers varies on the model. Attach all the provided spacers.

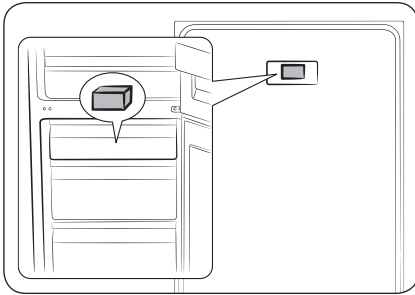

1. Open the door and locate the provided spacer (Gray block).
2. Unpack the spacer and attach it to the rear of the refrigerator as shown. They help ventilate air to the rear wall and save power consumption.

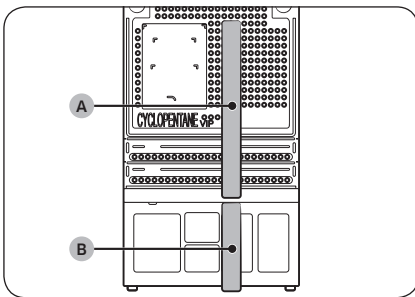

3. Attach the provided spacer (A, sponge) and the spacer (B, sponge) as shown in the figure for optimal energy efficiency.

CAUTION

- If the refrigerator is not flush with the cabinet, you may cut the spacers to make the refrigerator flush with the cabinet, but the optimal energy efficiency cannot be guaranteed.
- Make sure the attached spacer(s) contact the wall when you put the refrigerator into the installation site.

STEP 3 Flooring

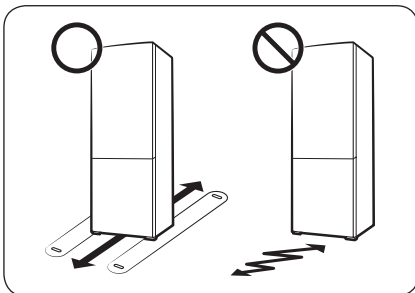

- The surface to install the refrigerator must support a fully loaded refrigerator.
- To protect the floor, put a large piece of cardboard on each foot of the refrigerator.
- Once the refrigerator is in its final position, do not move it unless necessary to protect the floor. If you have to, use a thick paper or cloth such as old carpet along the movement path.

STEP 4 Adjust the levelling legs

⚠ CAUTION

- The refrigerator must be levelled on a flat, solid floor. Failing to do so can cause damage to the refrigerator or physical injury.
- Levelling must be performed with an empty refrigerator. Make sure no food items remain inside the refrigerator.
- For safety reasons, adjust the front side a little higher than the rear side.

The refrigerator can be levelled using the front legs that have a special screw (leveller) for levelling purposes. Use a flat-head screwdriver for levelling.

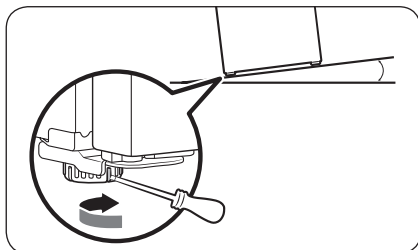

To adjust the height of the left side:

Insert a flat-head screwdriver into the leveller of the front left leg. Turn the leveller clockwise to raise, or turn it anticlockwise to lower.

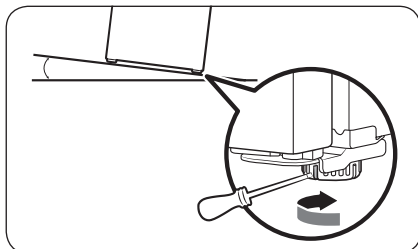

To adjust the height of the right side:

Insert a flat-head screwdriver into the leveller of the front right leg. Turn the leveller clockwise to raise, or turn it anticlockwise to lower.

Installation

STEP 5 Initial settings

By completing the following steps, the refrigerator should be fully functioning.

1. Remove the PE foam sheet on each shelf corner, which is attached to protect the refrigerator during transportation.
2. Plug the power cord into the wall socket to turn the refrigerator on.
3. Open the door, and check if the interior light lights up.
4. Set the temperature to the coldest, and wait for about an hour. Then, the refrigerator will be slightly chilled, and the motor will run smoothly.
5. Wait until the refrigerator reaches the set temperature. Now the refrigerator is ready for use.

NOTE

When the refrigerator powers on, the alarm will sound. To turn off the alarm, tap <, ○ or >.

STEP 6 Temperature Alarm (applicable models only)

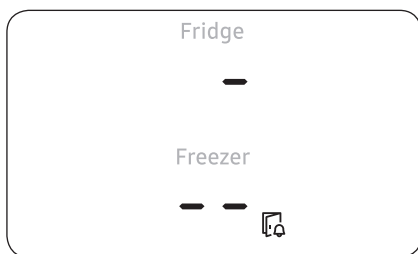

- If the freezer temperature is too warm because there has been a power failure, the display blinks as shown in the figure.
 - If you tap any button (<, ○, or >), the "warmest temperature" which has reached in the freezer and fridge compartment is flashed on the display for 5 seconds.
- This warning may occur;
 - When the appliance is turned on for the first time after the installation.
 - If the freezer is too warm due to a power failure.

STEP 7 Final check

When installation is complete, confirm that:

- The refrigerator is plugged into an electrical outlet and grounded properly.
- The refrigerator is installed on a flat, level surface with a reasonable clearance from the wall or the cabinet.
- The refrigerator is level and is sitting firmly on the floor.
- The door opens and closes freely, and the interior light turns on automatically when you open the door.

Operations

Control panel (applicable models only)

Button type

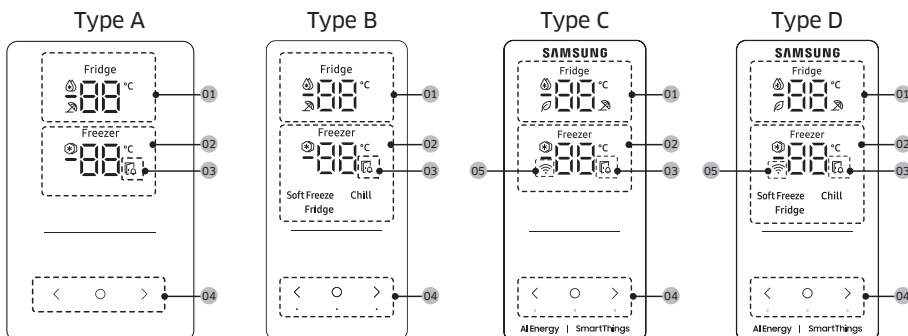

01 Fridge indicator	<ul style="list-style-type: none"> Displays the current or desired temperature of the fridge. ☁ indicates that the Power Cool function is on. ⌘ indicates that the Vacation function is on. The ρ icon appears if you turn on the AI saving mode in the SmartThings app. (applicable models only)
02 Freezer indicator	<ul style="list-style-type: none"> Displays the current or desired temperature of the freezer. ❄ indicates that the Power Freeze function is on.
03 Door open indicator	This indicator blinks with an alarm if the door is left open for more than 2 minutes.
04 Buttons	<ul style="list-style-type: none"> When the display is off, tap any button to wake up the display. Use ○ to select the fridge or freezer and < or > to select the desired temperature or function for the selected compartment.
05 Network connection indicator	<ul style="list-style-type: none"> This icon indicates that the refrigerator is connected to a network. If the Wi-Fi icon flashes, we recommend connecting your refrigerator with the SmartThings app. You can control and monitor your refrigerator on the SmartThings app. For more information, see the SmartThings (applicable models only) section.

NOTE

- The control panel is designed to stay off when the refrigerator is not in use. It only becomes active and lights up when you open the door or tap the buttons.

Operations



- If the door is left open for 5 minutes, internal light will blink for 5 minutes and turn off. This is to alert hearing-impaired users that a door is open. Note that this function is normal.

Setting the desired temperature or function

1. Tap any button (<, ○, or >) to wake up the display.
 - This step may not apply to some models.
2. Tap ○ to select the fridge or freezer.
 - The selected compartment's indicator blinks.
 - The degrees Celsius symbol (°C) does not blink.
3. Tap < or > to select the desired temperature or function.
 - Refer to the table for available selection for each compartment.

Fridge	<ul style="list-style-type: none">• Available selection: 🔥 (Power Cool) ↔ 1 °C ↔ 2 °C ↔ 3 °C ↔ 4 °C ↔ 5 °C ↔ 6 °C ↔ 7 °C ↔ ❄️ (Vacation)• Power Cool speeds up the cooling process at maximum fan speed. The fridge keeps running at full speed for two and a half hours and then returns to the previous temperature.• Use the Vacation function if you are going on vacation or a business trip, or if you do not intend to use the fridge for an extended time. The fridge temperature will be kept under 17 °C, but the freezer remains active as previously set.
--------	---



Freezer	<ul style="list-style-type: none"> • Available selection: [Type A, C]:  (Power Freeze) ↔ -23 °C ↔ -22 °C ↔ -21 °C ↔ -20 °C ↔ -19 °C ↔ -18 °C ↔ -17 °C ↔ -16 °C ↔ -15 °C [Type B, D]:  (Power Freeze) ↔ -23 °C ↔ -22 °C ↔ -21 °C ↔ -20 °C ↔ -19 °C ↔ -18 °C ↔ -17 °C ↔ -16 °C ↔ -15 °C ↔ Soft Freeze (-5 °C) ↔ Chill (-1 °C) ↔ Fridge (2 °C) • Power Freeze speeds up the freezing process at maximum fan speed. The freezer keeps running at full speed for 50 hours and then returns to the previous temperature. To freeze large amounts of food, activate Power Freeze for at least 20 hours before putting food in the freezer. • Freezer modes descriptions (For Type B, D only) <ul style="list-style-type: none"> - Soft Freeze (-5 °C): For storing frozen fish and meat before properly defrosting. - Chill (-1 °C): Ideal for storing meats and fresh seafood. - Fridge (2 °C): For preserving fruit and vegetables. • ⚠ CAUTION (For Type B, D only) <ul style="list-style-type: none"> • If you set the Freezer mode to Soft Freeze, Chill, or Fridge, the freezer temperature will rise, and the stored food may leak juice as they begin to thaw. • Do not store meat or fish for an extended time in Soft Freeze or Chill mode. They may spoil as the temperature in those modes is not appropriate for storing meat or fish for a long time. • 📄 NOTE When you use this function the energy consumption of the refrigerator will increase. Remember to turn it off when you don't need it and return the freezer to your original temperature setting.
---------	--

4. Wait until the selected compartment's indicator stops blinking or tap  to confirm your selection.

 NOTE

Using Power Cool or Power Freeze increases power consumption.



Operations

Turning on or off the Wi-Fi (applicable models only)

To turn the Wi-Fi on or off, tap and hold > for 10 seconds. The display shows the status of Wi-Fi for 5 seconds (as shown in the figure).

Wi-Fi On

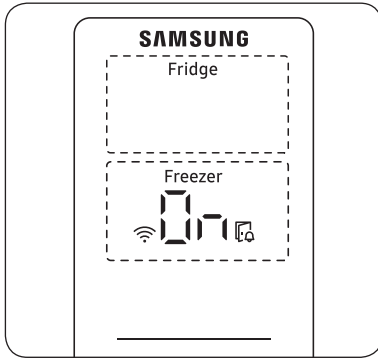

Wi-Fi Off

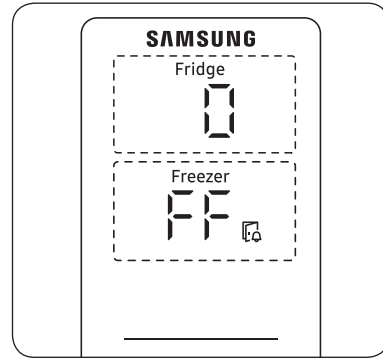

NOTE

- When you setup the Wi-Fi to connect the refrigerator to the SmartThings app, Wi-Fi On/Off functions turns on.
- For more information, see the **SmartThings (applicable models only)** section.

Dial type

Fridge / Freezer

To ensure optimal performance, we recommend setting the temperature to "3".

Use the Fridge/Freezer Control dial to select the desired preset temperature for the fridge and freezer. Refer to the table below the dial for the preset temperature of each level.

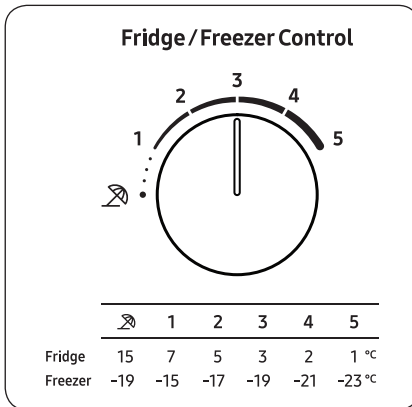

- To decrease the temperature for strong cooling, set the temperature control to level 4-5.
- To increase the temperature for weak cooling, set the temperature control to level 1-2.

⚠ CAUTION

- In winter, do not set the temperature control to level 4-5. This may cause problems with the cooling performance.
- In summer, do not set the temperature control to level 1-2. This may also cause problems with the cooling performance.

Operations

Vacation

If you are going on vacation or a business trip, or if you do not intend to use the fridge for an extended time, use the Vacation mode.

Fridge/Freezer Control

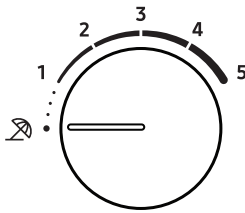

		1	2	3	4	5
Fridge	15	7	5	3	2	1 °C
Freezer	-19	-15	-17	-19	-21	-23 °C

To activate the Vacation mode, turn the Fridge/Freezer Control dial to . The fridge temperature will be controlled under 15 °C and the freezer temperature will be controlled under -19 °C.

NOTE

It is strongly recommended to empty the fridge compartment and make sure the door is closed.

SmartThings (applicable models only)

Installation

Visit the Google Play Store, Galaxy Apps, or Apple App Store and search for “SmartThings”. Download and install the SmartThings app provided by Samsung Electronics to your smart device.

NOTE

- The supporting software version of the SmartThings app is subject to change according to the OS supporting policy the manufacturer provides. In addition, as for the SmartThings app or the functions that the app supports, the new application update policy on the existing OS version can be suspended due to usability or security reasons.
- The SmartThings app is subject to change without notice to improve usability or performance. As the mobile phone OS version is updated every year, the SmartThings is also updated continually according to the latest OS. If you have enquiries regarding the items mentioned above, please contact us on st.service@samsung.com
- Recommended encryption systems include WPA/TKIP and WPA2/AES. Any newer or non-standard Wi-Fi authentication protocols are not supported.
- Wireless networks may be affected by the surrounding wireless communication environment.
- If your Internet service provider has registered the MAC address of your PC or modem for identification, your Samsung Smart Refrigerator may fail to connect to the Internet. If this happens, contact your Internet service provider for technical assistance.
- The firewall settings of your network system may prevent your Samsung Smart Refrigerator from accessing the Internet. Contact your Internet service provider for technical assistance. If this symptom continues, contact a local Samsung service center or retailer.
- To configure the wireless access point (AP) settings, see the user manual of the AP (router).
- Samsung Smart Refrigerators support both Wi-Fi 2.4 GHz with IEEE 802.11 b/g/n and Soft-AP protocols. (IEEE 802.11 n is recommended.)
- Unauthorized Wi-Fi wireless routers may fail to connect to applicable Samsung Smart Refrigerators.

Operations

Samsung account

You are required to register your Samsung account to use the app. If you don't have a Samsung account, follow the app's onscreen instructions to create a free Samsung account.

Getting started

Turn on the device you want to connect, open the SmartThings app on your phone, and then follow the instructions below.

If a pop-up appears saying that a new device has been found, tap **ADD NOW**.

If a pop-up doesn't appear, tap the **+** button, and then select the device you want to connect from the list of available devices.

If your device isn't in the list of available devices, tap **Supported Devices**, select the device type (Refrigerator), and then select the specific device model.

Follow the instructions in the app to set up your device. Once setup is complete, your refrigerator will appear as a "card" on your **Devices** screen.

Refrigerator app

Integrated control

You can monitor and control your refrigerator at home and on the go.

- Tap the refrigerator icon on the SmartThings Dashboard or tap the Devices icon at the bottom of the Dashboard, and then tap the refrigerator "card" to open the Refrigerator page.
- Check the operation status or notifications related to your refrigerator, and then change options or settings if necessary.

NOTE

Some options or settings of the refrigerator may not be available for remote control.

Category	Item	Description
Monitoring	Fridge temperature	Displays the current temperature setting of the fridge.
	Freezer temperature	Displays the current temperature setting of the freezer.
	Energy monitoring	Checks the accumulated power consumption of the refrigerator for the last 180 days.
Functions	Power Cool	You can turn Power Cool on or off, and check the current settings.
	Power Freeze	You can turn Power Freeze on or off, and check the current settings.
Alarms	Abnormally high temperature	This alarm is triggered when the fridge or freezer has abnormally high temperatures.
	Door opening	This alarm is triggered if the fridge or freezer door is open for more than 2 minutes.
AI saving mode (applicable models only)	<p>You can turn on or off the AI saving mode under the Energy menu in the SmartThings app.</p> <p>You can check the status of the AI saving mode on the SmartThings app.</p> <p>On some models, the  icon appears on the control panel to indicate that AI saving mode is on. (applicable models only)</p> <p>Turning on the AI Saving mode decreases energy consumption, but it may also reduce the cooling performance.</p>	

Operations

Special features

The actual image and special functions of your refrigerator may differ, depending on the model and the country.

Water dispenser (applicable models only)

With the water dispenser, you can dispense water without opening the fridge door. The water tank must be filled with potable water before use.

To fill the water tank with potable water

Open the door and locate the water tank that is located in the door shelf area.

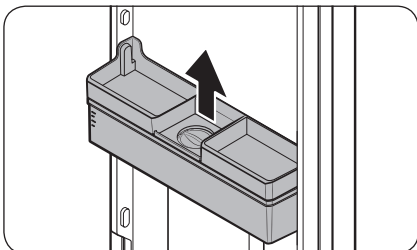

1. Hold the handgrips on both sides of the water tank and lift up to remove.

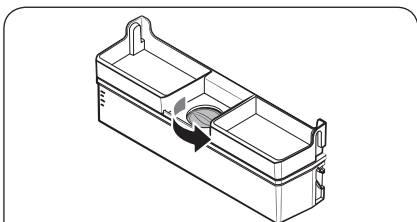

2. Fill the water tank with potable water up to 3.5 liters (MAX). You can remove either the top cap or the cover and pour water.

⚠ CAUTION

- The water dispenser is designed to dispense potable water. Fill the water tank only with potable water. Do not fill with any other liquids.
- Do not fill the water tank excessively, which causes an overflow.

📖 NOTE

For first-time use, clean inside the water tank.

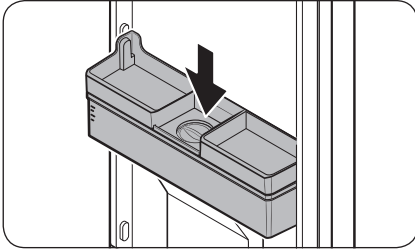

3. Reinsert the water tank and close the door. Make sure the water outlet of the water tank faces forward.

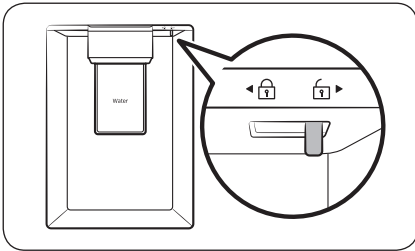

4. Put a water glass under the water outlet of the dispenser, and gently push the dispenser lever to dispense water. Make sure the water dispenser is unlocked.

⚠ CAUTION

- Do not store items on top of the water tank cap.
- Do not try to fill the water tank without removing it from the door.
- Make sure that water tank is seated properly.
- Do not use the refrigerator without the water tank. This may reduce performance and efficiency.
- To prevent water bouncing, make sure the glass is in line with the dispenser lever.

📄 NOTE

To secure more room, you can use the water tank to store food. In this case, remove the lid of the tank.

Operations

Optimal Fresh+ (applicable models only)

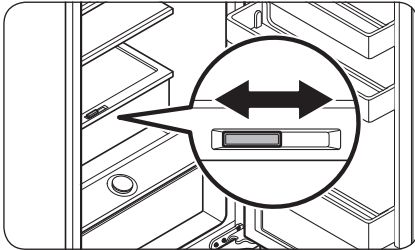

Optimal Fresh+ drawer allows you to divide the area into two separated zones using the Flex Divider.

Store meat and fish on the left side of Optimal Fresh+ and vegetables and fruits on the right side.

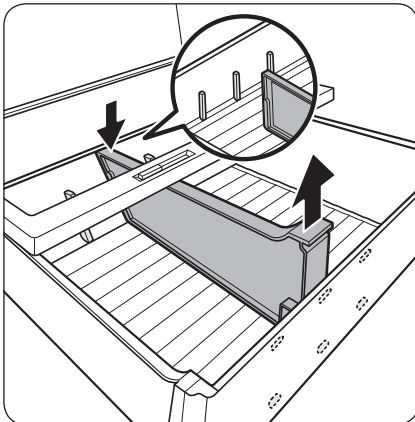

Removing the Flex Divider

While pressing the rear side, pull up the front side to remove.

Humidity Fresh+ (applicable models only)

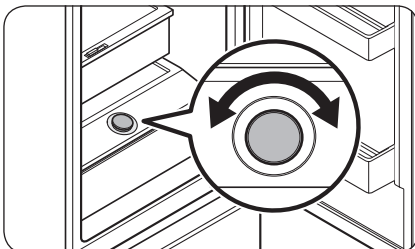

Humidity Fresh+ allows you to adjust the humidity. Turn the control dial left or right to adjust the humidity as you desire.

Using the freezer shelf (applicable models only)

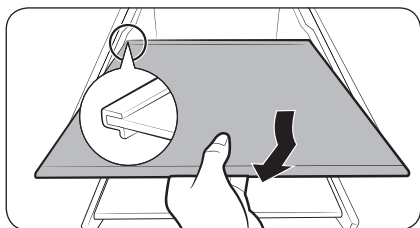
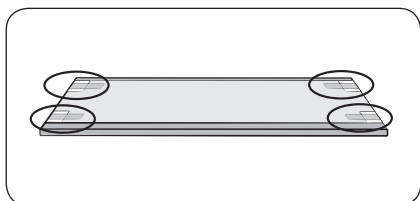
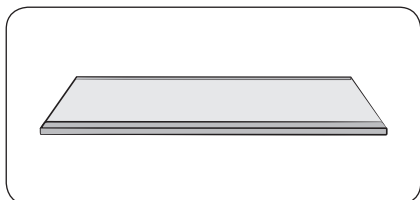

To get more space, you can remove all the drawers and locate the 'Freezer Shelf' on the bottom drawer, since it does not affect thermal and mechanical characteristics.

A declared storage volume of frozen food storage compartment is calculated with these drawers removed.

(In the case of Singapore model, declared volume is calculated with taking out the upper & middle drawer only.)

1. Remove the tape attached on the shelf.
2. Take out all the drawers to assemble the shelf.
3. Insert the shelf. Insert the protruding part of the shelf first as shown in the figure.

⚠ CAUTION

- Do not insert the shelf upside-down, or in the reverse direction.
- When you don't use the freezer shelf, keep it safe for later use.

📖 NOTE

When storage the glass container on the tempered shelf, the scratch may occur since friction on the shelf.

Maintenance

Reversing the door handle position (For models with bar handles)

NOTE

This procedure applies to both the fridge and freezer compartment.

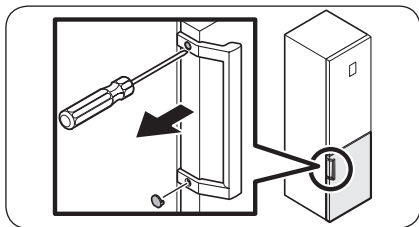

1. Use a flat-head screwdriver to remove the screw covers.
 - After detaching the handle, attach the screw covers back on the screw holes.

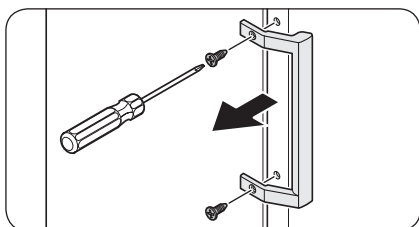

2. Use a Phillips screwdriver to remove the screws and detach the handle.

NOTE

Use these screws to fasten the handle on the opposite side.

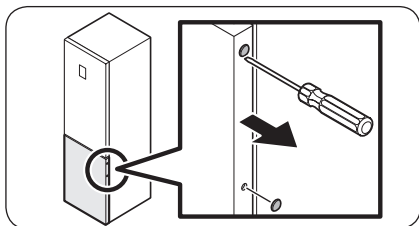

3. On the opposite side of the door, use a flat-head screwdriver to remove the screw covers.

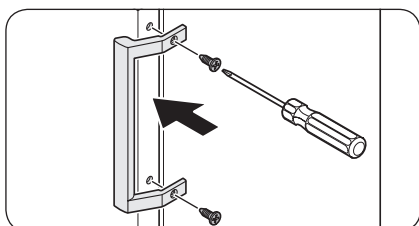

4. Place the handle on the opposite side of the door and use a Phillips screwdriver to attach the handle with the screws.

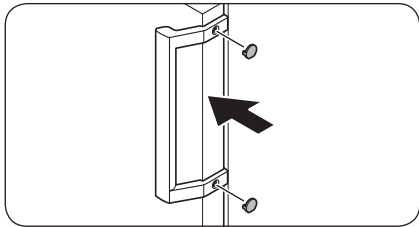

5. Attach the screw covers.

Door reversal (applicable models only)

⚠ WARNING

- Tilting/laying the refrigerator requires a minimum of 2 people.
- Disconnect the power cord before reversing the doors.

Tools required (not provided)

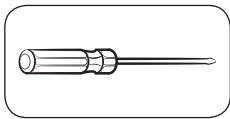

Phillips screwdriver

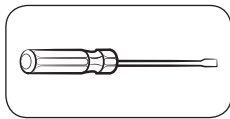

Flat-head screwdriver

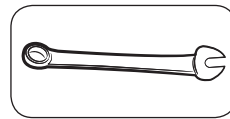

11 mm spanner

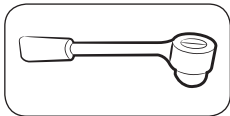

10 mm socket wrench

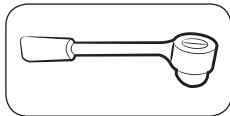

8 mm socket wrench



10 mm spanner

Maintenance



Maintenance

Accessories

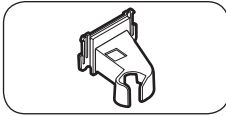

Top-left hinge cover

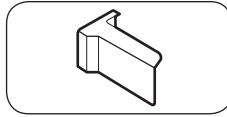

Top-right door cover
(applicable models only)

⚠ CAUTION

- Be careful not to damage the wires and connectors during this process.
- Throughout the entire reversing procedure, keep all the small parts (screws, caps, etc.) of the refrigerator away from children or infants for safety reasons.
- Make sure to keep all the screws and other removed parts in a safe place during the door reversal process.

📖 NOTE

- Samsung recommends that reversing of the door opening is only completed by Samsung approved service providers. This will be on a chargeable basis at the customer's expense.
- Before reversing the doors, put a protective material (such as a cardboard box) on the floor where you can safely place the removed parts, preventing any damage throughout the whole process.

Reversing the door

📖 NOTE

For the models with handles, reverse the handles first. (For detailed information, see the "Reversing the door handle position (For models with bar handles)" section.)

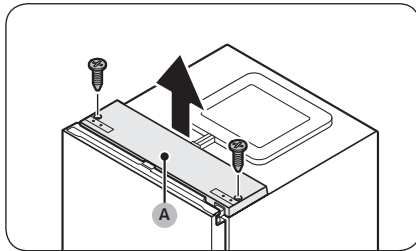

1. With the fridge door closed, use a Phillips screwdriver to remove the screws fastening the top cover (A).

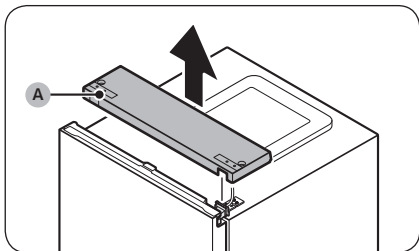

2. Gently lift the **top cover (A)** and place it on top of the refrigerator.
 - Be careful when you lift the **top cover (A)**. There is a wire connected underneath it.

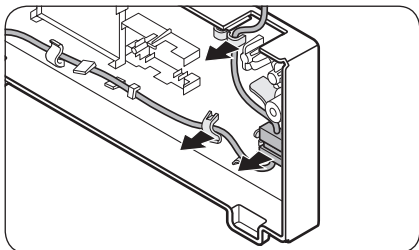

3. Remove the wire and the wire connector placed on the holder underneath the top cover.
 - This step may not apply to some models.

⚠ CAUTION

Do not pull the connectors too hard.

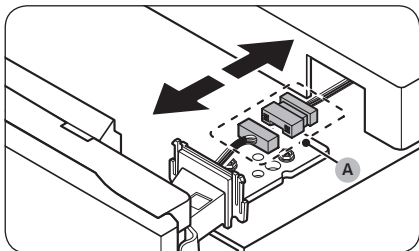

4. Disconnect the **wire connector (A)**.
 - This step may not apply to some models.

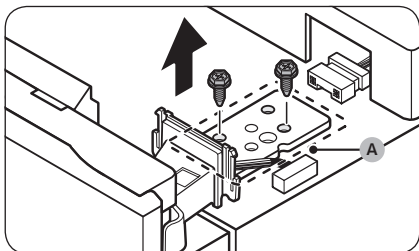

5. Use a socket wrench (8 mm) to remove the screws fastening the **top hinge (A)**.

⚠ CAUTION

To prevent the fridge door from falling, make sure to hold it tight while removing the screws.

📌 NOTE

You can also use a Phillips screwdriver to remove the screws.

Maintenance

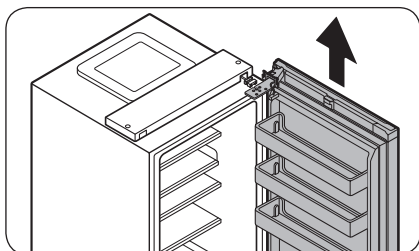

6. Open the fridge door, and then lift the door to remove it from the middle hinge. Keep the door in a safe place.

⚠ CAUTION

The door is heavy. To prevent damage or injury, use caution while removing the door.

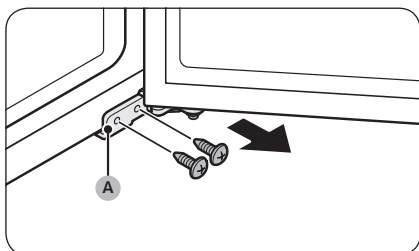

7. Open the freezer door, and then use a Phillips screwdriver to remove the screws fastening the **bottom hinge (A)**.

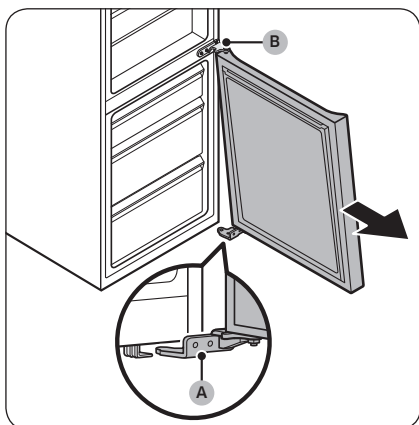

8. With the freezer door sitting on the **bottom hinge (A)**, slowly pull the **bottom hinge (A)** to remove it from the holder on the bottom of the refrigerator. Once the **bottom hinge (A)** is removed from the freezer door, and then pull the freezer door down to remove it from the **middle hinge (B)**.

⚠ CAUTION

To prevent the freezer door from falling, make sure to hold the freezer door tight until it is safely removed from the **middle hinge (B)**.

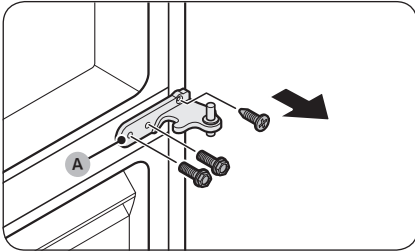

9. Use a Phillips screwdriver and socket wrench (10 mm) to remove the screws fastening the **middle hinge (A)**.

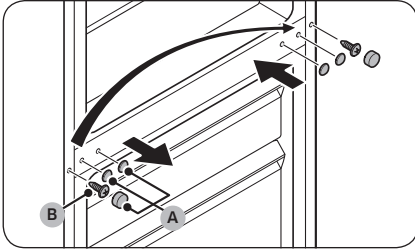

10. Remove the **middle hinge screw covers (A)**, and then use a Phillips screwdriver to remove the **screw (B)**.

11. On the opposite side, use a Phillips screwdriver to fasten the **screw (B)**, and then put on the **middle hinge screw covers (A)**.

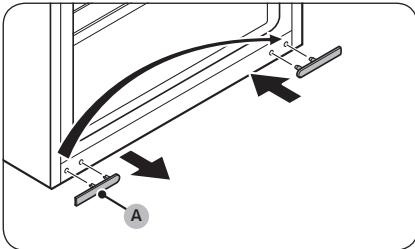

12. Remove the **bottom hinge screw cover (A)** and put it on the opposite side.

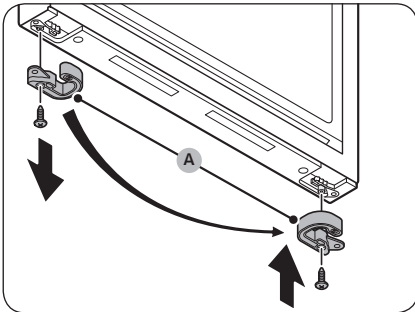

13. On the bottom of the freezer door, remove the **door stopper (A)** and put it on the opposite side of the door.
 - Use a Phillips screwdriver to remove and tighten the screw fastening the **door stopper (A)**.
 - Flip the **door stopper (A)** before putting it on the opposite side.

Maintenance

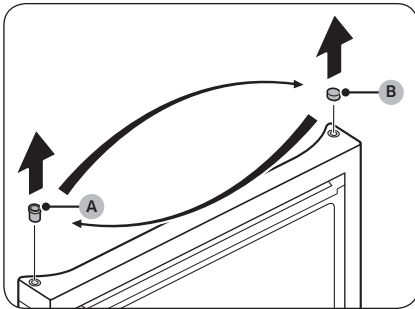

14. On the top of the freezer door, switch the position of the **grommet (A)** and the **grommet cover (B)**.

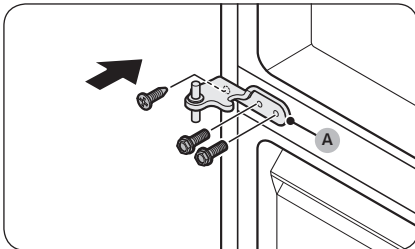

15. Fasten the **middle hinge (A)** to the opposite side of where it was removed.
 - Use a Phillips screwdriver and socket wrench (10 mm) to fasten the screws.

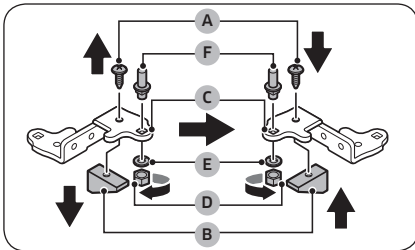

16. Disassemble the bottom hinge and reverse all the parts.
 - a. Use a Phillips screwdriver to remove the **screw (A)** fastening the **fixer (B)** to the **bottom hinge (C)**.
 - b. Use a spanner (10 mm) to remove the **nut (D)** and **washer (E)** fastening the **shaft (F)**.
 - c. Flip the **bottom hinge (C)**, and then reattach the **shaft (F)** with the **washer (E)** and the **nut (D)**.
 - d. Fasten the **fixer (B)** with the **screw (A)**.

⚠ CAUTION

- Be careful not to drop the **shaft (F)** or hurt your fingers when removing or assembling the **shaft (F)**.
- Make sure the **washer (E)** is in the correct place. If the shaft is fastened without the **washer (E)**, the freezer door may fall and cause injury.

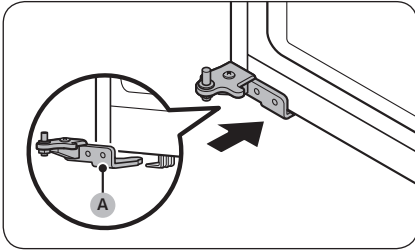

17. Turn the levelling leg on the opposite side of where **bottom hinge (A)** removed. Then, Put the **bottom hinge (A)** on the holder.

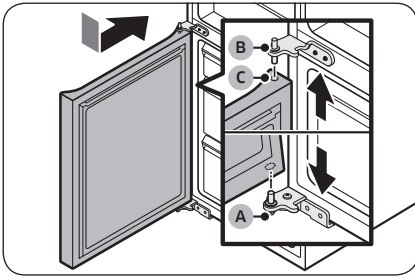

18. Attach the freezer door.
- Put the freezer door on the **bottom hinge (A)**. Place the door perpendicular to the refrigerator's main body.
 - Push the freezer door down to insert the **middle hinge (B)** into the **grommet (C)** on top of the freezer door.

CAUTION

Do not push the door too hard. Make sure the **bottom hinge (A)** stays on the holder at the bottom of the refrigerator throughout this step.

NOTE

After attaching the freezer door, adjust the levelling legs to level the refrigerator. (For detailed instruction, see the "STEP 4 Adjust the levelling legs" section on page 33.)

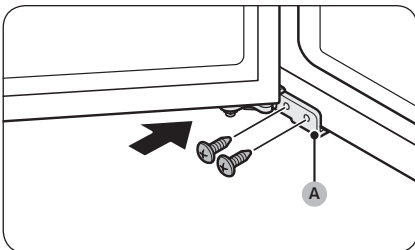

19. Use a Phillips screwdriver to fasten the **bottom hinge (A)** with the screws. Then, close the freezer door.

Maintenance

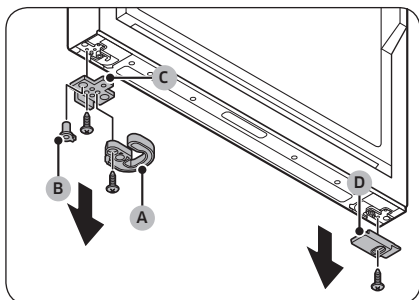

20. On the bottom of the fridge door, remove all the part on the left and right side.

- a. Use a Phillips screwdriver to remove the screws.
- b. Remove the **auto closer (A)**, **grommet (B)**, and **door stopper (C)** on one side, and the **bottom fridge door cover (D)** on the other side.

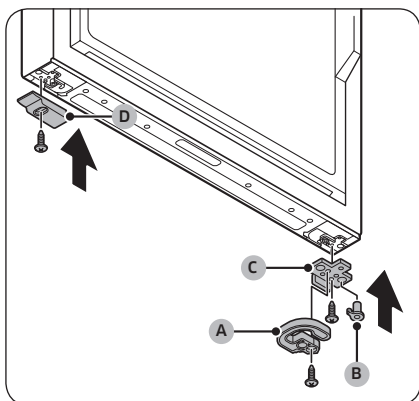

21. Switch the sides of all the removed parts.

- a. Put the **door stopper (C)**, **grommet (B)**, **auto closer (A)** on the opposite side to where they were removed.
- b. Fasten the **door stopper (C)** and **auto closer (A)** with the screws using a Phillips screwdriver.
- c. Put the **bottom fridge door cover (D)** on the opposite side to where it was removed.
- d. Fasten the **bottom fridge door cover (D)** with the screw using a Phillips screwdriver.

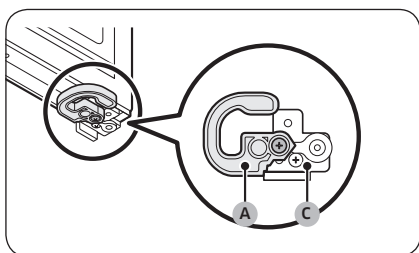

⚠ CAUTION

You must fasten the screws for the **door stopper (C)** and **auto closer (A)** correctly as shown in the figure. If you fasten the the screws incorrectly, it causes the door hinge damage.

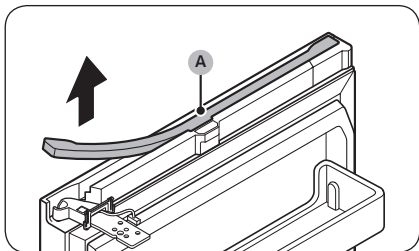

22. On the top of the fridge door, remove the **wire cover (A)**.

- Gently lift either side of the **wire cover (A)** and pull to remove it from the door.
- This step may not apply to some models.

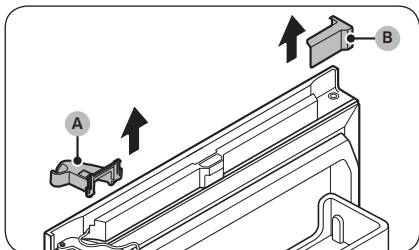

23. Remove the **top-right hinge cover (A)** and the **top-left door cover (B)**.

- This step may not apply to some models.

NOTE

Keep the removed parts in a safe place for later use.

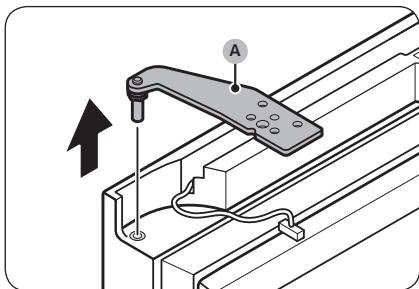

24. Remove the **top hinge (A)** from the fridge door.

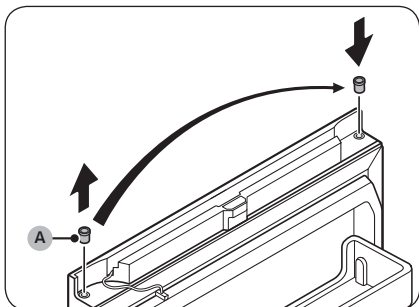

25. Remove the **grommet (A)** and put it on the opposite side.

Maintenance

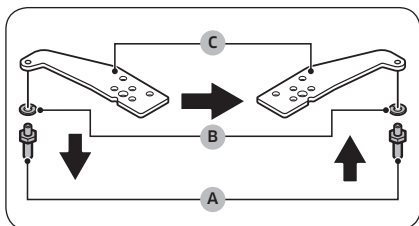

26. Reverse the top hinge.

- a. Use a spanner (11 mm) to disassemble the **shaft (A)** and **washer (B)**.
- b. Flip the **top hinge (C)**, and then reattach the **washer (B)** and **shaft (A)**.

⚠ CAUTION

- Be careful not to drop the **shaft (A)** or hurt your fingers when removing or assembling the **shaft (A)**.
- Make sure the **washer (B)** is in the correct place. If the shaft is fastened without the **washer (B)**, the door may fall and cause injury.

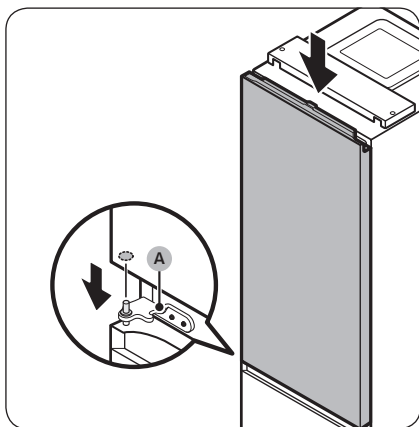

27. Put the fridge door on the **middle hinge (A)**.

⚠ CAUTION

To prevent the fridge door from falling, make sure to hold it tight until the top hinge is fastened.

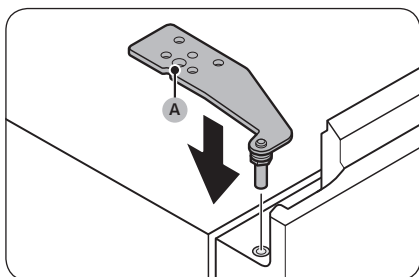

28. Put the **top hinge (A)** on the opposite side to where it was removed.

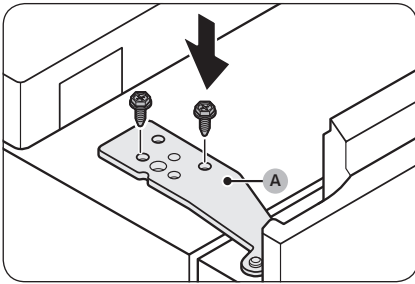

29. Fasten the top hinge (A) with the screws using a socket wrench (8 mm).

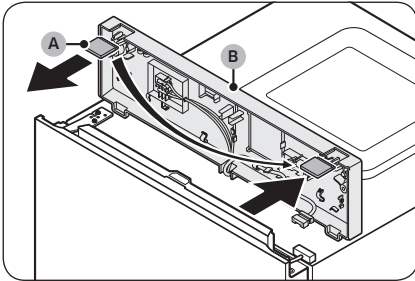

30. Remove the space cover (A) from the top cover (B) and then put it on the opposite side.

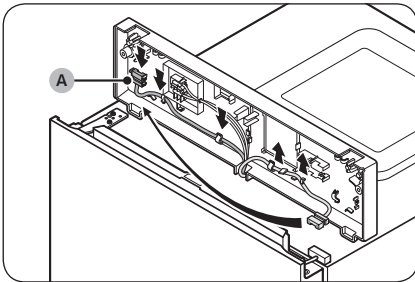

31. Underneath the top cover, pull the wire connector (A) from the holders, and move it to the holders on the opposite side.
- This step may not apply to some models.

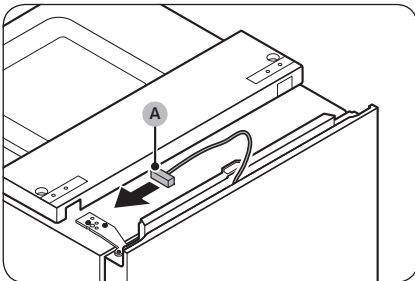

32. Move the wire connector (A) on the fridge door to the opposite side.
- This step may not apply to some models.

Maintenance

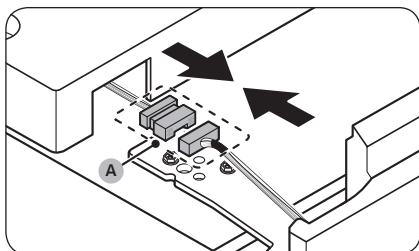

- 33.Reconnect the **wire connector (A)**.
- This step may not apply to some models.

⚠ CAUTION

Make sure the wire connectors are connected properly. Otherwise, the display does not operate.

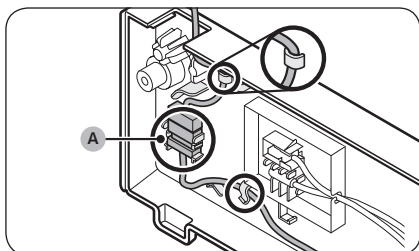

- 34.Place the wire and the **wire connector (A)** on the holder underneath the top cover.
- This step may not apply to some models.

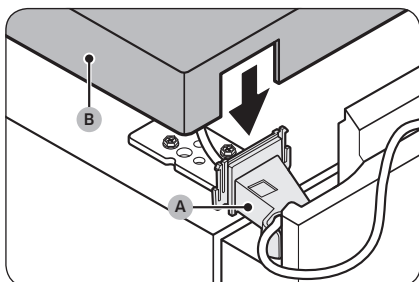

- 35.Attach the provided **top-left hinge cover (A)** to the top hinge and assemble the **top cover (B)**.
- Place the wires and connectors into the **top-left hinge cover (A)** and **top cover (B)**. (Some models does not have wires on the fridge door and this may not apply to those models.)

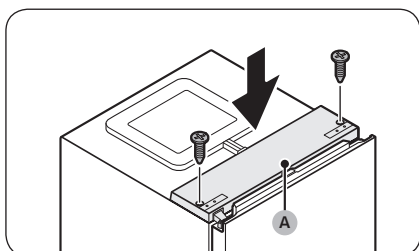

- 36.With the fridge door closed, put the **top cover (A)** back and fasten it with the screws using a Phillips screwdriver.

⚠ CAUTION

Be careful not to damage the wires when fastening the **top cover (A)**.

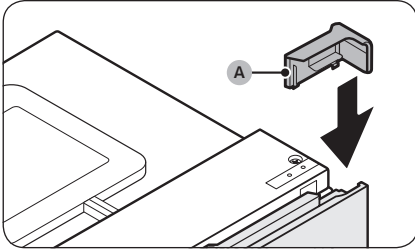

- 37.** Put the provided **top-right door cover (A)** on the opposite side of the door hinge.
- This step may not apply to some models.

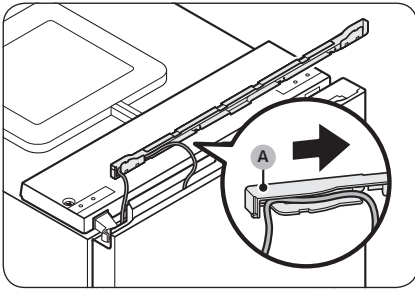

- 38.** Place the wire from the fridge door into the space underneath the **wire cover (A)**.
- This step may not apply to some models.

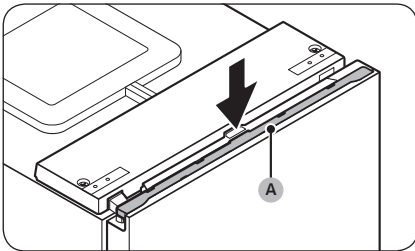

- 39.** Put the **wire cover (A)** back onto the fridge door.
- This step may not apply to some models.
- 40.** Open and close the fridge door a few times to check for any problems.

Maintenance

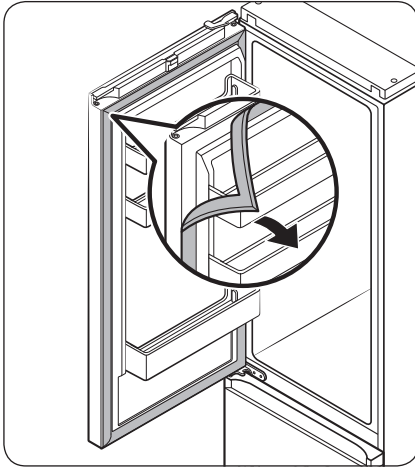

41. Detach the fridge and the freezer door gaskets, and then attach them after rotating them 180°.

⚠ CAUTION

Make sure the door gaskets are properly attached. If not, there can be a noise or dew can be formed which affects performance of the unit.

📖 NOTE

- After reversing the door, adjust the levelling legs to level the refrigerator. (For detailed instruction, see the "STEP 4 Adjust the levelling legs" section on page 33.)
- To return the door to its initial position, follow the steps again. Please note that the door, hinges, and other parts would then be in the opposite orientation as listed in these steps.

Handle and care

Shelves / Rack & Shelf (applicable models only)

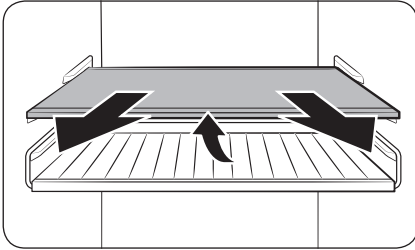

1. Pull out the shelf (or Rack & Shelf) a little. Then, while lifting the rear side, pull out.

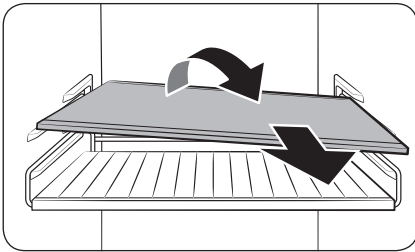

2. Twist the shelf (or Rack & Shelf) diagonally to remove.

Maintenance

Foldable shelf (applicable models only)

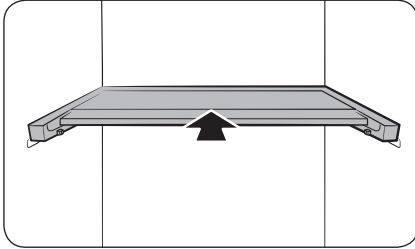

1. Slide the front half of the shelf.

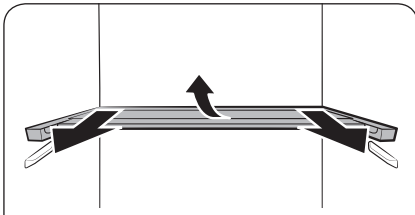

2. Pull out the foldable shelf a little. Then, while lifting the rear side, pull out.
3. Twist the shelf diagonally to remove.

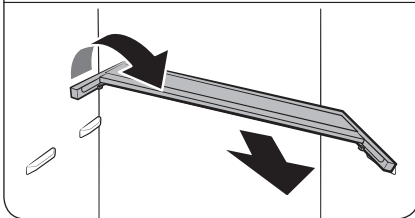

⚠ CAUTION

- Do not put food or objects in front of the Optimal Fresh+. The door may not close properly, and the items may fall down on the floor.
- The shelf must be inserted correctly. Do not insert upside down.
- When reinserting the shelf, make sure to push in the shelf to the end until it fits.
- Glass containers may scratch the surface of glass shelves.

Cleaning

Interior and exterior

⚠ WARNING

- Do not use benzene, thinner, or home/car detergent such as Clorox™ for cleaning purposes. They may damage the surface of the refrigerator and cause a fire.
- Do not spray water onto the refrigerator. This may cause electric shock.

Regularly use a dry cloth to remove all foreign substances such as dust or water from the power plug terminals and contact points.

1. Unplug the power cord.
2. Use a moistened, soft, lint-free cloth or paper towel to clean the refrigerator's interior and exterior.
3. When done, use a dry cloth or paper towel to dry well.
4. Plug in the power cord.

Real panel / Compressor cover (applicable models only)

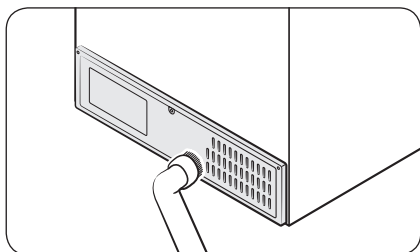

To keep cords and exposed parts of the rear panel free of dirt, vacuum the panel once or twice a year.

⚠ CAUTION

Do not remove the rear panel cover. Electric shock may occur.

Maintenance

Replacement

LED Lamps

To replace the lamps of the refrigerator, contact a local Samsung service centre.

WARNING

- The lamps are not user-serviceable. Do not attempt to replace a lamp yourself. This can cause electric shock.

Lamp (Light Source)

This product contains a light source of energy efficiency class <G>.

The lamp(s) and/or control gear(s) are not user-serviceable. To replace the lamp(s) and/or control gear(s) in the product, contact a local Samsung service centre.

For detailed instructions on replacing lamp(s) or control gear(s) in your product, visit the Samsung website (<http://www.samsung.com>), go to Support > Support home, and then enter the model name.

For detailed instructions on dismantling lamp(s) and/or control gear(s), simply follow the replacement instruction reached as described above.

Door panel (applicable models only)

You can select the door panel you prefer for your BESPOKE refrigerator. Purchase the door panel at a Samsung retail store and an authorized installer will install the panel for you.

CAUTION

- Disassembling or assembling the door panel on your own may result in product damage or personal injury. If you find any problems with the door panel, contact a Samsung service center
- A service fee may be charged for panel replacement even within the warranty period.

Pair installation (applicable models only)

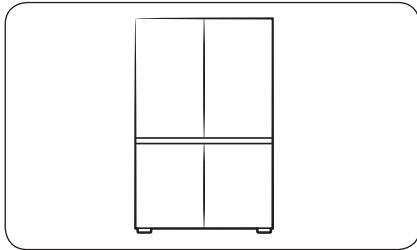

You can install this refrigerator side by side with another Samsung refrigerator if you want. However, the refrigerators must be the BESPOKE models. If you want the pair installation, check if the desired models allow pair installation before purchasing them. You can check it at the retail store or Samsung.com website.

NOTE

- Purchase the pair installation kit at a Samsung retail store and you can request an authorized installer for pair installation.
- Make sure to purchase the appropriate pair installation kit for your model. You must use the dedicated pair installation kit to prevent any installation problem.
 - RB34 model: RA-COOK4BAA
 - RB38 model: RA-COOK3BAA
- Pair installation may increase energy consumption.

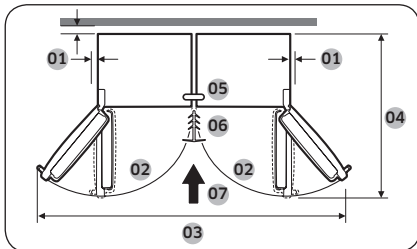

01	more than 50 mm recommended
02	105°
03	1250 mm
04	1212 mm
05	Upper bracket
06	Trim
07	Install direction

Maintenance

Tools required (not provided)



Phillips screwdriver



Flat-head screwdriver

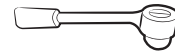

8 mm socket wrench (for bolts)

Pair installation kit accessories

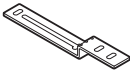

A. Upper bracket (1)



B. Lower bracket (1)

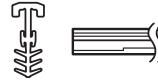

C. Trim (1)

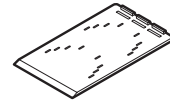

D. A/S Jig-sheet ref (4)



E. Level adjustment pad (4)

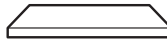

F. T7 LEX foam (8)

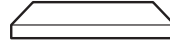

G. T5 PE foam (1)

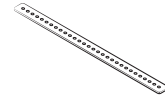

H. Rear bracket (1)



J. M5 x 16 hex screws (4)



K. M4 x 18 screws (2)

NOTE

- The number in parenthesis refers to the quantity of each accessory.
- **Lower bracket (B)** and **Trim (C)** comes in two sizes (7 or 15 mm). Check the sizes when you order the pair installation kit.

Step-by-step instruction

NOTE

The alphabet letters on the figure and in the parenthesis are the same as those in the accessories list.

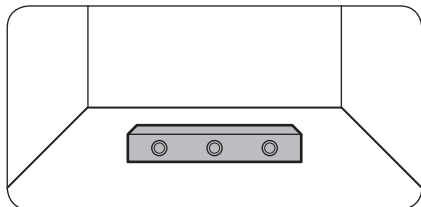

1. Check the level of the floor.
 - Use a level to check the level of the floor where the refrigerator's two rear casters will be placed.

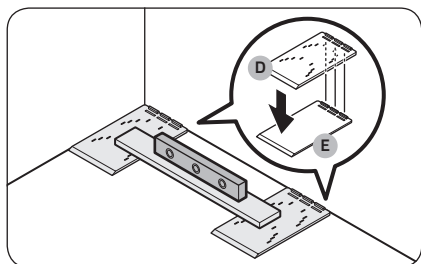

2. Place the A/S jig-sheet refs (D) and check the level.
 - Place the two provided A/S jig-sheet refs (D) on the floor where the refrigerator's two rear casters will be placed, and then check the level.
 - If the floor is not level, put the provided level adjustment pads (E) under the A/S jig-sheet refs (D) so the refrigerator will stand on a level surface.
 - Once you sort out all the necessary parts to level, peel off the double-sided tape on the bottom of each part and attach the part in its final position.

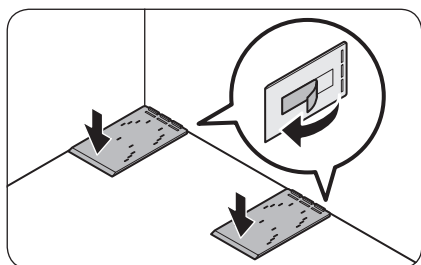

Maintenance

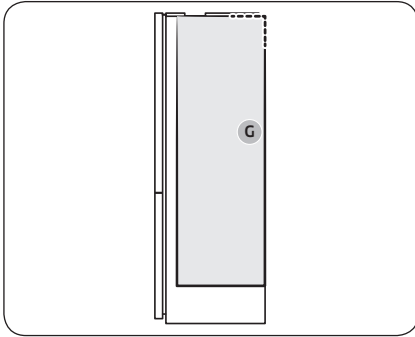

3. Attach the foams to maintain a gap between the two refrigerators.

NOTE

You must attach the **T5 PE foam (G)** to the BMF (Bottom-mounted freezer) model only. (In case you install two different types of refrigerators in pair.)

A. Pair install of RB38 model:

- Attach the **T5 PE foam (G)**.
- See the figure for the position of the foam.

B. Pair install of RB34 model:

- Attach the **T5 PE foam (G)**, and then attach four **T7 LEX foams (F)** on top of the **T5 PE foam (G)**.
- See the figure for the position of the foams.

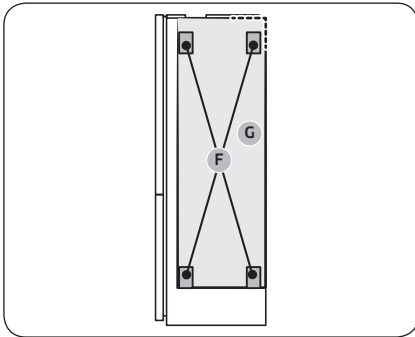

4. Align the two refrigerators.

- Check the alignment at the top and front of the refrigerators and realign them if necessary.

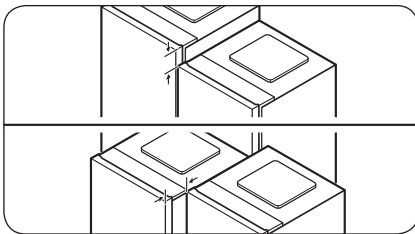

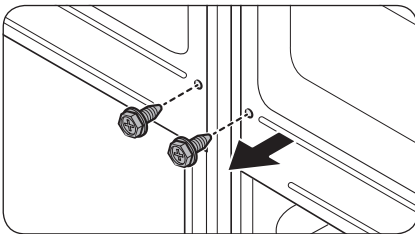
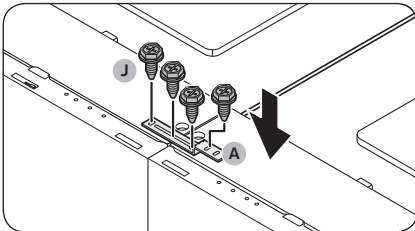
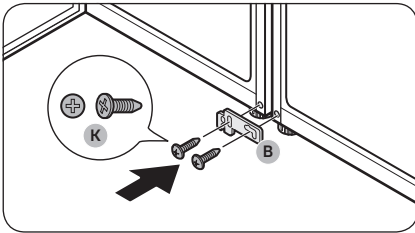
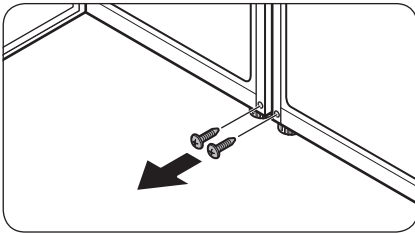

5. Remove the screws from the two holes where the lower bracket will be fastened to.

- Open the door of the refrigerators to be paired, and then remove the screws located where the lower bracket will be fastened.

6. Fasten the lower bracket (B).

- Fasten the lower bracket (B) with the two M4 x 18 screws (K) (one fastened to each refrigerator) to secure the lower parts of the refrigerators.

7. Fasten the upper bracket (A).

- Fasten the upper bracket (A) with the four M5 x 16 hex screws (J) to secure the top part of the refrigerators.

NOTE

Align the tops of the refrigerators before fastening the upper bracket.

8. Remove the screws at the back of the refrigerators.

Maintenance

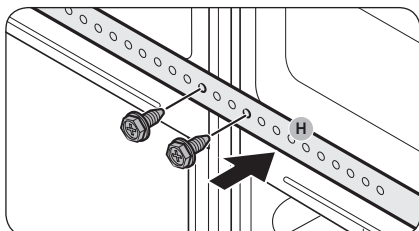

9. Use the screws removed from step 8 to fasten the rear bracket (H).

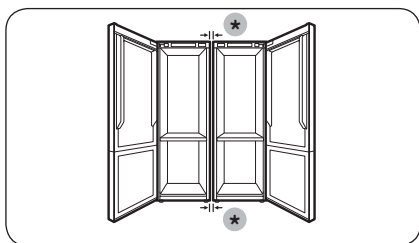

10. Check the spacing between the refrigerators.

- After fastening the upper and lower brackets, make sure the spacing between the refrigerators is 7 or 15 mm at the top and bottom.

(*): 15 mm (RB34) / 7 mm (RB38)

NOTE

If the spacing between the refrigerators is greater than 7 or 15 mm, there may be less room between the refrigerator and the walls (or cabinets), and this may interfere when opening the doors.

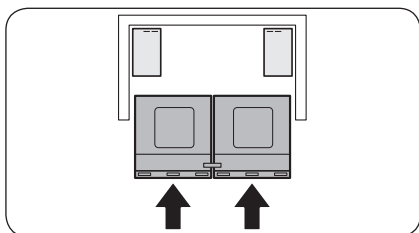

11. Push the refrigerators into the walls (or cabinets).

- Have two people simultaneously push the refrigerators, fixed with brackets, into the walls (or cabinets).

NOTE

If the two people do not push the refrigerators evenly, the rear parts of the refrigerators may spread out or may deviate from their intended spot.

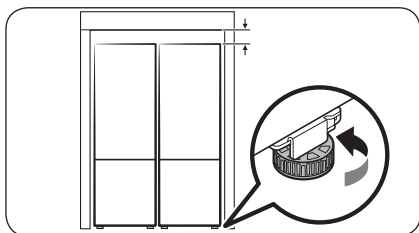

12. Adjust the height of the refrigerators.

- Turn the leveling leg right or left to adjust the height of the refrigerators to be flush with the walls (or cabinets).

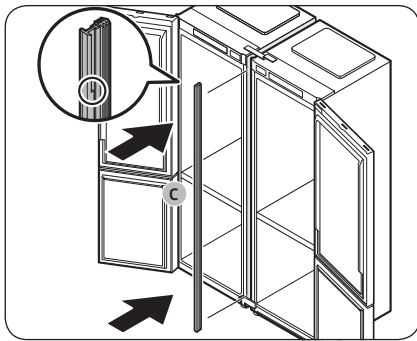

13. Insert the trim (C) between the refrigerators.

- Open the doors and insert the trim (C) between the refrigerators.

NOTE

See the enlarged part of the trim in the figure to identify the trim's top side.

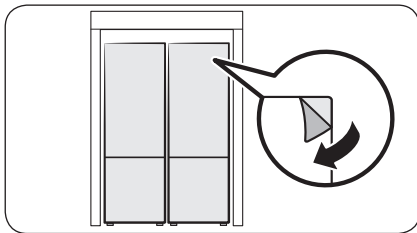

14. Do a final check.

- If there are no problems, peel all the protective film off the product.

Troubleshooting

Before calling for service, review the checkpoints below. Any service calls regarding normal situations (No Defect Cases) will be charged to users.

General

Temperature

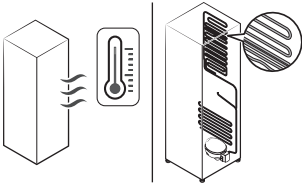
Symptom	Possible causes	Solution
Fridge/freezer does not operate. Fridge/freezer temperature is warm.	<ul style="list-style-type: none"> Power cord is not plugged in properly. 	<ul style="list-style-type: none"> Properly plug in the power cord.
	<ul style="list-style-type: none"> Temperature control is not set correctly. 	<ul style="list-style-type: none"> Set the temperature lower.
	<ul style="list-style-type: none"> Refrigerator is located near a heat source or direct sunlight. 	<ul style="list-style-type: none"> Keep the refrigerator away from direct sunlight or a heat source.
	<ul style="list-style-type: none"> Not enough clearance between refrigerator and sides/rear. 	<ul style="list-style-type: none"> Make sure there are at least 5 cm from the rear and sides.
	<ul style="list-style-type: none"> The Vacation function is activated. 	<ul style="list-style-type: none"> Deactivate the Vacation function.
	<ul style="list-style-type: none"> The refrigerator is overloaded. Food is blocking the refrigerator vents. 	<ul style="list-style-type: none"> Do not overload the refrigerator. Do not allow food to block ventilation.
Fridge/freezer is over-cooling.	<ul style="list-style-type: none"> Temperature control is not set correctly. 	<ul style="list-style-type: none"> Set the temperature higher.
Interior wall is hot.	<ul style="list-style-type: none"> Refrigerator has heat-proof piping in the interior wall. 	<ul style="list-style-type: none"> To prevent condensation from forming, the refrigerator has heat-proof piping in the front corners. If the ambient temperature rises, this equipment may not work effectively. This is not a system failure. 



Odours

Symptom	Possible causes	Solution
Refrigerator has odours.	<ul style="list-style-type: none"> Spoiled food. 	<ul style="list-style-type: none"> Clean the refrigerator and remove any spoiled food.
	<ul style="list-style-type: none"> Food with strong odours. 	<ul style="list-style-type: none"> Make sure strong smelling food is wrapped airtight.

Frost

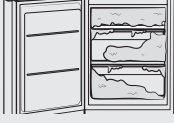
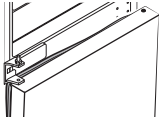
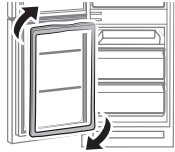
Symptom	Possible causes	Solution
Frost around the vents.	<ul style="list-style-type: none"> Food is blocking the vents. 	<ul style="list-style-type: none"> Make sure no food blocks the refrigerator vents.
Frost on interior walls.	<ul style="list-style-type: none"> Door is not closed properly. 	<ul style="list-style-type: none"> Make sure food does not block the door. Clean the door gasket.
Excessive frost build-ups in the freezer. 	<ul style="list-style-type: none"> The door is not sealing properly because the door gasket was not reversed after reversing the doors.  	<ul style="list-style-type: none"> Detach the door gasket and then attach it after rotating it 180°. 

Condensation

Symptom	Possible causes	Solution
Condensation forms on the interior walls.	<ul style="list-style-type: none"> If door is left open, moisture enters the refrigerator. 	<ul style="list-style-type: none"> Remove the moisture and do not open the door for a long time.
	<ul style="list-style-type: none"> Food with high moisture content. 	<ul style="list-style-type: none"> Make sure food is wrapped airtight.



Troubleshooting

Do you hear abnormal sounds from the refrigerator?

Before calling for service, review the checkpoints below. Any service calls related to normal sounds will be charged to the user.

These sounds are normal.

- When starting or ending an operation, the refrigerator may make sounds similar to a car engine igniting. As the operation stabilizes, the sounds will decrease.

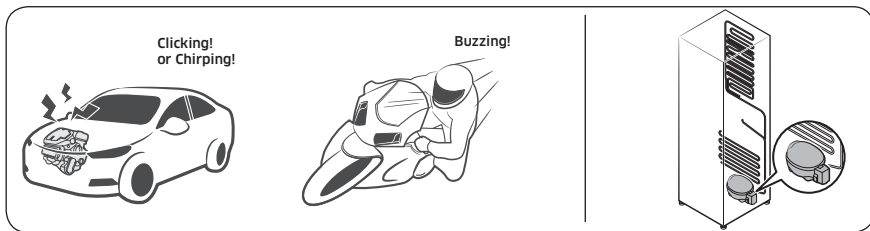

- While the fan is operating, these sounds may occur. When the refrigerator reaches the set temperature, no fan sound will occur.

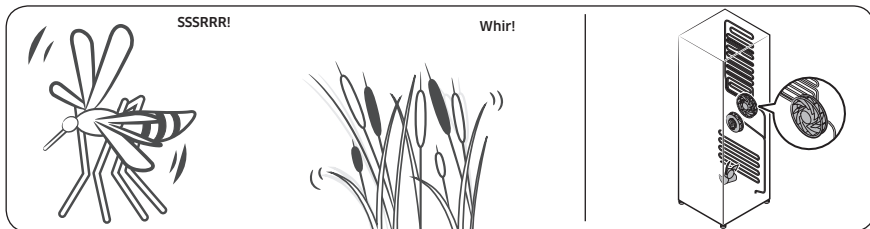

- During a defrost cycle, water may drip on the defrost heater, causing sizzling sounds.



- As the refrigerator cools or freezes, refrigerant gas moves through sealed pipes, causing bubbling sounds.

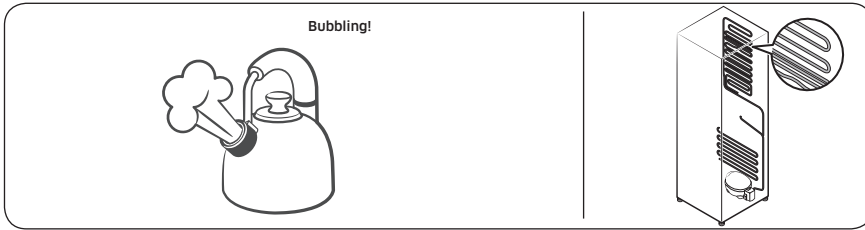

- As the refrigerator temperature increases or decreases, plastic parts contract and expand, creating knocking noises. These noises occur during the defrosting cycle or when electronic parts are working.

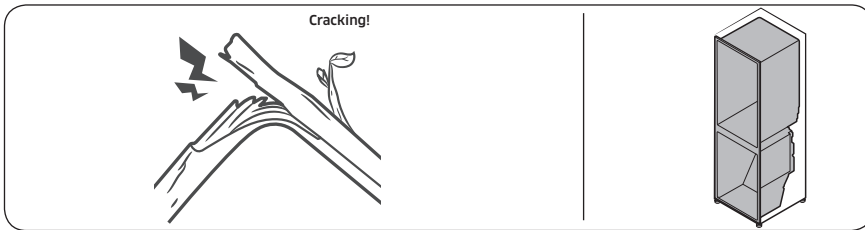

- For ice maker models: When the water valve opens to fill the ice maker, buzzing sounds may occur.
- Due to pressure equalizing when opening and closing the refrigerator door, whooshing sounds may occur.

Troubleshooting

SmartThings (applicable models only)

Symptom	Action
Could not find "SmartThings" in the app market.	<ul style="list-style-type: none">The supporting software version of the SmartThings app is subject to change according to the OS supporting policy the manufacturer provides. In addition, as for the SmartThings app or the functions that the app supports, the new application update policy on the existing OS version can be suspended due to usability or security reasons.
The SmartThings app fails to operate.	<ul style="list-style-type: none">The SmartThings app is available for applicable models only.The old Samsung Smart Refrigerator app cannot connect with Samsung Smart Home models.
The SmartThings app is installed but is not connected to my refrigerator.	<ul style="list-style-type: none">You must log into your Samsung account to use the app.Make sure that your router is operating normally.If the Wi-Fi icon on the refrigerator's display is off, this indicates that no network connection has been established yet. In this case, use the SmartThings app to connect and register your refrigerator to the access point (AP) of your house.
Could not log into the app.	<ul style="list-style-type: none">You must log into your Samsung account to use the app.If you don't have a Samsung account, follow the app's onscreen instructions to create one.
An error message appears when I try to register my refrigerator.	<ul style="list-style-type: none">Easy Connection may fail due to the distance from your access point (AP) or electrical interference from the surrounding environment. Wait a moment and try again.
The SmartThings app is successfully connected to my refrigerator but does not run.	<ul style="list-style-type: none">Exit and restart the SmartThings app, or disconnect and reconnect the router.Power off the refrigerator, and then power it on again after 1 minute.
The Wi-Fi icon is blinking. ()	<ul style="list-style-type: none">Connect your refrigerator with the SmartThings app before use. When the connection is made successfully, the indicator stops blinking.<ul style="list-style-type: none">If you fail to make connection or don't want to use the app, press and hold the > button for 10 seconds. The indicator stops blinking with "O FF" shown on the temperature display.

Appendix

Safety Instruction

- For the most efficient use of energy, please keep the all inner fittings such as baskets, drawers, shelves and ice cube tray on the position supplied by manufacturer.
- This refrigerating appliance is not intended to be used as a built-in appliance.

Install Instruction

For refrigerating appliances with climate class

Depending on the climate class, This refrigerating appliance is intended to be used at ambient temperatures range as specified following table.

The climate class can be found on the rating plate. The product may not operate properly at temperatures outside of the specific range.

You can find climate class on label inside of your refrigerator

Effective temperature range

The refrigerator is designed to operate normally in the temperature range specified by its class rating.

Class	Symbol	Ambient Temperature range (°C)	
		IEC 62552 (ISO 15502)	ISO 8561
Extended Temperate	SN	+10 to +32	+10 to +32
Temperate	N	+16 to +32	+16 to +32
Subtropical	ST	+16 to +38	+18 to +38
Tropical	T	+16 to +43	+18 to +43

NOTE

The cooling performance and power consumption of the refrigerator may be affected by the ambient temperature, the door-opening frequency, and the location of the refrigerator. We recommend adjusting the temperature settings as appropriate.

Appendix

Temperature Instruction

Recommended Temperature

The optimal temperature setting for food storage:

- Fridge: 3 °C
- Freezer: -19 °C

NOTE

The optimal temperature setting of each compartment depends on the ambient temperature. Above optimal temperature is based on the ambient temperature of 25 °C.

Power Cool

Power Cool speeds up the cooling process at maximum fan speed. The fridge keeps running at full speed for two and a half hours and then returns to the previous temperature.

Power Freeze

Power Freeze speeds up the freezing process at maximum fan speed. The freezer keeps running at full speed for 50 hours and then returns to the previous temperature. To freeze large amounts of food, activate Power Freeze for at least 20 hours before putting food in the freezer.

NOTE

When you use this function the energy consumption of the refrigerator will increase. Remember to turn it off when you don't need it and return the freezer to your original temperature setting.

How to store for best preservation (applicable models only)

Cover foods to retain moisture and prevent them from picking up odors from other foods. A large pot of food like soup or stew should be divided into small portions and put in shallow containers before being refrigerated. A large cut of meat or whole poultry should be divided into smaller pieces or placed in shallow containers before refrigerating.

Placement of Foods

Shelves	Shelves should be adjustable to accommodate a variety of packages.
Specialized compartment (applicable models only)	Sealed crisper drawers provide an optimal storage environment for fruits and vegetables. Vegetables require higher humidity conditions while fruits require lower humidity conditions. Crispers are equipped with controls devices to control the humidity level. (*Depending on model and options) An adjustable temperature meat drawer maximizes the storage time of meats and cheeses.

Stored on the door	Don't store perishable foods in the door. Eggs should be stored in the carton on a shelf. The temperature of the storage bins in the door fluctuate more than the temperature in the cabinet. Keep the door closed as much as possible.
Freezer Compartment	You can store frozen food, make ice cubes and freeze fresh food in the freezer compartment.

NOTE

Freeze fresh, undamaged food only. Keep food which is to be frozen away from food which is already frozen. To prevent food from losing its flavour or drying out, place in airtight containers.

Refrigerator & Freezer Storage Chart

The freshness longevity depends on temperature and exposure to moisture. Since product dates aren't a guide for safe use of a product, consult this chart and follow these tips.

Milk products

Product	Refrigerator	Freezer
Milk	1 week	1 month
Butter	2 weeks	12 months
Ice cream	-	2-3 weeks
Natural cheese	1 month	4-6 months
Cream cheese	2 weeks	Not recommended
Yogurt	1 month	-

Meat

Product	Refrigerator	Freezer
Fresh roasts, steaks, chops	3-4 days	2-3 months
Fresh ground meat, stew meat	1-2 days	3-4 months
Bacon	7 days	1 month
Sausage, Raw from pork, beef, turkey	1-2 days	1-2 months

Appendix

Poultry / Eggs

Product	Refrigerator	Freezer
Fresh poultry	2 days	6-8 months
Poultry salad	1 day	-
Eggs, Fresh in shell	2-4 weeks	Not recommended

Fish / Seafood

Product	Refrigerator	Freezer
Fresh fish	1-2 days	3-6 months
Cooked fish	3-4 days	1 month
Fish salad	1 day	Not recommended
Dried or pickled fish	3-4 weeks	-

Fruits

Product	Refrigerator	Freezer
Apples	1 month	-
Peaches	2-3 weeks	-
Pineapple	1 week	-
Other fresh fruit	3-5 days	9-12 months

Vegetables

Product	Refrigerator	Freezer
Asparagus	2-3 days	-
Broccoli, Brussels sprouts, green peas, mushrooms	3-5 days	-
Cabbage, cauliflower, celery, cucumbers, lettuce	1 week	-
Carrots, beets, radishes	2 weeks	-

Information for model and ordering spare parts

Model information

To access the EPREL registration of the model :

1. Go to <https://eprel.ec.europa.eu>
2. Get the model identifier from the energy label of the product and type it in the search box
3. Energy Labelling information of the model is shown

Part information

- The minimum period during which spare parts, necessary for the repair of the appliance, are available
 - 7 Years thermostats, temperature sensors, printed circuit boards and light sources, door handles, door hinges, trays, baskets (boxes or drawers)
 - 10 Years door gaskets
- The minimum duration of the guarantee of the refrigerating appliance offered by the manufacturer 24 Months.
- Relevant information for ordering spare parts, directly or through other channels provided by the manufacturer, importer or authorized representative
- You can find professional repair information on <http://samsung.com/support>. You can find user servicing manual on <http://samsung.com/support>.

Open Source Announcement

(RB38**C****, RB38**8****, RB38**9**** models only)

The software included in this product contains open source software. You may obtain the complete corresponding source code for a period of three years after the last shipment of this product by contacting our support team via <http://opensource.samsung.com> (Please use the "Inquiry" menu.)

It is also possible to obtain the complete corresponding source code in a physical medium such as a CD-ROM; a minimal charge will be required.

The following URL http://opensource.samsung.com/opensource/COMMON_TZ6_0/seq/0 leads to the open source license information as related to this product. This offer is valid to anyone in receipt of this information.



Memo

Memo

Memo

RB38**C****, RB38**8****, RB38**9**** models only

* Asterisk(s) means variant model and can be varied (0-9) or (A-Z).

NOTE

Hereby, Samsung declares that this radio equipment is in compliance with Directive 2014/53/EU and with the relevant statutory requirements in the UK.

The full text of the EU declaration of conformity and the UK declaration of conformity is available at the following internet address: The official Declaration of conformity may be found at <http://www.samsung.com>, go to Support > Search Product Support and enter the model name.

	Frequency range	Transmitter power (Max)
Wi-Fi	2412 - 2472 MHz	20 dBm
Bluetooth	2402 - 2480 MHz	20 dBm

Contact SAMSUNG WORLD WIDE

If you have any questions or comments relating to Samsung products, please contact the SAMSUNG customer care centre.

Country	Contact Center	Web Site
UK	0333 000 0333	www.samsung.com/uk/support
IRELAND (EIRE)	0818 717100	www.samsung.com/ie/support
SINGAPORE	1800 7267864 1800-SAMSUNG (Other) 1800 4252997 1800-GALAXYS (HHP)	www.samsung.com/sg/support



DA68-04111A-08